

ACCESSORIES AND SPARE PARTS

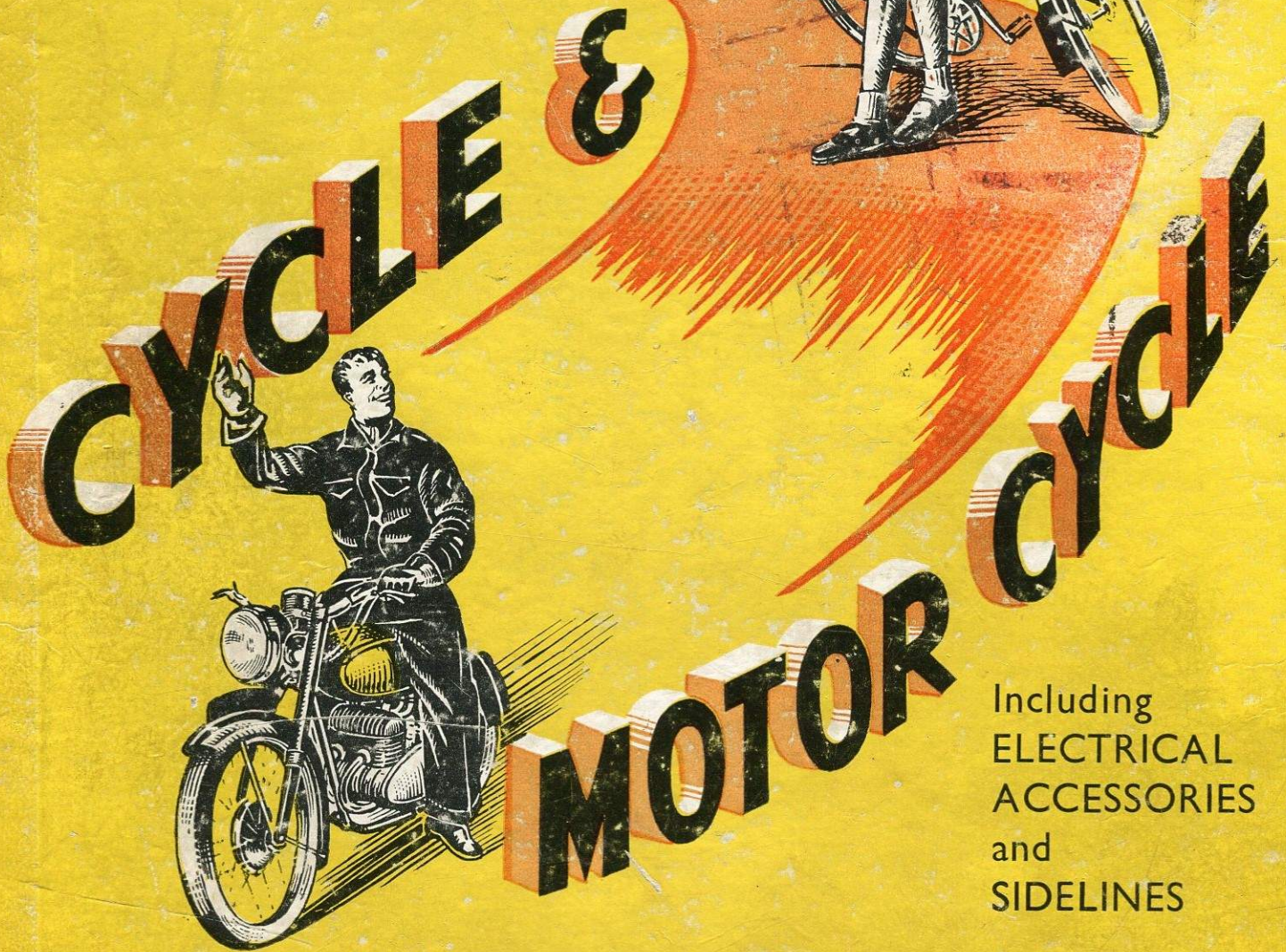

Including
ELECTRICAL
ACCESSORIES
and
SIDELINES

W. G. CHEESE LTD.

JUPITER HOUSE, 326 - 327 BRADFORD STREET
BIRMINGHAM, 5

Telephone : MIDLAND 5804/5 (2 lines)

Telegrams : MIDLAND 5804 BIRMINGHAM

W. G. CHEESE LIMITED

Factors of
**CYCLE AND
MOTOR ACCESSORIES
WIRELESS AND
ELECTRICAL SUNDRIES**

**JUPITER HOUSE
326-327 BRADFORD STREET
BIRMINGHAM 5**

Telephone:
MIDland 5804/5 (2 lines)

Telegrams:
MIDLAND 5804 BIRMINGHAM

TERMS OF BUSINESS

ONLY THE TRADE SUPPLIED

CATALOGUE PRICES

The prices shown in this Catalogue are the latest at the time of printing, but as they are continually fluctuating, it must be clearly understood that they are subject to alteration without notice, and goods will be invoiced at the prices ruling at the date of despatch. While every care has been taken in compiling this Catalogue, no responsibility can be accepted for errors.

PROPRIETARY LINES

Proprietary lines are sold subject to the re-selling Agreements in force by the Manufacturers being strictly adhered to by customers, and the acceptance of the goods will be treated as an acceptance of these conditions.

OPENING ACCOUNTS

Customers desirous of opening Credit Accounts should furnish two trade references. When no credit account has been opened, cash with order will avoid delay in despatch of goods.

REMITTANCES

Cheques, Money Orders, etc. should be made payable to W. G. CHEESE LTD. and crossed. No receipt recognised unless on our numbered and official forms.

SETTLEMENT TERMS

3 $\frac{3}{4}$ % for cash seven days from date of invoice. 2 $\frac{1}{2}$ % for monthly account, payable on the 30th day of month following date of despatch, except where invoices are marked NETT. All accounts under £1 strictly nett. Default in payment against any invoice upon due date shall entitle us without notice to immediate payment of Nett Trade prices as shown in this Catalogue, for all goods subsequent to the date of the invoice upon which default is made and still unpaid for.

ORDERS

The right is reserved to refuse any order given to a representative and no special terms of payment can be recognised unless confirmed in writing mutually.

Orders for goods to special requirements are accepted on the understanding that when such goods are in process of manufacture, or have been specially obtained, cancellation cannot be accepted. In the case of orders for special goods no guarantee can be given or responsibility taken.

All quotations, contracts, delivery promises, are without engagements or responsibility.

It must be distinctly understood, and is a condition of sale, that in regard to all goods sold, no liability is undertaken for consequential damages of any description. No guarantee is given with any goods, but replacements will be obtained from the manufacturers on behalf of customers, if at all possible. Telephone or Telegraph Orders should always be confirmed in writing, the same day, and marked "Confirmation". (If not so marked, responsibility cannot be accepted if the order is duplicated.)

Acceptance of cancellation of orders by telephone cannot be guaranteed.

TERMS OF BUSINESS *{continued}*

CARRIAGE

Until further notice **orders of £4 value** and upwards sent carriage paid by Goods Train in Great Britain or free delivery by our own van when possible.

Certain goods must of necessity be excepted on proprietary lines supplied according to the Manufacturers' terms and conditions and some of these included in the exceptions are:—**Accumulators, Acid, Carbide and Distilled Water.** This list of exceptions may be altered or added to from time to time with or without notice.

COMPLAINTS, SHORTAGES, AND RETURNS

No claims for errors, deficiency, or allowance can be entertained unless made immediately upon receipt of goods or Invoice. Reference No. and date of invoice must always be quoted. Goods correctly despatched to customer's order cannot be returned except by arrangement, and right is reserved to refuse to accept the return of such goods. If by arrangement goods are returned, advice must be sent giving reason for returning, date and Invoice number upon which charged. Unless these conditions are complied with credit will not be passed. No returns will be accepted unless they arrive Carriage Paid. Customer's name and address must in all cases be enclosed with returned goods for identification purposes.

PACKING AND TRANSIT

Boxes, Cases, etc. are charged at cost price and will be credited in full (unless invoice is marked "Not Returnable") if returned in good condition, carriage paid home and advised **within fourteen days** of despatch of goods. All goods are carefully packed and consigned in good condition. They are signed for as such by the Carriers who are then responsible. In the event of any goods arriving short or in bad condition, it is necessary for customers to sign for them as "Damaged" or "Unexamined" on the Carrier's sheet and claim from the Carriers. All claims for loss or damage in transit must be made **within three days** from receipt of goods or claim may not be recognised.

W. G. CHEESE LTD.

PRIVATE & CONFIDENTIAL

FOR THE USE OF THE TRADE

The information on this sheet is for the use of the Trade only, and should not be open to view by the customer.

The usual style of Pricing System, showing Trade and Retail Prices, is shown in this Publication.

Trade Prices are given in code and are indicated by the numbers which follow the List Numbers. To find the Trade Price, read the last two figures as pence, the remainder as shillings.

THUS:—

Page 9	B195/304	each 5/-
		Indicates B195			
		Trade Price 3/4		Retail Price 5/-	
Page 20	C23/1608	each 25/-
		Indicates C23			
		Trade Price 16/8		Retail Price 25/-	

Where there is no concealed price like the above examples, a discount is indicated by an Initial Letter, following the List numbers, which shows the percentage discount off the retail prices.

EXAMPLES

A indicates 10%	J indicates 30%
C indicates 15%	K indicates 33 $\frac{1}{3}$ %
E indicates 20%	L indicates 40%
G indicates 25%	JXX indicates 37 $\frac{1}{2}$ %

PURCHASE TAX.—Prices shown do NOT include Purchase Tax except where stated.

	Page		Page		Page
A					
A.C. Buzzers	47, 92	Baycliff Pannier Bag Carriers	7	Britax Reflectolite	94
Acumen Horns	47	Baycliff Seat Covers	72	Britax Twist Grips	103
Acumen Mirrors	96	Baycliff Straps	76, 107	Brooks Bag Supports	9
Adaptors, Inflator	114	Baycliff Touring Bags	8	Brooks Carriers	19
Adhesives	90, 100	Bedlights, Pifco	121	Brooks Mudflaps	61
Adie Bells	10	Belco Brushing Cellulose... ..	28	Brooks Nipple Key	74
Adie Locks	60	Bell Crank Bolt Unit	17	Brooks Panniers	6
Adjustable Spanners	74	Bell Crank Lever Unit	17	Brooks Saddles	70
Adjusters, Chain	23	Bell Cranks	17	Brooks Scooter Bags	102
Aerialite Aerial Wire	114	Bells	10	Brooks Spanners	73, 74
"Aerite" Foot Pumps	102	Benelux Bumper	34	Brooks Toe Clips and Straps	76, 77
Air Gun Darts, Pellets and Slugs	114	Benelux Chain Shifters	35	Brooks Touring Bags	6
Aireze Pumps	67	Benelux Freewheels	34	Brooks Tyre Levers	78
Airlite Hubs	49	Benelux Gear Spares	35	Brushes, Paint	3, 28
A.J.S. Carrier	20	Benelux Gears	34	Brushing Cellulose, Belco	28
Albion Brake Blocks and Shoes	11	Bends, Handlebar	43, 44	Bulb and Battery Tester	51
Albion Football Lacing Awl	114	Bescol Kettles	118	Bulb Horns	47, 92
Albion Lubricators	60	B.H. Hubs	49	Bulbs, House	114
Albion Nipple Keys	74	B.H. Spindles	30	Bulbs, Lamp	50-52, 86
Albion Nipples	19	Beluxes, Electric	114	Butlers Fog Lamps	93
Altenburger Gears	34	Blocks, Brake	1, 11, 12	Butlers Pass Lamps	93
Aluminium Paint	28	Bluecol, Anti-Freeze	107	Butlers Spot Lamps	93
Anchors, Brake	12	Bluemels Extensions	62	Buttons, Horn	1
Andycycle Gloves	116	Bluemels Inflator Connections	66, 102	Buzzers	47, 92
Ankle Socks	4, 27	Bluemels Mudflaps	61	B.W. Axles... ..	29
Anti-Freeze	107	Bluemels Mudguard Components	62	B.W. Bottom Bracket Axles	29
Apex Mirrors	60	Bluemels Mudguards	61, 62	B.W. Bottom Bracket Cups	29
Apex Mudguards	63	Bluemels Number Plates... ..	97	B.W. Bottom Bracket Lock Rings	29
Apex Pumps	67, 102	Bluemels Pump Washers... ..	68	B.W. Bracket Axle Units	29
Artist Brushes	28	Bluemels Pumps	67, 102	B.W. Freewheels	33
Ashby "Babscar" Carriers	21	Bluemels Reflectors	68	B.W. Hub Cones	30
Ashby Bag Supports	9	B.M.B. Ballpaks	7	B.W. Hub Spindles	30
Ashby Carriers	9, 20, 21	Bobby Caps	5, 26	B.W. Hubs... ..	48
Ashby Chairs	115	Bolts, Expander	44, 45	B.W. Sprocket Lock Rings	33
Ashby Cycle Stands	75	Bolts, Seat	2, 72		
Ashby Lamp Brackets	58	Boots, Rubber	103	C	
Ashby Roller Skates	123	Bostik Adhesives	90	Cable Brake Leg Springs	19
Ashby Spanners	73	Bostik Clear Adhesive	100	Cable Brake Levers	13, 15, 16
Ashby Tables	115	Bostik Sealing Compounds	90	Cable Brakes	13, 15
Ashby Toe Clips	76	Bottle Carriers	22	Cable Clips	11
Ashby Trade Carriers	20	Bottle Corks	22	Cable Nipples	19
Aston Dress Guards	25	Bottles, Coloral	22	Cable Transmission	16
Astral Lighter Flints	115	Bottles, Water	22	Cables, Brake	14, 15
Astral Spin Dryers	123	Bottom Bracket Axles	29	Cables, Control	89
Autobright Polish	99	Bottom Bracket Cups	29	Camden Saddles	72
Autochrome	100	Bottom Bracket Lock Rings	29	Campagnolo Hubs	49
Avon Tyres and Tubes	80, 110	Box Batteries	50	Campagnolo Seat Pillars	72
Axle Units, Bracket	29	Box Spanners	108	Canex Saddle Covers	72
Axles, Bottom Bracket	29	Bracket Axle Units	29	Cans, Oil	60
Axles, Racing	29	Bracket Cups, Bottom	29	Capes	5, 26
		Brackets, Lamp	58, 59	Caps, Dust... ..	66, 109
		Brake Anchors	12	Caps, End	112
		Brake Blocks and Shoes	1, 11, 12	Caps, Ski	27
		Brake Cable Clips... ..	11	Caps, Valve	109
		Brake Cables	14, 15	Caps, Woollen Bobby	5, 26
		Brake Fluid, Hydraulic	98	Carriers	9, 19-22
		Brake Hood Rubbers	12, 47	Carriers, Child	21
		Brake Leg Springs... ..	19	Carriers, Feeding Bottles	22
		Brake Leg Units	18	Carriers, Pannier	7-9
		Brake Lever Sleeves	12, 46	Carriers, Tradesmens	20
		Brake Levers	13, 15, 16, 95	Cases, Pannier	7-9
		Brake Linings	87	Castrol Oils and Greases... ..	98
		Brake Shoes	11, 18	Celluloid Pumps	3
		Brake Shoes Relined	11	Cement, Rim	79
		Brake Spares	13-19	Cements, Jointing... ..	90
		Brake Springs	17	Centre Bolt Units... ..	18
		Brake Stirrups	16, 18	Chain Adjusters	23
		Brakes	13, 15, 16	Chain Guards	25
		Brampton Ball Head Clips	30	Chain Pins and Nuts	23
		Brampton Chains	23	Chain Rivet Extractors	23, 87
		Brampton Chainwheels	24	Chain Shifters	35
		Brampton Head Fittings	29	Chains and Chain Spares	23, 87
		Brampton Pedal Dust Caps	66		
		Brampton Pedals	65		

W. G. CHEESE LIMITED
 CYCLE AND MOTOR ACCESSORIES, WIRELESS
 AND ELECTRICAL SUNDRIES

JUPITER HOUSE
 326-327, BRADFORD ST., BIRMINGHAM, 5
 Telephone: MIDland 5804/5 (2 lines)

	Page		Page		Page
Fluorescent Tubes	115	Handlebar Switches	94	Johnsons Car Plate Cleaner	99
Fog Lamps	93	Handlebar Tape	5, 46	Johnsons Chrome Cleaner	99
Folding Chairs and Tables	115	Handlebars...	45	Johnsons Deep Gloss Carnu	99
Foot Pumps	102	Head Ball Races	30	Johnsons One-Step Polish	99
Football Adaptors	114	Head Clips, Ball	30	Jointing Cements	90
Football Bladders	114	Head Fittings	29	Jupiter Capes	26
Football Lacers	114	Head Lamps	53-56	Jupiter Handlebar Bends and Stems	43, 44
Footballs	114	Head Lock Nuts	29	Jupiter Hub Spindles	30
Footrests	90	Head and Lock Ring Spanners	73	Jupiter Leggings	27
Fork Clips and Pins	17	Headlamp Brackets	58, 59	Jupiter Rim Tapes	68
Forks	31, 90	Heaters, Electric	116-118		
Four-in-One Socket Wrenches	2, 73, 108	Heaters, Infra-Red	116	K	
Frames	32	Heaters, Oil	90	Kangaroo Enamel Brushes	28
Freewheel Remover	32	Heaters, Paraffin	116	Karpol	99
Freewheels and Sprockets	33, 34	Heaybeard Battery Chargers	86	Karwad Car Polish	100
French Chalk	79, 109	Helmets	88	Kayay Licence Holders	95
Frido Adaptor	114	Hermatite Liquid Jointing	90	Kayay Rearguard	94
Frido Footballs	114	Hi-Ten Box Spanners	108	Kaylee Transfers	77
Front Fork Brackets and Springs	17	Hills Number Plates	97	Kettles	118
Front Forks	31	Hills Starlicators	57	Keys, Spoke Nipple	2, 74
Front Hubs	33-40, 48, 49	Hoffmann Steel Balls	7	Kimlite Lamp	55
Front Lamps	53-57	Holdings, Licence	95	King Air Gun Slugs	114
Fuse Wire	124	Holts Windo-Glo	100	Kingston Oil Cans	60
		Holts Wondarchrome	100	Kingston Water Bottles	22
G		Hooters	47, 92	Kingston Wheels	83
Gasket Goo	90	Horn Buttons	1, 92	K.L.G. Sparking Plugs	104
Gaslighter, Ever Ready	51, 115	Horn Switches	94	K.L.G. Suppressor Covers	104
Gauges, Feeler	108	Horns	47, 92	Kwiz Dart Flights	115
Gauges, Tyre	109	Hub Brakes	16	Kwiz Darts...	115
G.B. Brake Blocks and Shoes	11	Hub Cogs	33		
G.B. Brake Hood Rubbers	12	Hub Nuts	30	L	
G.B. Brake Spares...	13	Hub Spares	33-42	Lacquer	28
G.B. Cable Brakes	13	Hub Spindle Units	30	Lacrinoind Polythene Oilcans	60
G.B. Handlebars and Stems	44	Hub Sprockets	33	Lamp Batteries	58, 59
G.B. Levers	13	Hub Wing and Track Nuts	30	Lamp Brackets	50-52
G.B. Wing Nuts	30	Hubs	33-40, 48, 49	Lamp Bulbs	52
Gear Controls	35, 39	Humbrol Art Oil Enamel	28	Lamp Glasses	52
Gear Spares, Sturmey-Archer	36-42	Humbrol Grease	99	Lamp Lens and Tops	52
Gears and Spares	33-42	Humbrol Learner Plates	95	Lampholders	124
Glasses, Lamps	52	Huret Speedometers	74, 107	Lamps, Battery	119-121
Gloves	27, 88, 116	Hydraulic Brake Fluid	98	Lamps, Dynamo	53-57
Goggles	91	Hydrometers	86	Lamps, Fog	93
Goodyear Tyres and Tubes	110			Lamps, Front	53-57
Gramophone Needles	116	I		Lamps, Parking	92, 93
Gramophone Springs	116	I.C.I. Liquid Polish No. 7...	99	Lamps, Rear	53-57, 92, 94
Graphite Grease	98	Impex Dynamo Sets	54	Lamps, Spot	93
Grease	98, 99	Inflator Adaptor	114	Lamps, Stop	94
Grease Guns	92	Inflator Connections	2, 66, 102	Lamps, Tail...	53
Grease Nipples	60	Inflators	3, 67, 102	Lanterns	121
Gre-Solvent Paste...	100	Infra-Red Heaters	116	Lapize Toe Straps	75, 77
Grinding Tool, Valve	112	Insulated Staples	124	Leather Pump Washers	68
Grips, Brake Hood	47	Insulating Tape	76	Leather Straps	76, 107
Grips, Handlebar and Sleeve	46, 47	Iron Elements	118	Leco Cross-Bar Seat	21
Grips, Twist	103	Irons	118	Leco Kiddy Carriers	21
Grubb Electric Heaters	116			Leco Pram Set	21
Guards, Chain and Dress	25	J		Leco Safety Seats	21
Glue, Croid	124	Jackets	4, 26	Leco Top Tube Saddle and Footrest	20
Gunk D.P. Solution	100	J.A.P. Head Fittings	29	Leg Shields...	98
Guns, Grease	92	Jelly, Petroleum	107	Leggings...	26, 27
		Jenograph Graphite Grease	98	Lenco Handlebar Stems	44
H		Jenolite Rust Remover	28, 100	Levers, Brake	13, 15, 16, 95
Hacksaw Blades	92	John Bull Brake Blocks	11	Levers, Clutch	95
Haden Forks	31	John Bull Brake Cable Clips	11	Levers, Tyre	1, 78, 112
Hand Cleaners	100	John Bull Handlebar Grips	46	Licence Holders	95
Hand Lamps	121	John Bull Mudflaps	61	Lifeguard Liquid Polish	100
Handlebar Baskets	8	John Bull Pedal Rubbers	61	Lighting Sets, Dynamo	53, 54
Handlebar Bends and Stems	43, 44	John Bull Repair Outfits	79, 109	Limpet Paint	28
Handlebar End Plugs	46, 47	John Bull Rubber Solution	79	Limpet Transfer Varnish	28
Handlebar Grips	46, 47	John Bull Tyres	80	Linco Spanners	73
Handlebar Muffs	61, 92	Johnsons Car Plate	99	Linings, Brake	87

	Page		Page		Page
Liquid Jointings ...	90	Miller Stop Switches ...	94	Patches, Tyre ...	78, 109
Lloyds Bag Support ...	9	Mirrors ...	60, 96, 97	Pedal Cones ...	66
Lloyds Carriers ...	9, 20	Mitts, Track ...	4, 27	Pedal Dust Caps ...	66
Lock Nuts, Head ...	29	Monobright Heaters ...	116	Pedal Lock Nuts ...	65
Lock Nuts, Pedal ...	65	Monovector Heaters ...	116	Pedal Rubbers ...	66
Lock Rings, Bottom Bracket ...	29	Moped Covers and Tubes ...	110	Pedal Spanners ...	74
Lock Rings, Sprocket ...	33	Moped Pannier Bags ...	4, 7, 101, 102	Pedal Spindles ...	65
Lockheed Hydraulic Brake Fluid ...	98	Morphy-Richards Electric Blankets ...	114	Pedals ...	64, 65
Locks, Cycle ...	59, 60	Morphy-Richards Electric Fires ...	117, 118	Peg and Cone Spanners ...	73
Lodge Sparking Plugs ...	105	Morphy-Richards Electric Irons ...	118	Pennants ...	66
Lodge Terminal Covers ...	105	Morphy-Richards Electric Toaster ...	123	Perry Chains and Spares ...	23, 87
Longbro Box Spanners ...	108	Morphy-Richards Hairdryer ...	116	Perry Hub Coaster Brake ...	16
"L" Plates ...	3, 95	Morphy-Richards Iron Stands ...	118	Perry Hub Sprockets ...	33
Lubricants ...	98, 99	Morphy-Richards Suction Cleaner ...	123	Peters Lamp Brackets ...	53
Lubricators, Spring Lid ...	60	Motoplas Mirrors ...	97	Peters Shoe Plates ...	77
Lucas Battery Case Sets ...	53	M.P. Chains ...	23	Petroleum Jelly ...	107
Lucas Battery Filler ...	86	M.P.C. Mirrors ...	97	Philco Cable Brakes ...	15
Lucas Bells ...	10	M.P.C. Saddles ...	103	Philco Frames ...	32
Lucas Bulbs ...	52	M.P.C. Windscreens ...	112	Philco Front Forks ...	31
Lucas Cyclometers ...	25	Mudguard Extensions ...	62	Philco Pedals ...	64
Lucas Dynamo Sets ...	53, 57	Mudguard Flaps ...	61	Phillips Bell Crank Bolt Units ...	17
Lucas Dynamos ...	53, 57	Mudguards ...	61-63	Phillips Bell Crank Lever Units ...	17
Lucas Gift Sets ...	57	Muffs ...	61, 92	Phillips Bell Cranks ...	17
Lucas Lamp Spares ...	57	Multicore Solder ...	92	Phillips Brake Blocks and Shoes ...	11, 18
Lucas Lamps ...	53			Phillips Brake Leg Units ...	18
Lucas Locks ...	60			Phillips Brake Levers ...	15-17
Lucas "Minilamp" ...	53			Phillips Brake Springs ...	17
Lucas Reflectors ...	68			Phillips Brake Stirrup Unit ...	18
Lucas Tail Lamps ...	53			Phillips Brake Tube Unit ...	18
Lucifer Dynamo Sets ...	54			Phillips Brakes ...	15, 16
Luggage Elastics ...	77			Phillips Cable Brake Leg Springs ...	19
Lycett Dual Seat ...	103			Phillips Centre Bolt Units ...	18
Lycett Pillion Footrests ...	90			Phillips Chain Adjusters ...	23
Lycett Saddles ...	71, 103			Phillips Chain Guards ...	25
Lycett Scooter Bags ...	102			Phillips Connection Screw Units ...	18
Lyvia Mirrors ...	60, 96			Phillips Cycle Stands ...	75
				Phillips Eight-in-One Spanner ...	73
				Phillips Expander Bolts ...	45
				Phillips Fork Clips and Pins ...	17
				Phillips Front Brake Stirrups ...	17
				Phillips Front Forks ...	31
				Phillips Handlebars, Bends and Stems ...	43-45
				Phillips Head Fittings ...	29
				Phillips Lamps ...	53
				Phillips Pedal Cones ...	66
				Phillips Pedal Dust Caps ...	66
				Phillips Pedal Lock Nuts ...	65
				Phillips Pedal Rubbers ...	66
				Phillips Pedal Spindle Units ...	65
				Phillips Pedals ...	64
				Phillips Plunger Rods and Arms ...	17
				Phillips Roller Skates ...	123
				Phillips Seat Pillars ...	43
				Phillips Stud Units ...	17
				Phillips Top Joint Pin, Nut and Washer ...	18
				Phillips Top and Swivel Joints ...	18
				Phillips Transmission Cables ...	16
				Philrace Frames ...	32
				Pifco Bedlights ...	121
				Pifco Bulb and Battery Tester ...	51
				Pifco Electric Blankets ...	114
				Pifco Electric Shavers ...	122
				Pifco Fairylights ...	121
				Pifco Flasher ...	121
				Pifco Flashlamp Bulbs ...	52
				Pifco Flex ...	118
				Pifco Fuse Wire ...	124
				Pifco Headlamps ...	55, 56
				Pifco Horns and Hooters ...	47
				Pifco Iron Elements ...	118
				Pifco Lanterns ...	121
				Pifco Nursery Lamps ...	121
				Pifco Rear Lamps ...	56
				Pifco Staples ...	124

N

O

P

	Page		Page		Page
Pifco Torches	120	Radsport Plug Spanners	1	Seats, Dual	103
Pifco Two-Way Adaptors	124	Radsport P.V.C. Capes	5, 26	Setscrews and Nuts	103
Pillars, Seat	43, 44, 72	Radsport P.V.C. Spattees	5, 26	Shampoos	100
Pillion Footrests	90	Radsport P.V.C. Tape	5, 46	Shavers, Electric	122
Pins, Chain	23	Radsport Reflectors	2, 68	Shifters, Chain	35
Pins, Cotter and Split	3	Radsport Scooter Bags	102	Shim Car Shampoo	100
Pins, Crank Cotter	3	Radsport Screwdrivers	1, 74, 108	Shockstop Brake Hood Grips	47
Plastic Cycle Grips	46	Radsport Seat Bolts	2, 72	Shockstop End Plugs	47
Plastic Handlebar Tapes	5, 46	Radsport Track Mitts	4, 27	Shockstop Handlebar Grips	47
Plates, "L"	3, 95	Radsport Track Nuts	3, 30	Shockstop Sleeve Grips	47
Plates, Registration	97	Radsport Touring Shoes	5, 27	Shoe Plates	2, 27, 77
Plates, Shoe	2, 27, 77	Radsport Tyre Levers	1, 78	Shoes, Brake	11, 18
Plug Covers	104-106	Radsport Wing Nuts	3, 30	Shoes, Touring	5, 27
Plug Spanners	1	Radsport Wollen Bobby Caps	5, 26	Shoes, Track	5, 27
Plugometer	106	Rainmaster Mudguards	63	Shoulder Bags	7
Plugs, Electric	124	Raleigh Cycle Stands	75	Shuresta Cycle Stands	75, 107
Plugs, Handlebar End	46, 47	Raleigh Oil	98	Shuresta Stabilizer	75
Plugs, Sparking	104-106	Raydyot Dipping Switch	94	Simoniz Bodysheen	99
Plunger Rods and Arms	17	Raydyot Licence Holders	95	Simoniz Chrome Cleaner	99
Polishes	99, 100	Raydyot Mirrors	96	Simoniz Liquid Kleener	99
Polythene Bottles	22	Raydyot Oil Heaters	90	Simoniz Paste Kleener	99
Portable Radios	122	Raydyot Spotlamps	93	Simoniz Speedwax	99
Pram Brakes	123	Ray-O-Vac Batteries	50	Simoniz Wax	99
Pram Nets	123	Rear Hubs	48, 49	Simplex Bottles	22
Pram Sets	21	Rear Lamps	53-57, 92, 94	Simplex Cranks	24, 25
Pram Sleevings	46	Reflectors	2, 68	Simplex Gears and Freewheels	34
Prop Stands	75	Regina Freewheels	33	Skates, Roller	123
Pulley Rubbers, Dynamo	53	Registration Plates	97	Ski-Caps	27
Pump Clips	66	Removers, Rust	28, 99, 100	Sleeve Grips	46, 47
Pump Connections	2, 66, 102	Renold Chain Rivet Extractor	23, 87	Slick Cylinder Black	28
Pump Washers	68	Renold Chains and Spares	23, 87	Smith's Bag Supports	9
Pumps, Tyre	3, 67, 102	Repair Outfits, Tyre	78, 79, 109	Smith's Lamp Brackets	59
P.V.C. Capes	5, 26	Resilion Brake Cables	15	Smith's Speedometers	74, 107
P.V.C. Spattees	5, 26	Resilion Brakes	15	Smith's Toe Clips	77
P.V.C. Tape	5, 46	Resilion Cones	30	Socket Wrenches	2, 73, 108
		Resilion Hubs	48	Socks, Ankle	4, 27
R		Resilion Pedals	65	Solder	92
Races, Ball	30	Resilion Spindles	30	Solderless Nipples	19
Racing Axles	29	Rim Cement	79	Solution, Rubber	79, 109
Radio Batteries	50	Rim Tapes	68	Songster Gramophone Needles	116
Radios	122	Rim Truers	84	Sou'westers	26
Radnall Spanner Sets	108	Rims	69, 111	Spanners	2, 4, 5, 73, 74, 108
Radsport Adjustable Spanners	74	Ring Spanners	73	Spanners, Plug	5
Radsport Ankle Socks	4, 27	Rings, Bottom Bracket Lock	29	Sparking Plugs	104-106
Radsport Aspirant Track Shoes	5, 27	Rings, Sprocket Lock	33	Spattees	5, 26
Radsport Brake Blocks and Shoes	1, 11	Rivet Extractors, Chain	23, 87	Speedometers	74, 107
Radsport Campianato Shoe Plates	2, 27	Robbialac Lacquer	28	Speedwell Number Plates	97
Radsport Celluloid Pumps	3, 67	Roller Skates	123	Spin Dryers	123
Radsport Cycle Bags	4, 8	Romac Repair Outfits	79, 109	Spindles, Hub	30
Radsport Dipping Switches	1, 92	Rosa Rim Truers	84	Spindles, Pedal	65
Radsport Dumbbell Spanners	2, 73, 108	Rubber Boots	103	Splendour Bulbs	86, 114
Radsport Elastic Straps	77, 107	Rubber Rim Tapes	68	Splendour House Bulbs	114
Radsport Elite Connections	2, 66, 102	Rubber Solution	79, 109	Spoke Nipple Keys	2, 74
Radsport Elite Crank Cotters	3	Rubber Valve Tubing	79	Spokes and Nipples	69
Radsport Fawn Capes	5, 26	Rubbers, Pedal	66	Spontex Car Sponges	100
Radsport Fawn Overtrousers	5, 26, 27	Rust Removers	28, 99, 100	Spot Lamps	93
Radsport Feeding Tubes	2, 22			Spot Lights	93
Radsport Feeler Gauges	108	S		Spring Forks	31, 90
Radsport Four-in-One Socket Wrenches	2, 73, 108	Saddle Bags	4, 6	Spring Lid Lubricators	60
Radsport Horn Buttons	1, 92	Saddle Covers	72	Springs, Brake	17
Radsport Hurricane Motor Cycle Suit	88	Saddle Spares and Springs	72	Springs, Saddle	72
Radsport Jacket	4, 26	Saddles	3, 21, 70-72	Sprocket Lock Rings	33
Radsport "L" Plates	3, 95	Schrader Valve Caps	109	Sprockets and Freewheels	33, 34
Radsport Lewis Shoe Plates	2, 27	Schrader Valve Cores	109	Squire Locks and Chains	59
Radsport Mattress Saddles	3, 70	Scooter Bags	102	Stadium Dipper Switch	94
Radsport Moped Pannier Bags	4, 7, 102	Scooter Suits	88	Stadium Goggles	91
Radsport Moped Scooter Suit	88	Scotts Dartboards	115	Stadium Helmets	88
Radsport Nipple Keys	2, 74	Screwdrivers	1, 74, 108	Stadium Horn Buttons	94
Radsport Paint Brushes	3, 28	Sealing Compounds	90	Stadium Horns	47, 92
Radsport Pannier Bags	4, 7, 102	Seat Bolts	2, 72	Stadium Hydrometers	86
Radsport Plastic Handlebar Tape	5, 46	Seat Covers	103	Stadium Mirrors	60, 96
		Seat Pillars	43, 44, 72	Stadium Rear Lamps	57, 94
				Stadium Stoplight Switch	94
				Stands, Cycle	75, 107

W. G. CHEESE LIMITED
 CYCLE AND MOTOR ACCESSORIES, WIRELESS
 AND ELECTRICAL SUNDRIES

JUPITER HOUSE
 326-327, BRADFORD ST., BIRMINGHAM, 5
 Telephone: MIDland 5804/5 (2 lines)

CYCLE SECTION

COMPRISING . . .

- BAGS
- BELLS
- BRAKES
- CHAINS
- ENAMELS
- FORKS
- FRAMES
- GEARS
- LAMPS
- MUDGUARDS
- PEDALS
- PUMPS
- RIMS
- SADDLES
- TYRES
- WHEELS

W. G. CHEESE LIMITED
CYCLE AND MOTOR ACCESSORIES, WIRELESS
AND ELECTRICAL SUNDRIES

JUPITER HOUSE
326-327, BRADFORD ST., BIRMINGHAM, 5
Telephone: MIDland 5804/5 (2 lines)

"STOP PRESS"

NEW "RADSPORT" SPECIALITIES

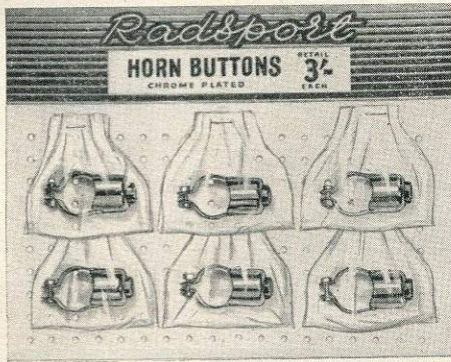

"RADSPORT" HORN BUTTONS
Superior chrome finish. 6 per card.
R6/1200 card each 3/-

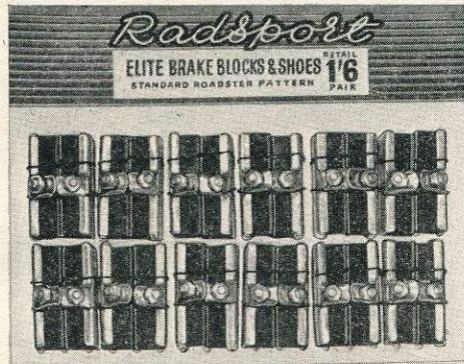

"RADSPORT" BRAKE BLOCKS AND SHOES
12 pairs per card. Finest quality.
Roadster Standard Pattern
Fitted Fibrax No. 3 Brake Blocks.
R1/1009 card per pair 1/6
Caliper Standard Pattern
Fitted with Fibrax No. 269 Brake Blocks.
R2/1009 card per pair 1/6
Raleigh Pattern Roadster
Fitted Fibrax No. 70 Brake Blocks.
R3/1009 card per pair 1/6
Raleigh Pattern Caliper
Fitted Fibrax No. 245 Brake Blocks.
R4/1009 card per pair 1/6
Juvenile Pattern
R5/800 card per pair 1/-

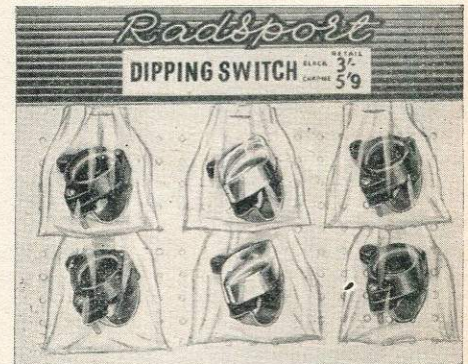

"RADSPORT" DIPPING SWITCHES
Precise action. Card contains 4 black and 2 chrome finish.
R10/1508 card Black each 3/-
Chrome each 5/9

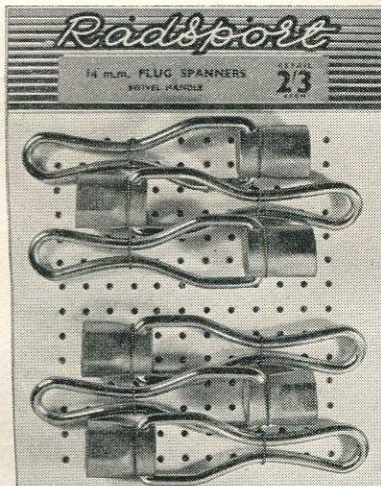

"RADSPORT" 14mm. PLUG SPANNERS
Clean, bright finish, with swivel handle.
6 per card.
R7/900 card each 2/3

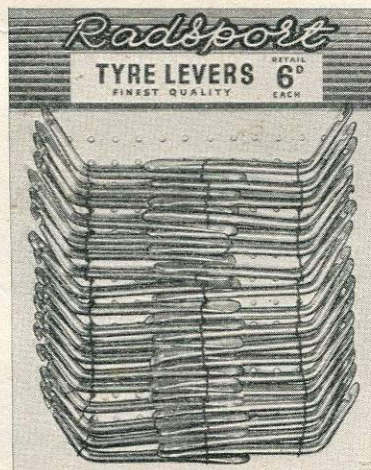

"RADSPORT" TYRE LEVERS
Finest quality. 36 per card.
R8/1009 card each 6d.



"RADSPORT" WOODEN HANDLED SCREWDRIVERS
12 per card.
R11/1800 card each 2/3

R 94

W. G. CHEESE LIMITED
CYCLE AND MOTOR ACCESSORIES, WIRELESS
AND ELECTRICAL SUNDRIES

JUPITER HOUSE
326-327, BRADFORD ST., BIRMINGHAM, 5
Telephone: MIDland 5804/5 (2 lines)

2 _____ "RADSPORT" BRANDED CYCLE SPECIALITIES

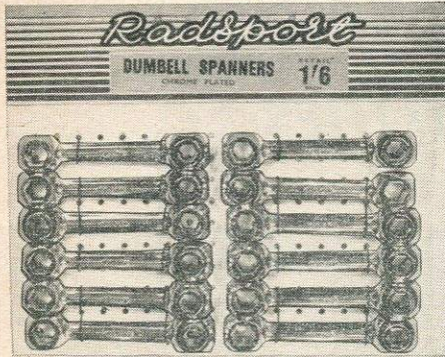

"RADSPORT" DUMBELL SPANNERS

12 per card.
R12/1200 card each 1/6

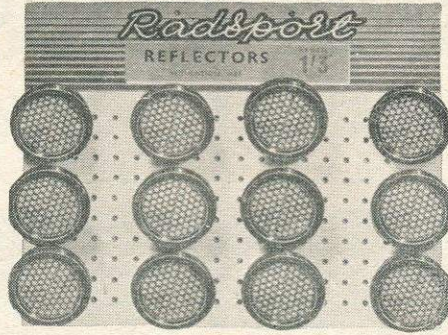

"RADSPORT" REFLECTORS

Rubber mounted. 12 per card.
R15/800 card each 1/3

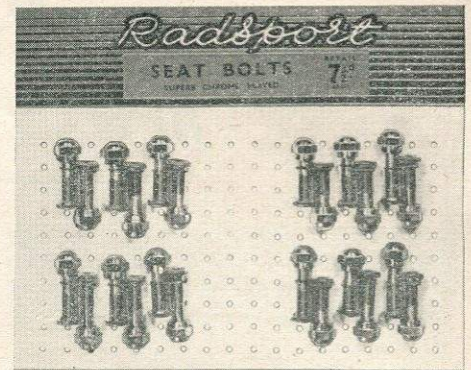

"RADSPORT" SEAT BOLTS

Superb design. 24 per card.
R18/1000 card each 7½d.

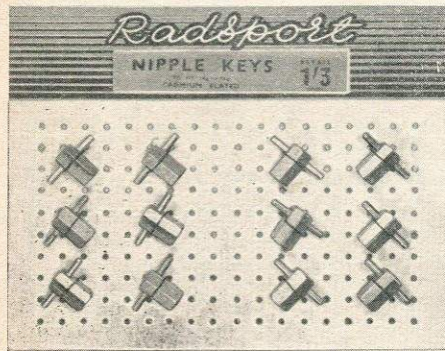

"RADSPORT" NIPPLE KEYS

12 per card.
R13/900 card each 1/3

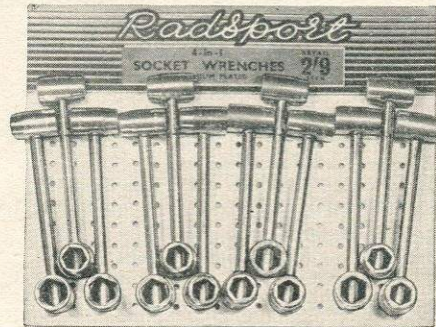

"RADSPORT" 4-IN-1 SOCKET WRENCHES

Chromium plated. 12 per card.
R16/2200 card each 2/9

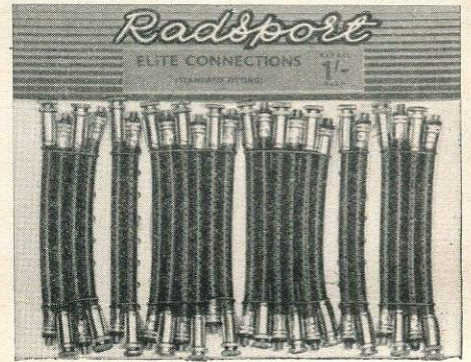

"RADSPORT" ELITE CONNECTIONS

Standard. 24 per card.
R19/1404 card each 1/-
H.P. 24 per card.
R20/1404 card each 1/-

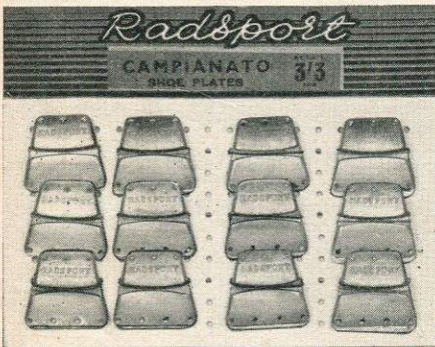

"RADSPORT" CAMPIANATO SHOE PLATES

12 pairs per card.
R14/2800 card per pair 3/6

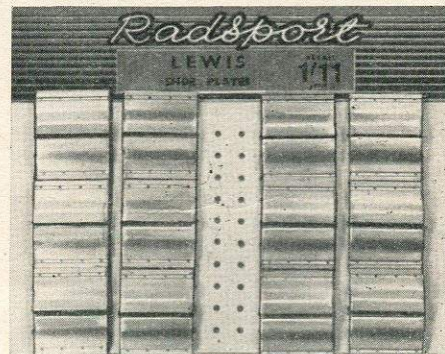

"RADSPORT" LEWIS SHOE PLATES

12 pairs per card.
R17/1504 card per pair 1/11

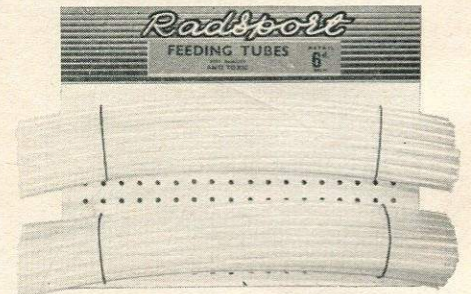

"RADSPORT" FEEDING TUBES

50 per card.
R21/1500 card each 6d.

Y-C-35

W. G. CHEESE LIMITED
CYCLE AND MOTOR ACCESSORIES, WIRELESS
AND ELECTRICAL SUNDRIES

JUPITER HOUSE
326-327, BRADFORD ST., BIRMINGHAM, 5
Telephone: MIDland 5804/5 (2 lines)

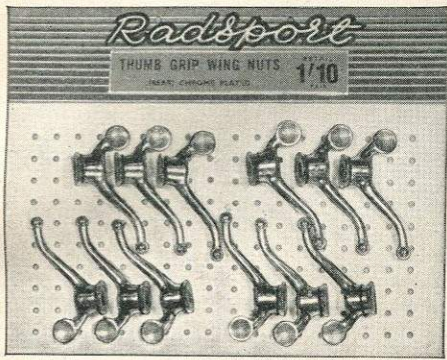

"RADSPORT" THUMB GRIP WING NUTS

Front. 12 per card.
 R22/704 card each 11d.
 Rear. 12 per card.
 R23/704 card each 11d.

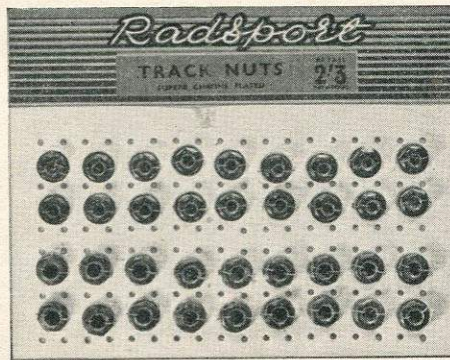

"RADSPORT" TRACK NUTS
 Finest quality

Front. 36 per card.
 R26/1306 card set of four 2/3
 Rear. 36 per card.
 R27/1306 card set of four 2/3
 Assorted. 36 per card.
 R28/1306 card set of four 2/3

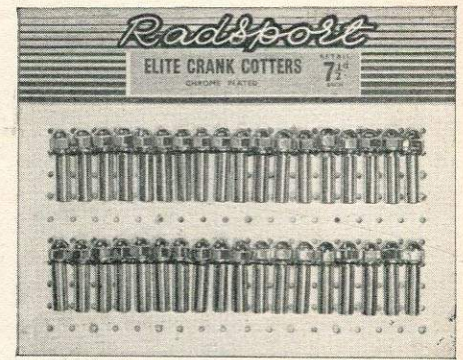

"RADSPORT" ELITE CRANKS CUTTERS

The best obtainable. 36 per card.
 R34/1306 card each 7 1/2d.
 Continental. 36 per card.
 R35/1306 card each 7 1/2d.

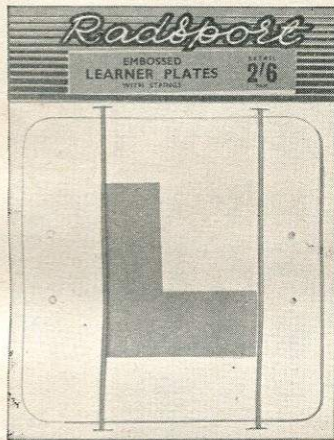

"RADSPORT" L PLATES

With strings. 12 pairs per card.
 R24/1800 card per pair 2/6



"RADSPORT" CELLULOID PUMPS

R30/210 9" White ... each 4/3
 R31/210 12" White ... each 4/3
 R32/3108 doz. 15" White ... each 3/11
 R33/3108 doz. 15" Black ... each 3/11

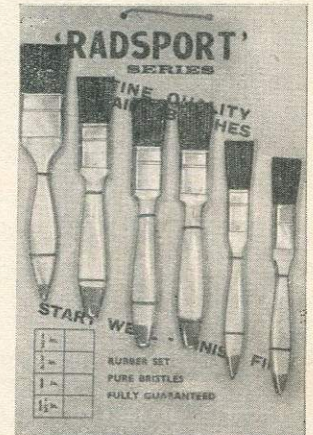

"RADSPORT" PAINT BRUSHES

1/2". 12 per card.
 R36/4200 card. 1302 each 1/6 1/8
 3/4", 1" and 1 1/2". 12 per card, assorted.
 R37/4706 card
 1906

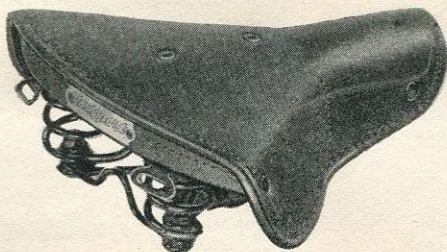

"RADSPORT" MATTRESS SADDLE

Black.
 R25/900 each 13/6

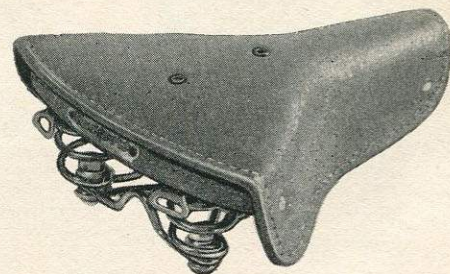

"RADSPORT" MATTRESS SADDLE

Tan with chrome undercarriage.
 R38/1000 each 15/-

Y-Q-22

W. G. CHEESE LIMITED
 CYCLE AND MOTOR ACCESSORIES, WIRELESS
 AND ELECTRICAL SUNDRIES

JUPITER HOUSE
 326-327, BRADFORD ST., BIRMINGHAM, 5
 Telephone: MIDland 5804/5 (2 lines)

4 "RADSPORT" BRANDED CYCLE SPECIALITIES

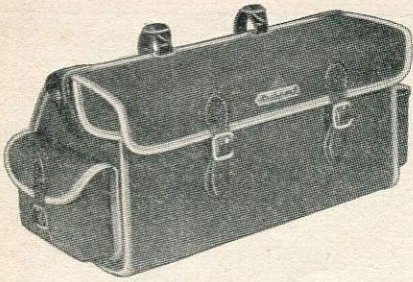

"RADSPORT" CYCLE BAG
 No. 222. Black. Rayon.
 R39/1008 each 16/-
 Plus Purchase Tax 2/7

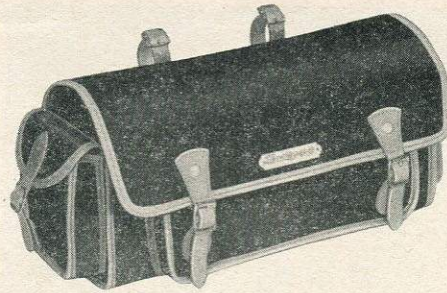

"RADSPORT" CYCLE BAG
 No. Y60/3P. 2 side pockets and 1 map pocket. Black. Rayon.
 R43/1108 each 17/6
 Plus Purchase Tax 2/10



"RADSPORT" CYCLE BAGS
 No. 33/2P. Tan. Fine quality. Stiffened.
 R45/1002 each 15/3
 Plus Purchase Tax 2/5

No. 33/2P. Black. Fine quality. Stiffened.
 R46/1002 each 15/3
 Plus Purchase Tax 2/5

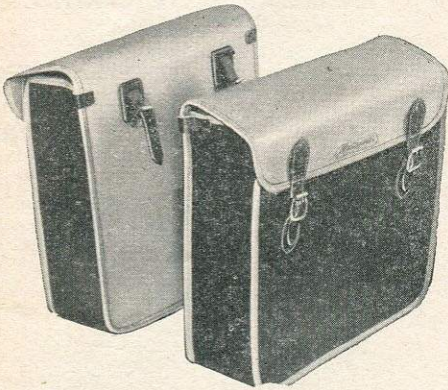

"RADSPORT" PANNIER BAGS
 Black. Rayon.
 R40/1908 per pair 29/6
 Plus Purchase Tax 4/9

Grey. Rayon.
 R41/1908 per pair 29/6
 Plus Purchase Tax 4/9

"RADSPORT" PANNIER BAGS
 No. 118.
 R42/2200 per pair 33/-
 Plus Purchase Tax 5/3



"RADSPORT" JACKET
 Superb styling. Size 34"/40". Black or Grey.
 R44/4106 each 54/6
 Plus Purchase Tax 2/-

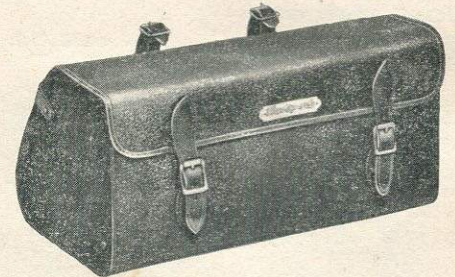

No. 33/NP. Tan. Fine quality. Stiffened.
 R47/800 each 12/-
 Plus Purchase Tax 1/11

No. 33/NP. Black. Fine quality. Stiffened.
 R47/800 each 12/-
 Plus Purchase Tax 1/11

No. Y63/2P. Black.
 R48/1800 (Not illustrated) each 27/-
 Plus Purchase Tax 4/4



"RADSPORT" MOPED PANNIER BAGS
 No. 118/9. Available in Red Stuart Tartan or Grey.
 R51/2200 per pair 33/-
 Plus Purchase Tax 5/3

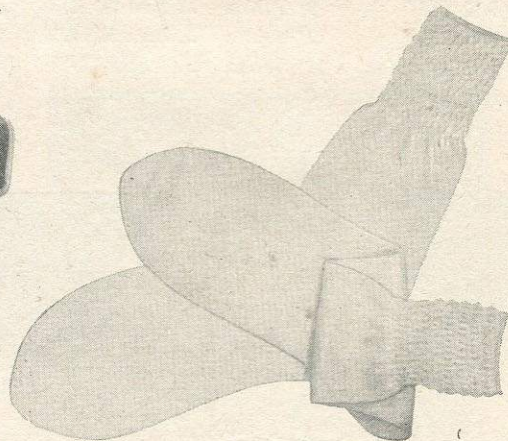

"RADSPORT" ANKLE SOCKS
 Sizes 9 to 11.
 R49/1800 doz. pairs per pair 2/3
 Plus Purchase Tax 1d. per pair

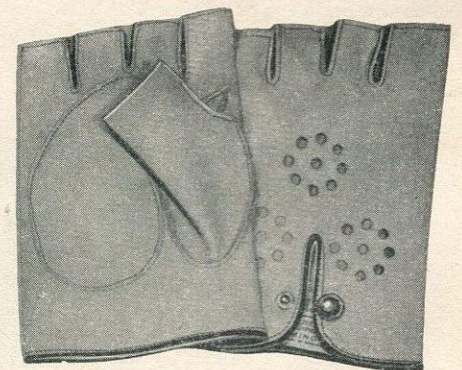

"RADSPORT" TRACK MITTS
 Sizes 8 to 10.
 R50/804 per pair 12/6
 Plus Purchase Tax 5d. per pair



The Finest Cape produced.
"RADSPORT" P.V.C. CAPE

45". Fabric based. Superb Gold. Lined collar. Lightning zip.
 R75/2111 each 32/10
 Plus Purchase Tax 1/1

"RADSPORT" P.V.C. SPATTEES
 R76/906 per pair 13/5
 Plus Purchase Tax 6d. per pair



"RADSPORT" FAWN OVERTROUSERS

R77/1108 per pair 16/8
 Plus Purchase Tax 7d. per pair

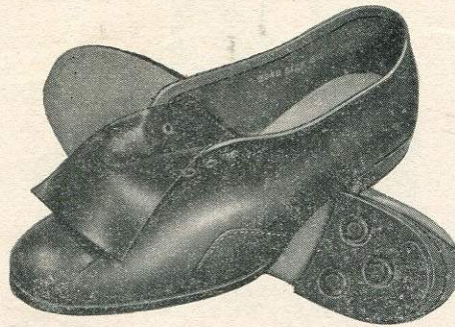

"RADSPORT" TOURING SHOES

Sizes 6 to 11. per pair 36/6
 R78/2706
 Plus Purchase Tax 1/3 per pair



"RADSPORT" ASPIRANT TRACK SHOES

Sizes 5 to 11. per pair 35/6
 R79/2606
 Plus Purchase Tax 1/3 per pair

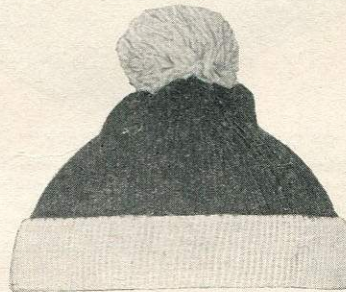

"RADSPORT" WOOLLEN BOBBY CAP

In two-tone colours. each 5/7
 R80/309
 Plus Purchase Tax 2d.



"RADSPORT" FAWN CAPE

Super quality.
 42".
 R81/1606 each 23/10
 Plus Purchase Tax 8d.

45".
 R82/1706 each 24/3
 Plus Purchase Tax 9½d.

"RADSPORT" FAWN LEGGINGS
 R83/1403 per pair 19/4
 Plus Purchase Tax 7d. per pair



"RADSPORT" EMBOSSED PLASTIC HANDLEBAR TAPE

Opaque. Red, White, Black, Yellow, Green, Blue, Ice Blue.
 Transparent. Red, Blue, Green.

R84/804 50-yd. rolls ... each 12/6
 R85/08 3-yd. rolls ... each 1/-

"RADSPORT" EMBOSSED PLASTIC P.V.C. TAPE

Red, White, Black, Yellow, Green, Blue, Ice Blue.

R86/100 5-yd. rolls ... each 1/6

Y G 2

W. G. CHEESE LIMITED
 CYCLE AND MOTOR ACCESSORIES, WIRELESS
 AND ELECTRICAL SUNDRIES

JUPITER HOUSE
 326-327, BRADFORD ST., BIRMINGHAM, 5
 Telephone: MIDland 5804/5 (2 lines)

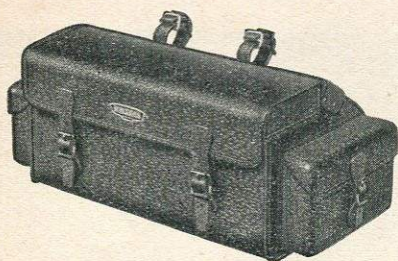
**BROOKS "GLENBROOK"**

With "D" loops for cape straps.
Size: 13" x 7" x 6½".

B5/1102 each 16/9
Plus Purchase Tax 2/9

**BROOKS "ROYALBROOK"**

In extra hard wearing stiffened material with stout leather wearing patches. Fitted with Quick Release Rod and built-in steel suspension bar. Cape straps and all other straps made in the finest leather.

Size: 13" x 8" x 9½".
B10/3303 each 49/11
Plus Purchase Tax 8/1

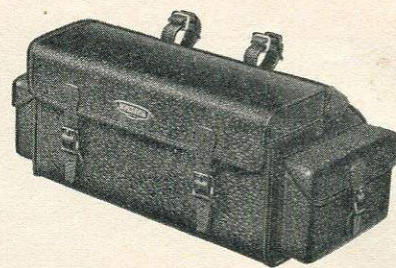
**BROOKS "LEALBROOK"**

Made in high-grade stiffened black-grained material, with solid leather straps. Feature the Brooks pocketed suspension bar and P.V.C. shield.

Size: 13" x 7" x 6½".
B17/1407 each 21/11
Plus Purchase Tax 3/7

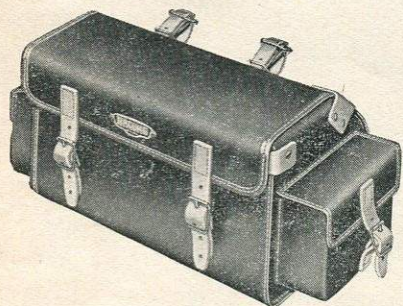
**BROOKS "SOUTHBROOK"**

B6/1407 each 21/11
Plus Purchase Tax 3/7

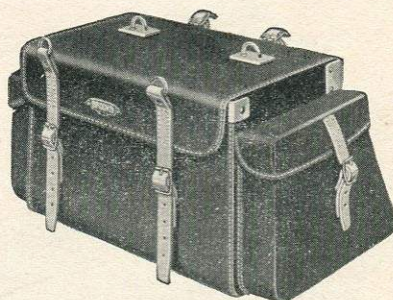
**BROOKS "HIGHBROOK"**

B12/2401 each 36/1
Plus Purchase Tax 5/11

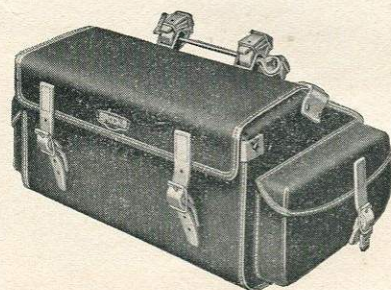
**BROOKS "HALESBROOK"**

B19/1906 each 29/3
Plus Purchase Tax 4/9

**BROOKS "MILLBROOK"**

Designed with a wide opening to permit easy access. Fitted with the Brooks pocketed suspension bar and P.V.C. shield to ensure hard wear.

Size: 9" x 7" x 6½".
B7/607 each 9/11
Plus Purchase Tax 1/7

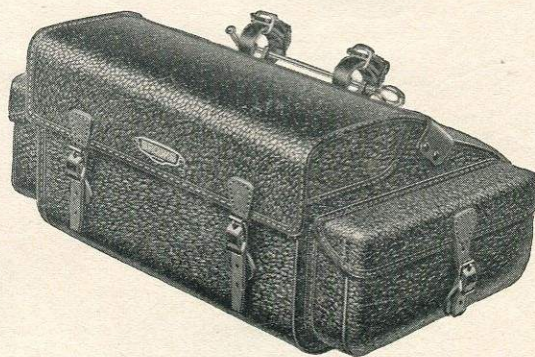
**BROOKS "MOSSBROOK"**

A stiffened bag with two end pockets, fitted with the Brooks Quick Release Rod and "D" loops for cape straps. The P.V.C. shield and wearing patch offer protection to the body, and hooded lid is proof against bad weather. Solid leather straps.

Size: 13" x 8" x 9½".
B14/1906 each 29/3
Plus Purchase Tax 4/9

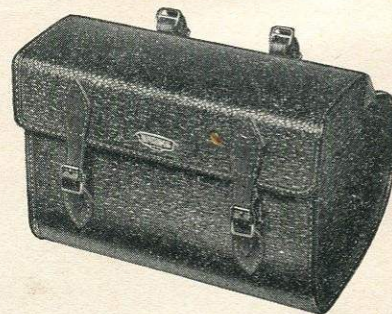
**BROOKS "FLEETBROOK"**

An ideal all-purpose bag with interior elasticated pockets, and "D" loops for cape straps. Brooks pocketed suspension bar and P.V.C. shield.

Size: 11" x 8" x 9¾".
B20/1204 each 18/6
Plus Purchase Tax 3/-

BROOKS "LYNBROOK"

B8/702 each 10/9
Plus Purchase Tax 1/9

BROOKS PANNIERS

No. B2085. Suitable for Moped or Cycle.
B15/1407 each 21/11
Plus Purchase Tax 3/7

BROOKS "WESTBROOK"

B22/1306 each 20/3
Plus Purchase Tax 3/3

A-7-7

W. G. CHEESE LIMITED
CYCLE AND MOTOR ACCESSORIES, WIRELESS
AND ELECTRICAL SUNDRIES

JUPITER HOUSE
326-327, BRADFORD ST., BIRMINGHAM, 5
Telephone: MIDland 5804/5 (2 lines)

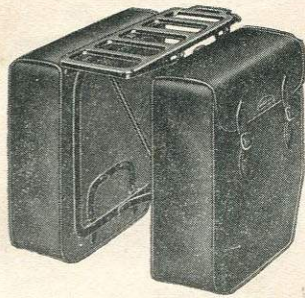

MIDLAND "MODEL" PANNIER SET

No. 4593. Consists of two bags (12" x 12" x 4") fitted with rigid metal frames designed for easy attachment to Steel Carrier supplied. A suitable type is available with clip (all tube) fittings or for spindle (26" or 28" wheel) fitting. The Carrier is finished in Black enamel.

B50/3408 per set 52/-
Plus Purchase Tax 3/4



HOFFMANN STEEL BALLS

		B61/Trade	
Dia.		Per 100	Per 1,000
1/8"	1/4	11/8
5/32"	1/10	16/8
3/16"	2/8	24/2
7/32"	3/6	31/8
1/4"	4/3	38/4
5/16"	8/3	75/-

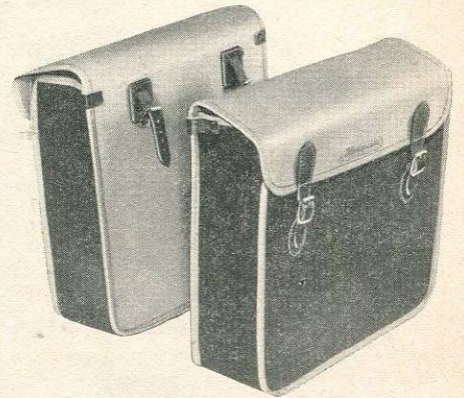

"RADSPORT" PANNIER BAGS

Black Rayon.

B69/1908 per pair 29/6
Plus Purchase Tax 4/9

Grey Rayon.

B70/1908 per pair 29/6
Plus Purchase Tax 4/9

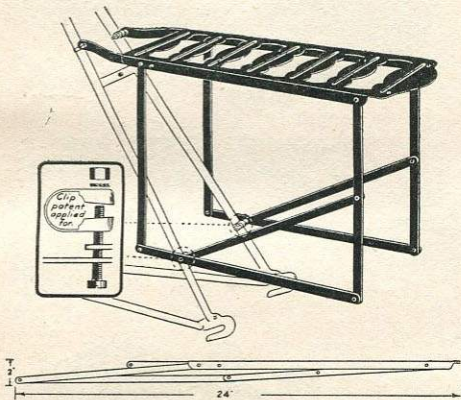

BAYCLIFF PANNIER CARRIERS

Suitable for all Pannier Sets. Adjustable fittings to clear caliper brakes. Rigid and horizontal when fitted. Black enamelled steel.

B52/1006 each 15/9

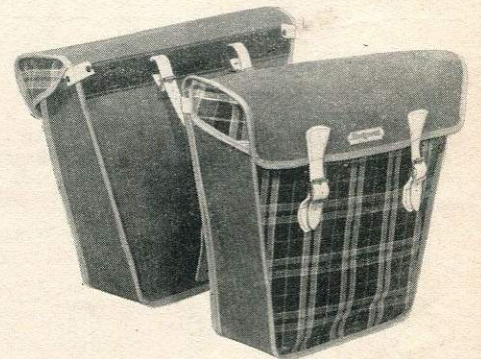

"RADSPORT" MOPED PANNIER BAGS

No. 118/9. Available in Red Stuart Tartan or Grey.

B71/2200 per pair 33/-
Plus Purchase Tax 5/3



B.M.B. BALLPAKS

Showcard holding 20 packets of 1/8", 5/32", 3/16", 7/32" or 1/4" Steel Balls in cellophane envelopes.

B54/1507/card per packet 1/2

CYKEWEAR SHOULDER BAGS

Size: 15" high and 8" diameter. In plaid, red/black or red/grey, and with shoulder carrying rope through eyelets.

B68/604 each 9/6
Plus Purchase Tax 1/6

"MARTY" SHOULDER BAGS

Size: 15" high and 8" dia. A gay modern bag with Rock and Roll motifs on White background.

B62/504 each 8/-
Plus Purchase Tax 1/3

W. G. CHEESE LIMITED
CYCLE AND MOTOR ACCESSORIES, WIRELESS
AND ELECTRICAL SUNDRIES

JUPITER HOUSE
326-327, BRADFORD ST., BIRMINGHAM, 5
Telephone: MIDland 5804/5 (2 lines)

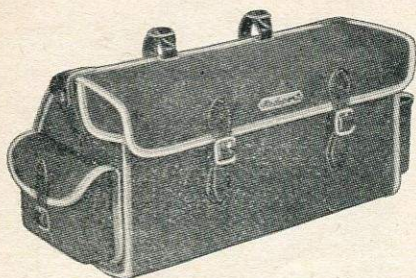
**"RADSPORT" CYCLE BAG**

No. 222. Black.

B79/1008 each 16/-

Plus Purchase Tax 2/7

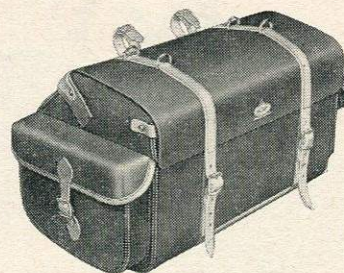
**BAYCLIFF "STRONG PACK"**

A heavy duty Touring Bag, made from Black Duck. Heavy matching leather parts with reinforced corners. Wearing piece attached to rear and bottom eliminates chafing of saddle springs and mudguard top. With two end pockets.

Size: 13" x 9" x 8½".

B84/2310 each 35/9

Plus Purchase Tax 5/9

**MIDLAND TOURING BAG**

No. 654. No pockets. Size 9" x 7" x 5" to 3". Tan.

B98/406 each 6/9

Plus Purchase Tax 1/1

CLEMENT "MUSSETTE" BAGS

In assorted colours. Made in Italy.

B99/108 each 2/6

Plus Purchase Tax 5d.

BAYCLIFF "SOLO" PANNIER BAGS

Constructed from good quality leather cloth. Substantial clips and robust straps with fibre stiffener at back. With one end pocket on each bag. Size, 12" x 11" x 4½".

B77/2502 each 37/9

Plus Purchase Tax 6/1

**"RADSPORT" CYCLE BAGS**

No. 33/2P. Black or Tan.

S91/1002 each 15/3

Plus Purchase Tax 2/5

No. 33/NP. Tan.

S92/800 each 12/-

Plus Purchase Tax 1/11

No. 33/NP. Black.

S93/800 each 12/-

Plus Purchase Tax 1/11

No. Y63/2P. Black.

S94/1800 (not illustrated) ... each 27/-

Plus Purchase Tax 4/4

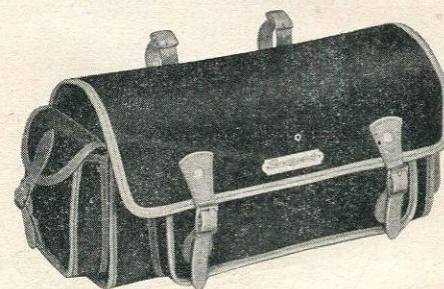
**"RADSPORT" CYCLE BAG**

No. Y60/3P. 2 side pockets and 1 map pocket. Black. Rayon.

B100/1108 each 17/6

Plus Purchase Tax 2/9

**DUAL-PURPOSE BASKETS**

Fitted with two straps and stout handles for use as shopping/handlebar baskets.

B80/1200 Large Size each 18/-

B81/608 Small Size each 10/-

B82/800 Medium Size each 12/-

B83/404 Juvenile each 6/-

Exempt from Purchase Tax

CYKEWEAR TOURING BAGS

No. Y62NP. Size 9" x 7" x 7". Made in Black or tan rayon with beige edges.

B101/608 each 10/-

Plus Purchase Tax 1/7

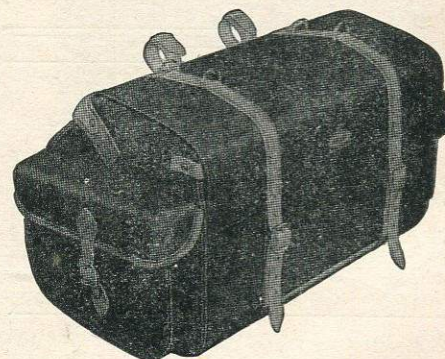
**BAYCLIFF "ROUGH RIDER"**

A large edition of the "Strong Pack". Size: 15" x 9" x 9½".

B87/2704 each 41/-

Plus Purchase Tax 6/7

Y C 2

W. G. CHEESE LIMITED
CYCLE AND MOTOR ACCESSORIES, WIRELESS
AND ELECTRICAL SUNDRIES

JUPITER HOUSE
326-327, BRADFORD ST., BIRMINGHAM, 5
Telephone: MIDland 5804/5 (2 lines)

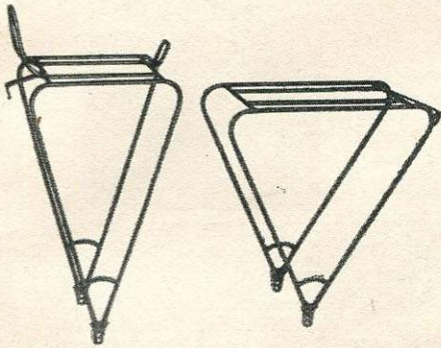

CONTINENTAL CARRIERS

B199/1108 Front each 17/6
 B200/900 Rear each 13/6

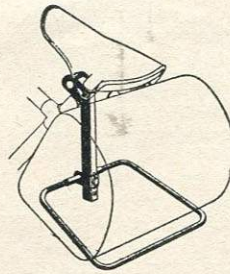

LLOYD'S "HIGHWAY" LUXURY BAG SUPPORT

No. 25. Silver-grey enamelled.
 B202/702 each 10/9

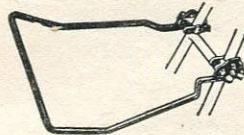

LLOYD'S "HYLO" ADJUSTABLE TOURING BAG SUPPORT

No. 24. Any height or angle can be obtained by a simple movement of the cantilever brackets constructed from special quality steel wire. Chrome plated.
 B190/411 each 7/4

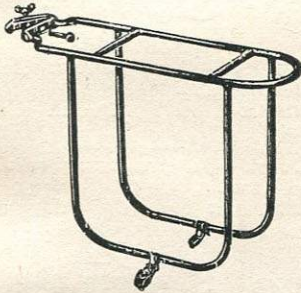

LLOYD'S "KARRI-MASTER" PANNIER BAG HOLDER

Platform size: 16" x 5".
 No. 31. Polished alloy.
 B183/1308 each 20/6

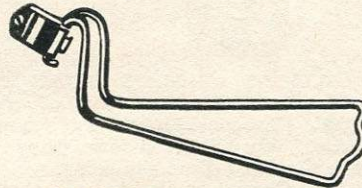

ASHBY BAG SUPPORT

No. 48. Very light single clip fitting, for attachment to seat pillar. Weight, 4 3/8 ozs. Enamelled black.
 B196/1704 doz. each 2/2

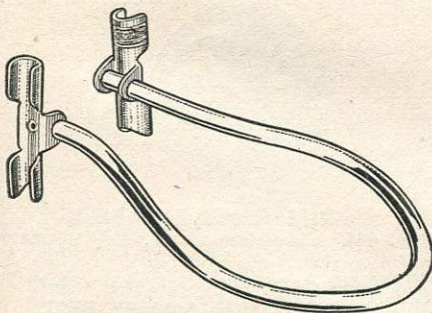

LLOYD'S QUICKFIT BAG SUPPORTS

Instantly attached or detached. Alloy or steel. 1/2" or 3/8" clip fitting.
 B184/405 Alloy, polished ... each 6/7
 B185/309 Steel, black enamelled each 5/7

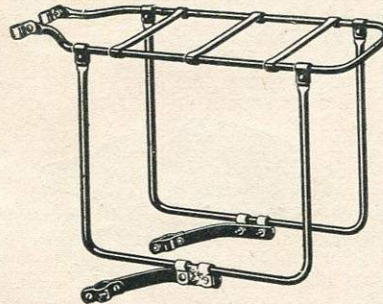

ASHBY PANNIER CARRIER

No. 45. A tubular carrier designed for avoiding side "whip". Construction, light steel tubing.
 B192/808 Black finish ... each 13/-
 B193/900 Silver finish ... each 13/6

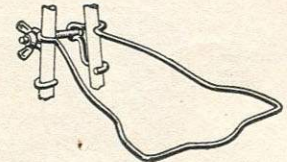

ASHBY BAG SUPPORT

No. 50. Universal fitting. Chromium plated.
 B195/304 each 5/-3

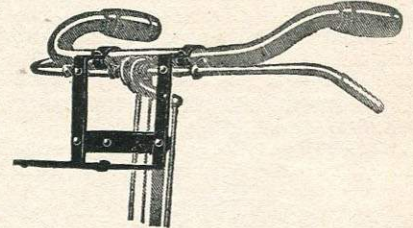

SMITH'S "HOLDON" HANDLEBAR BASKET SUPPORT

No. 55. Enables one to carry twice the weight. Note.—The extra strength it gives to the basket.
 B201/200 each 3/-

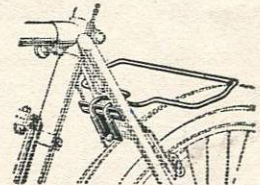

SMITH'S BAG SUPPORT

No. 80. Chromium plated.
 B197/208 each 4/-

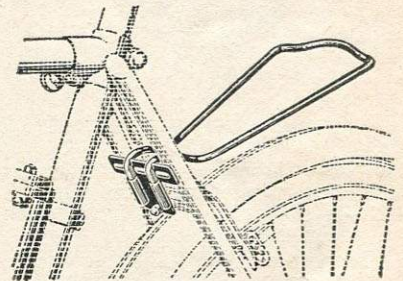

SMITH'S BAG SUPPORT

No. 90. Attaches to brake pivot bolt.
 B180/200 each 3/-

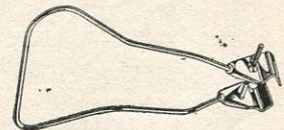

BROOKS BAG SUPPORT

No. B2166. A patent fitment which clips on to the rear stays of bicycle and clamped in position by winged nut and screw.
 B188/310 Chrome ... each 5/9
 B189/208 Silver ... each 3/11

Y G I

W. G. CHEESE LIMITED
 CYCLE AND MOTOR ACCESSORIES, WIRELESS
 AND ELECTRICAL SUNDRIES

JUPITER HOUSE
 326-327, BRADFORD ST., BIRMINGHAM, 5
 Telephone: MIDland 5804/5 (2 lines)

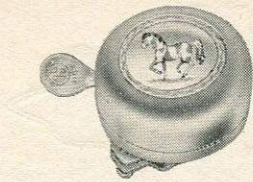

ADIE "CHILDREN'S" BELL

No. 747. With picture tops. Chromium-plated finish to dome. Stove enamelled base and universal clip for $\frac{1}{2}$ "- $\frac{7}{8}$ " bar. Dome $1\frac{3}{8}$ " dia. fitted decorative emblems in six assorted designs.

B210/2200 doz. ... each 2/9

ADIE "JUVENILE" BELL

No. 848. Dome 2" dia.
B211/1800 doz. Chromium plated each 2/3
B212/1704 doz. Assorted colours each 2/2

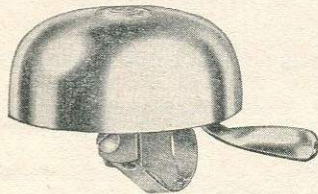

ADIE "MASTER" BELL

No. 343. Challis type. Dome, 3" diameter. Fitted with medallion, band clip. Chromium plated.

B214/3600 doz. ... each 4/6

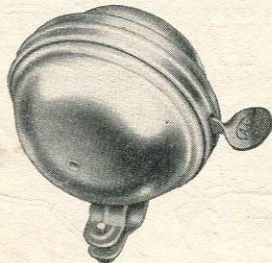

ADIE "DOUBLE DOME" BELL

No. 242. Chromium plated (revolving type) $2\frac{1}{2}$ " diameter domes, two-screw clip.

B216/404 ea. ... each 6/6

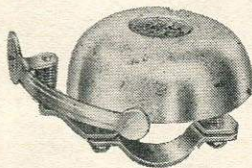

ADIE "CLUB" BELL

No. 545. The "Club" Lightweight sports bell. 2" alloy dome with cyclist medallion. Dome in Red, Blue, Green or Gold lustre finish and also available in polished alloy. Packed one dozen in carton in finish as ordered. Clip for $\frac{7}{8}$ "- $1\frac{1}{8}$ " bars.

B218/1800 doz. Polished alloy each 2/3

B219/2000 doz. Coloured finish each 2/6

ADIE "QUALITY" BELL

No. 646. Two-screw clip. Dome $2\frac{3}{8}$ " diameter, fitted with medallion. Chromium plated.

B220/2600 doz. ... each 3/3

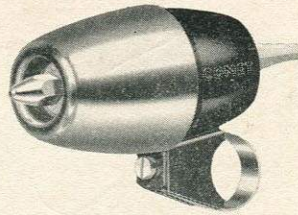

LUCAS COMET BELL

No. 75. With chromium-plated dome, red plastic centre and trigger lever.

B222/404 ... each 6/6

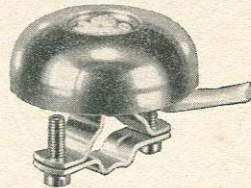

LUCAS "LION" BELL

No. 7. Assorted colours.
B224/106 ... each 2/3

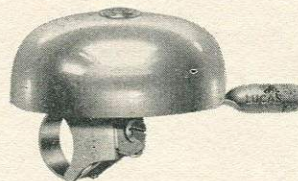

LUCAS CHALLIS BELLS

No. 30. 3" steel dome. Band clip fixing.
B226/302 Chromium plated ... each 4/9

No. 50. 3" brass bell metal dome giving a loud and effective ring. Band clip fixing.

B227/404 Chromium plated ... each 6/6

LUCAS BELLS

No. 3. $2\frac{3}{8}$ " brass dome, giving a penetrating ring. Band clip fixing.

B228/210 Chromium plated ... each 4/3

No. 61. Brass bell metal dome. Band clip fixing.

B229/500 Chromium plated ... each 7/6

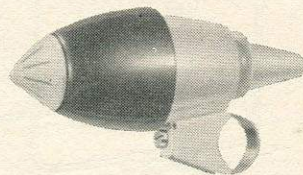

No. 85 LUCAS METEOR BELL

No. 85. Space age styling for the younger generation. A new look in bells designed to catch the eye of youth. Colours to suit modern machines—Sapphire, Ruby or Chromium Plated with Ivory White nose cone and base.

B230/500 ... each 7/6

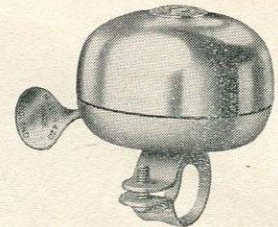

MILLER BELL

No. 420. Rotary type striker. $2\frac{3}{8}$ " dome. Fitted with screw-type clip. Chromium plated.

B238/202 ... each 3/3

MILLER BELL

No. 520. Rotary type, $2\frac{3}{8}$ " bell metal brass dome and non-slip band clip. Chromium plated.

B240/206 ... each 3/9

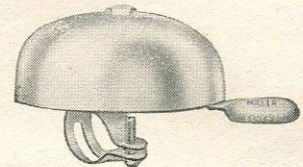

MILLER BELL

No. 720. 3" dome. Side-to-side action. Chromium plated.

B242/300 ... each 4/6

MECA BELLS

$2\frac{3}{8}$ " Dome. A consistently reliable bell. Chrome Plated.

B243/2000 doz. ... each 2/6

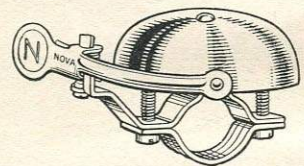

FLUK NOVA BELLS

Alloy, with external mechanism.

B244/104 Polished ... each 1/11

Anodised. Colours: Red, Blue, Green or Gold.

B245/1806 doz. ... each 2/3

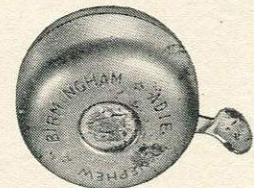

ADIE "EMBLEM" BELL

No. 444. Chromium plated. $2\frac{3}{8}$ " diameter. With emblem medallion.

B247/2000 doz. ... each 2/6

ADIE "OWN NAME" BELL

No. 444/DN. The modified "Emblem" Bell, chromium plated, stamped with Dealer's name and town or advertising slogan, up to a maximum of 29 letters, stops and spaces between words or initials. Lettering filled-in in red with blue medallions.

B249/Trade 6 dozen lots per doz. 27/6

B250/Trade 12 dozen lots per doz. 25/-

Y-D-22

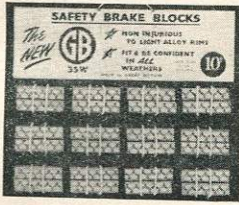

G.B. BRAKE BLOCKS

No. 35W. Brake block "Wetgrip" patterned. 12 pairs on showcard.

B280/608 card per pair 10d

G.B. BRAKE BLOCKS AND SHOES

No. 36P. Brake blocks with "Wetgrip" patterned blocks. 12 pairs on showcard.

B281/1504 card per pair 1/11

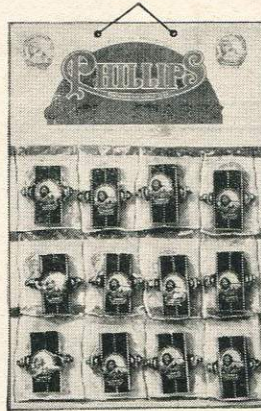

PHILLIPS CARDED BRAKE SHOES AND RUBBERS

12 pairs per card.

No. B201X. For Standard and Juvenile Brakes.

B298/Trade per card ~~8/7~~ 9/11

No. C201X. For Vox Populi, Grand Vitesse Front.

B299/Trade per card ~~41/9~~ 42/8

No. C209X. For Vox Populi, Grand Vitesse Rear.

B300/Trade per card ~~15/4~~ 16/5

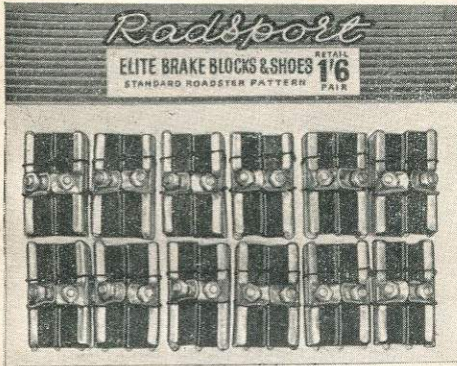

"RADSPORT" BRAKE BLOCKS AND SHOES

12 pairs per card. Finest quality.

Roadster Standard Pattern

Fitted with Fibrax 3 Brake Blocks.

B286/1009 card per pair 1/6

Caliper Standard Pattern

Fitted with Fibrax 269 Brake Blocks.

B287/1009 card per pair 1/6

Raleigh Pattern Roadster

Fitted with Fibrax 70 Brake Blocks.

B288/1009 card per pair 1/6

Raleigh Pattern Caliper

Fitted with Fibrax 245 Brake Blocks.

B289/1009 card per pair 1/6

Juvenile Pattern

B290/800 card per pair 1/-

WEINMANN BRAKE BLOCKS

Studded brake blocks on cards, 12 pairs, 1 3/8" Red.

B315/608 card per pair 10d.

WEINMANN BRAKE BLOCKS AND SHOES

B316/1500 card (10 pairs) per pair 2/3

BRAKE SHOES RELINED

B294/Trade Solo each 5/6

B295/Trade Tandem each 6/8

ALBION JUVENILE BRAKE BLOCKS

No. 1942J. Card of 12 pairs.

B306/Trade per card 2/-

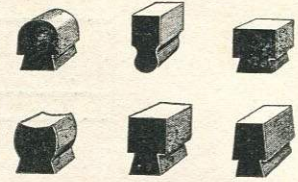

JOHN BULL CYCLE BRAKE BLOCKS

- No. 2. Flat narrow shoe.
 - No. 4. For Raleigh.
 - No. 6. Standard square.
 - No. 10. Taper top, for standard shoe.
 - No. 15. For Hercules.
 - No. 16a. Medium Endrick. 1 7/8" long.
 - No. 19. For Raleigh caliper, Hercules caliper and Royal Enfield racing models.
 - No. 25. Caliper for Hercules, Phillips and Brooks, 1 3/4" long.
 - No. 26. For Webb caliper.
- B318/504 per pair 8d.

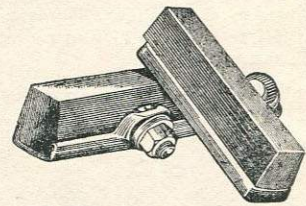

JOHN BULL BRAKE BLOCKS IN SHOES

B320/1400 per pair 1/9



JOHN BULL CABLE CLIPS

- Coloured: Green or Red. Standard pattern. Carded in 2 dozens.
- B322/504 card each 4d.
- Black.
- B323/400 card each 3d.



DUNLOP BRAKE CABLE CLIPS

- No. CC/1. Black rubber. 36 on card.
- B325/200 doz. (Or asstd.) per doz. 3/-
- No. CC/2. Assorted (9 each, Blue, Red, Cream, Green).
- B326/208 doz. per doz. 4/-

B 263

W. G. CHEESE LIMITED
CYCLE AND MOTOR ACCESSORIES, WIRELESS
AND ELECTRICAL SUNDRIES

JUPITER HOUSE
326-327, BRADFORD ST., BIRMINGHAM, 5
Telephone: MIDland 5804/5 (2 lines)



FERODO BRAKE BLOCKS B264/K

Type	Pattern No.	Per Pair
Flat Top for stirrup brakes, Bowden, Brampton, Buckley, Crabbe. Wide pattern	51A	8d.
Bowden Tyseley Tapered pattern, Buckley Stirrup, Hercules tapered ...	52	8d.
Humber, Raleigh Stirrup Brakes	57A	8d.
B.S.A. heavy pattern, Bowden Stirrup heavy pattern, Hercules Stirrup and Caliper, Phillips Selwell standard, Celtonia, Vox Populi	92A	8d.
Macmillan Caliper, Phillips Philco Caliper	92B	8d.
Enfield Caliper, Humber Caliper, Raleigh Caliper	98B	8d.
Monitor Climax, Monitor Super Cam.	106	8d.
Burlite Caliper, GB Caliper, Monitor Caliper, Phillips Philco Caliper, Phillips Philite Caliper, Phillips Selwell Caliper (Endrick), Phillips Vox Populi Caliper	109	8d.
Webb Caliper	110	8d.

FIBRAX CYCLE BRAKE BLOCKS B268/K

Pattern No.	Per Pair	No.	Machine	Per Pair
3			Flat Top for Stirrup Brakes, Brampton and Crabbe (Wide) Buckley, James, Saxon, Evans Stirrup ...	8d.
70			Raleigh 1919 on, Humber 1931 on, Stirrup Brakes ...	8d.
144			New Hudson, Hercules (Large Square) Cycles, Phillips Carrier Brakes and Stirrup Brakes on Motorised Cycles	11d.
245			Raleigh, Enfield 1933 on, Humber 1931 on, Caliper ...	8d.
250			Endrick Rim, Shallow Block ...	8d.
251			Resilion Cantilever, Front, $\frac{1}{4}$ " deep, 3" long, Model A ...	10d.
253			Resilion Cantilever, Tandem Front and Rear, $\frac{7}{16}$ " deep, 3" long, Model A ...	10d.
253 x 2 1/4			Resilion Cantilette, Front and Rear, $\frac{7}{16}$ " deep, 2 1/4" long, Model B ...	8d.
254			Narrow Crabbe (Wide Top), Hercules Stirrup and Caliper	8d.
258			Phillips Selwell, Standard, Celtonia, Crabbe, Vox Populi, B.S.A., Stirrup ...	8d.
260			Resilion Cantilever, Front and Rear, $\frac{5}{16}$ " deep, 3" long, Model A ...	10d.
269			G.B., Phillips Selwell, Philco and Strata Caliper Brakes...	8d.
282			G.B. Coureur & Grand Tour	8d.
284			Studded for G.B. Coureur & Grand Tour ...	10d.
285			Studded for G.B. Standard, 1 3/4" long ...	10d.

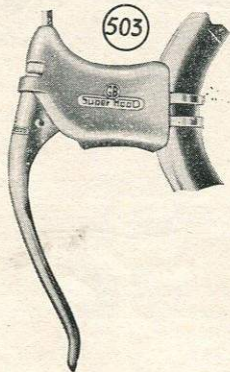

G.B. BRAKE HOOD RUBBERS

No. 503. Superhood rubbers for Coureur Plus, Superhood and Superhood Rapid levers.
B260/300 per pair 4/6
 No. 508. Rapide half rubbers for Superhood Rapide and Superhood Plus levers.
B270/300 per pair 4/6

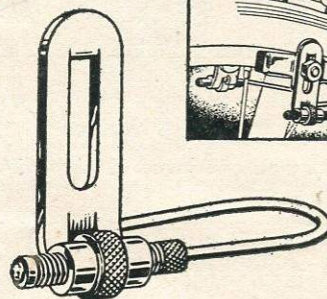
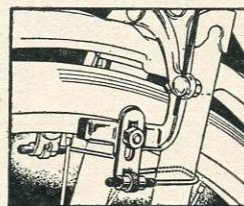

WEBB BRAKE ANCHORS

Fits all makes of caliper brakes.

271/206 per pair 3/9



WESTFIELD RUBBER BRAKE-LEVER HOODS

Colour range: Red, Green, Blue, White, Yellow and Black.
272/202 each 3/3

DAWES PLASTIC BRAKE LEVER SLEEVES

B274/102 per pair 1/9

A 938

W. G. CHEESE LIMITED
 CYCLE AND MOTOR ACCESSORIES, WIRELESS
 AND ELECTRICAL SUNDRIES

JUPITER HOUSE
 326-327, BRADFORD ST., BIRMINGHAM, 5
 Telephone: MIDland 5804/5 (2 lines)

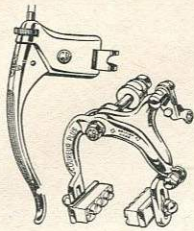

G.B. CABLE BRAKES

Coureur "Plus". Supplied in A or B depth stirrups. Fitted with Superhood Plus lever with nylon bushes.

B375/2800 per pair 42/-

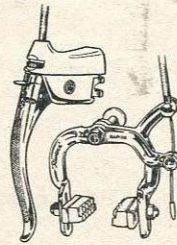

G.B. CABLE BRAKES

"Riviera Rapide". Fitted with Superhood lever and complete with nylon bushes.

B386/2800 per pair 42/-

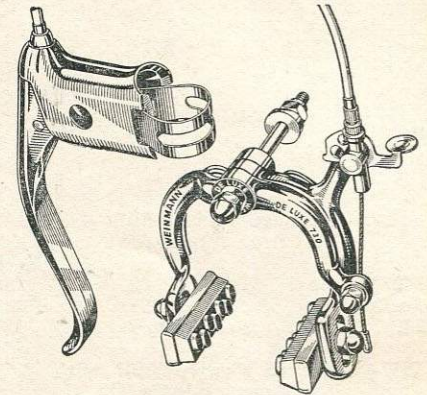

WEINMANN LIGHTWEIGHT CABLE BRAKES

No. 730. Front Brake with Quick Release.
B393/1310 each 20/9

No. 730. Rear Brake with Quick Release.
B394/1400 each 21/-

No. 500. Front Brake with Quick Release: Shallow stirrups.
B395/1400 each 21/-

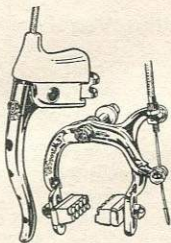

G.B. CABLE BRAKES

"Sports Mk. III". Fitted with "Arret" lever. Designed to give maximum braking efficiency.

B377/2504 per pair 38/-

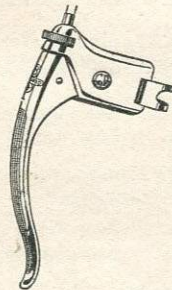

G.B. "SUPERHOOD" LEVER

No. 585. Chromium-plated finish.
B389/608 complete 10/-

G.B. "GRAND TOUR" LEVER

No. 575. Chromium-plated finish.
B390/500 complete 7/6

WEINMANN IMPROVED COLOURED BRAKES

Coloured Anodised Brakes in Silver, Blue and Red. Comprises Front and Rear Brakes and Lever.

B396/3000 each 45/-

WEINMANN VAINQUER BRAKES Q.R.

No. 999. Centre pull compensating action all nylon bearings for smooth action and long life.

B398/4008 per pair 61/-



G.B. BOXED BRAKES SPARES KIT

Strong wood construction. Make-up of kit enables the servicing of any G.B. brake or handlebar stem.

B385/Trade each 120/-

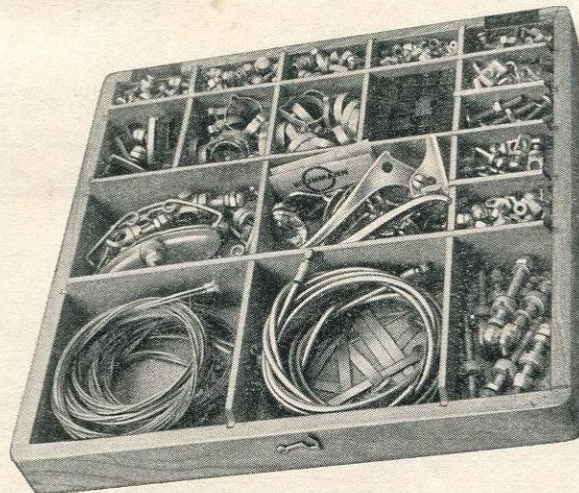

WEINMANN SPARES KIT

Spare Parts in wooden display cabinet with assorted popular components.
B392/Trade complete £6 0 0

X 3 16

W. G. CHEESE LIMITED
CYCLE AND MOTOR ACCESSORIES, WIRELESS
AND ELECTRICAL SUNDRIES

JUPITER HOUSE
326-327, BRADFORD ST., BIRMINGHAM, 5
Telephone: MIDland 5804/5 (2 lines)

CLARKS "SUPPLEFLEX" CALIPER BRAKE TRANSMISSIONS

(T-Nipple) Black or silver

5010—Standard Centre Pull—Philco Pear Nipples

		Each
B340/1400 doz.	Front ...	1/9
B340/1803 doz.	Rear, Gents' ...	2/3
B340/2008 doz.	Rear, Ladies' ...	2/7

5017—Standard Centre Pull with $\frac{9}{32}$ " Barrel Nipple

B341/1400 doz.	Front ...	1/9
B341/1803 doz.	Rear, Gents' ...	2/3
B341/2008 doz.	Rear, Ladies' ...	2/7

5011—Standard Side Pull (Pear)

B342/1610 doz.	Front ...	2/1
B342/2006 doz.	Rear, Gents' ...	2/7
B342/2308 doz.	Rear, Ladies' ...	2/11

5012—Standard Side Pull with $\frac{9}{32}$ " Barrel Nipple

B343/1610 doz.	Front ...	2/1
B343/2006 doz.	Rear, Gents' ...	2/7
B343/2308 doz.	Rear, Ladies' ...	2/11

5014—Raleigh Pattern

B344/1610 doz.	Front ...	2/1
B344/2006 doz.	Rear, Gents' ...	2/7
B344/2211 doz.	Rear, Ladies' ...	2/10

CLARK'S WATERPROOF HUB BRAKE TRANSMISSIONS

5018—Sturmey-Archer (Old Type) Pattern

		Each
B358/111	Front ...	3/-
B358/206	Rear, Gents' ...	3/9
B358/210	Rear, Ladies' ...	4/3

Gen.—Sturmey-Archer (New Type) Pattern

B359/209	Front GD431 ...	4/1
B359/304	Rear GD433 ...	5/-

CONTROL CABLE, NON-FRAY
Supplied in 50-ft. coils

	Per coil
B361/Trade ...	4/-
B362/Trade ...	4/7

OUTER CASING SUPPLEFLUTE
Fluted Finish

Available in black, silver, red, Blue, yellow, green and white. Supplied in 50-ft. coils.

B364/700 coil ...	per ft. 3d.
-------------------	-------------

GILL'S OUTER CASING
Flamboyant Colour

Superior quality casing available in silver, red, blue, yellow, green. Supplied in 50-ft. coils. Size 2.

395/900 ...	coil 13/6
-------------	-----------

5015—B.S.A. (Old Type) Pattern Pear Nipples

B345/1400 doz.	Front ...	1/9
B345/1803 doz.	Rear, Gents' ...	2/3
B345/2004 doz.	Rear, Ladies' ...	2/6

5039—B.S.A. (Streamlite) Pattern (T Nipple)

		Each
B346/1400 doz.	Front ...	1/9
B346/1803 doz.	Rear, Gents' ...	2/3
B346/2004 doz.	Rear, Ladies' ...	2/6

5044—B.S.A. Sports Pattern Gold Vase ($\frac{1}{4}$ Barrel, No. 2 Wire)

B347/1207 doz.	Front ...	1/7
B347/1610 doz.	Rear, Gents' ...	2/1
B347/1807 doz.	Rear, Ladies' ...	2/4

5016—Webb Pattern

B348/1400 doz.	Front ...	1/9
B348/1803 doz.	Rear, Gents' ...	2/3
B348/2004 doz.	Rear, Ladies' ...	2/6

5013—Hercules (Old Type) Pattern ($\frac{1}{4}$ Barrel Nipples)

B349/1610 doz.	Front ...	2/1
B349/2100 doz.	Rear, Gents' ...	2/7
B349/2207 doz.	Rear, Ladies' ...	2/10

No. 5046 WEINMAN PATTERN Pear Nipple

		Each
B355/1207 doz.	Front ...	1/7
B355/1610 doz.	Rear, Gents' ...	2/1
B355/1811 doz.	Ladies' Rear ...	2/5

THREE-SPEED CABLES
Top Tube Control

No. 5025. For Sturmey-Archer. Length, 32", 33" or 36".

B367/604 doz.	each 9d.
--------------------	----------

Handlebar Snap Control

No. 5022. For B.S.A. 25" Casing.

B369/1111 doz. ...	each 1/6
--------------------	----------

No. 5053. For B.S.A. Latest pattern. 43" Casing.

B370/1111 doz. ...	each 1/6
--------------------	----------

Handlebar Trigger Control

No. 5027. Silver. For Sturmey-Archer New Trigger pattern. Lengths, 50", 52", 54", 56" or 58".

B373/1111 ...	each 1/6
---------------	----------

All Prices plus 5%

5042—Hercules (1949) Pattern (Pear Nipples)

B350/1610 doz.	Front ...	2/1
B350/2106 doz.	Rear, Gents' ...	2/7
B350/2207 doz.	Rear, Ladies' ...	2/10

5029—Monitor Pattern

B351/910 doz.	Front ...	1/3
B351/1308 doz.	Rear, Gents' ...	1/8
B351/1600 doz.	Rear, Ladies' ...	2/-

5029—Phillips Vox Populi Pattern

		Each
B352/910 doz.	Front ...	1/3
B352/1308 doz.	Rear, Gents' ...	1/8
B352/1600 doz.	Rear, Ladies' ...	2/-

5037—Doherty (New Type) Pattern ($\frac{9}{32}$ Barrel) No. 1 Wire

B353/910 doz.	Front ...	1/3
B353/1308 doz.	Rear, Gents' ...	1/8
B353/1600 doz.	Rear, Ladies' ...	2/-

5031—G.B. Pattern (No. 2 Wire)

B354/1207 doz.	Front ...	1/7
B354/1600 doz.	Rear, Gents' ...	2/-
B354/1807 doz.	Rear, Ladies' ...	2/4

THREE-SPEED CABLES
5035—Simplex Cables

B374/805 doz. ...	each 1/1
W5035—Simplex Inner Wires only	
B376/403 doz. ...	each 6d.
W5050—Simplex Inner Wire	
B377/500 doz. ...	each 7½d.

BRAKE INNER WIRES
NON-FRAY INNER WIRES
FOR CALLIPER BRAKES

With soldered nipple and loose nipple.

No. 1 Wire with Pear Nipple

B380/403 doz.	WT1-F Front ...	each 6½d.
B381/604 doz.	WT1-G Gents'...	each 10d.
B382/708 doz.	WT1-L Ladies'...	each 11d.

No. 1 Wire with $\frac{9}{32}$ " Barrel Nipple

B383/403 doz.	WB1-F Front ...	each 6½d.
B384/604 doz.	WB1-G Gents' ...	each 10d.
B385/708 doz.	WB1-L Ladies'...	each 11d.

No. 2 Wire with Pear Nipple

B386/411 doz.	WT2-F Front ...	each 7½d.
B387/700	WT2-G Gents' ...	each 10½d.
B388/805	WT2-L Ladies'...	each 11/1

No. 2 Wire with $\frac{9}{32}$ " Barrel Nipple

B389/411 doz.	WB2-F Front ...	each 7½d.
B390/700	WB2-G Gents' ...	each 10½d.
B391/805	WB2-L Ladies'...	each 11/1

Each Wire in Sealed Waterproof Packet.
Makers' Names are used for Reference Purposes only.

Y-F-33

W. G. CHEESE LIMITED
CYCLE AND MOTOR ACCESSORIES, WIRELESS
AND ELECTRICAL SUNDRIES

JUPITER HOUSE
326-327, BRADFORD ST., BIRMINGHAM, 5
Telephone: MIDland 5804/5 (2 lines)

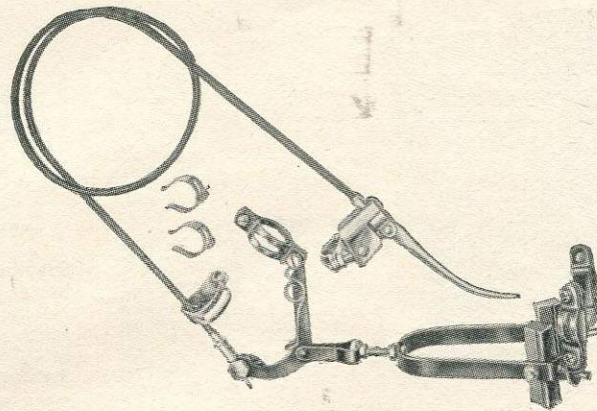

No. 444

WESTWOOD CABLE BRAKES

Complete with Waterproof Covered Black Cables and No. 11 Pattern Lever.

No. 405. Front Brake. $\frac{7}{8}$ " D Fork Clips as Standard, $\frac{3}{4}$ " D or $\frac{3}{8}$ " Round supplied to order.

B430/900 each 13/6

No. 444. Rear Brake. Model E Leg Clip Fastening, $\frac{7}{8}$ " D Stay Clips as standard, $\frac{3}{4}$ " Round to order. Suitable for use on Motorised Bicycles. Outsize Stirrup for 2" tyres extra.

B431/709 each 11/8

No. 410. Rear Brake. For seat-stay attachment. Suitable for use on Motorised Bicycles. $\frac{3}{4}$ " D Stay Clips as standard. $\frac{3}{4}$ " or $\frac{3}{8}$ " Round supplied to order. Outsize Stirrup for 2" tyres extra.

B432/903 each 13/11

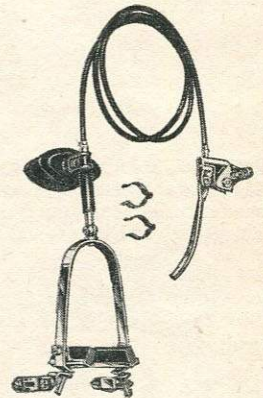

No. 410

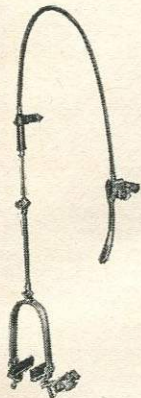

No. 405

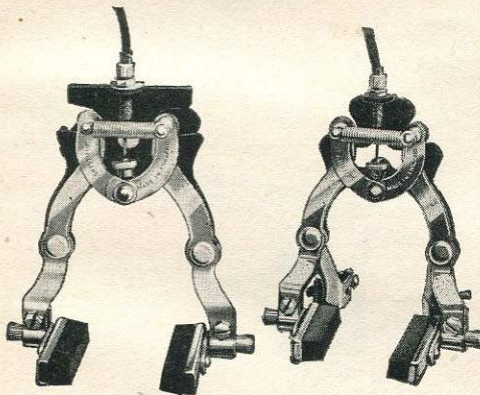

PHILCO CABLE BRAKES

Complete with black enamelled cable and No. 11 Pattern Lever.

No. 115. Front Brake. With $\frac{7}{8}$ " D Clips as standard for fitting to front forks.

B433/704 each 11/-

No. 116. Rear Brake. With Back Plate, Pin and Nut, for fitting to any type of Seat Stays. No Stay Clips required.

B434/709 each 11/8

VENTURA BRAKES

B451/800 Front each 12/-

B452/803 Rear each 12/5

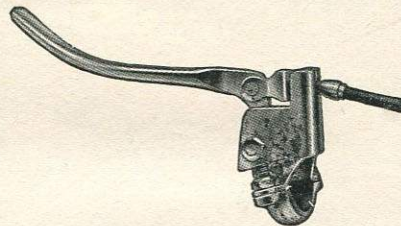

PHILLIPS BRAKE LEVER UNIT

No. 11. Supplied as standard with Philco, Sellwell, Vox Populi, Grand Vitesse, and Westwood Cable Brakes and Crabbe Hub Brakes.

B435/Trade each 2/7

RESILION BRAKES

Chromium plated. Silver cable. No. 14 lever.

B436/1405 Front each 21/8

B437/1405 Rear, Gent's each 21/8

B438/1405 Rear, Lady's each 21/8

B439/1405 Tandem, Front each 21/8

B440/1508 Tandem, Rear each 23/6

RESILION BRAKE CABLES

B441/500 Front each 7/6

B442/505 Rear, Gent's each 8/3

B443/508 Rear, Ladies' each 8/6

B444/609 Rear, Tandem each 10/2

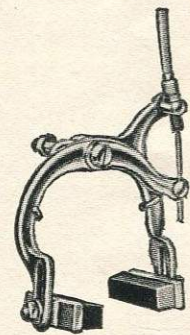

PHILLIPS VOX POPULI CABLE BRAKES

Complete with waterproof covered cables and No. 11 Hooded Pattern Lever. Silver cables supplied as standard, black to order.

No. 400. Front Brake. **B447/710** each 11/9

No. 401. Gent's Rear Brake. **B448/803** each 12/5

No. 402. Lady's Rear Brake. As No. 401 but with inverted cable fitting. **B449/803** each 12/5

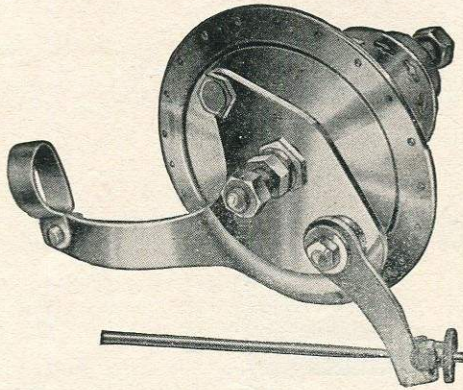

PHILLIPS "CRABBE" HUB-BRAKES

All models are fitted with $\frac{3}{8}$ " Spindles. Cable control models have spindles flattened to $\frac{5}{16}$ ". Front Hub-Brakes are drilled 32 holes and Rear Hub-Brakes 40 holes, and are suitable for 13 and 14 gauge spokes. 36H Front and 36H Rear supplied to order. All Phillips "Crabbe" hub-brakes have the linings individually ground to size.

Rod Transmission

- No. 246.** Front Hub-Brake. Complete with Rod, Fork Crown Stirrup and Brake Tube.
B502/2210 each 34/3
- No. 247.** Rear Hub-Brake. Complete with brake bottom parts. Supplied as standard with bolt fastening at bottom head lug and clip fastening at bottom bracket. Ready for use with standard handlebars and rear brake top parts.
B503/2210 each 34/3
- No. 246F.** Front Hub-Brake. As No. 246, but with balanced flange.
B504/2309 each 35/8
- No. 247F.** Rear Hub-Brake. As No. 247, but with balanced flange.
B505/2309 each 35/8

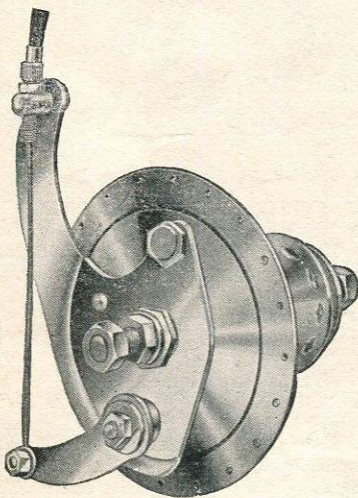

PHILLIPS CABLE TRANSMISSION

- Adjustment of brake end of cable.
- No. 248.** Front Hub-Brake. Complete with Cable and No. 11 Lever.
B509/2210 each 34/3
 - No. 249.** Rear Hub-Brake. Complete with Cable and No. 11 Lever, but without G.C.C. Screwed for cog and lock-ring.
B510/2210 each 34/3
 - No. 249G.** Rear Hub-Brake. As No. 249, but with G.C.C. Screwed for free wheel.
B512/2210 each 34/3
 - No. 248F.** Front Hub-Brake. As No. 248, but with balanced flange.
B513/2309 each 35/8
 - No. 249F.** Rear Hub-Brake. As No. 249, but with balanced flange.
B516/2309 each 35/8

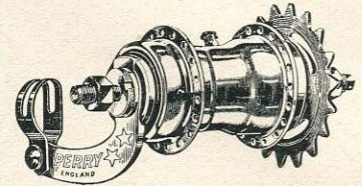

PERRY HUB COASTER BRAKE

Supplied in $1\frac{1}{2}$ " and $1\frac{5}{8}$ " chain lines, this variation being obtained by reversing the sprocket. Hubs are drilled 36 and 40 holes. The following range of sprockets is supplied $\frac{1}{2}$ " pitch $\times \frac{1}{8}$ " or $\frac{3}{16}$ " wide. 15T, 16T, 17T, 18T, 19T, 20T, 22T. Standard (including up to 22T sprocket).

B518/1908 each 29/6

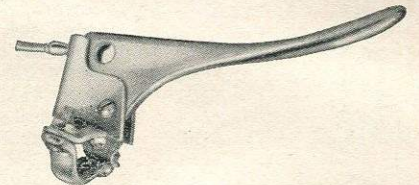

PHILLIPS CABLE BRAKE LEVERS

- No. 18.** With a solid forged lever, Tourist Pattern.
B533/Trade each 2/11

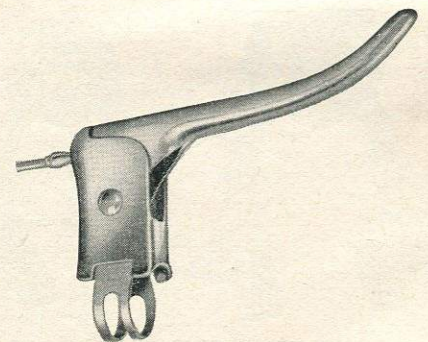

PHILLIPS CABLE BRAKE LEVERS

- No. 23** Hooded pattern.
B531/Trade each 4/7
- No. 14.** Steel Hooded Tourist Pattern.
B532/Trade each 2/11
- No. 25.** Hooded pattern. With heat-hardened light alloy lever and aluminium bracket. Supplied as standard with Grand Prix Brakes.
B530/Trade each 5/1

V H 10

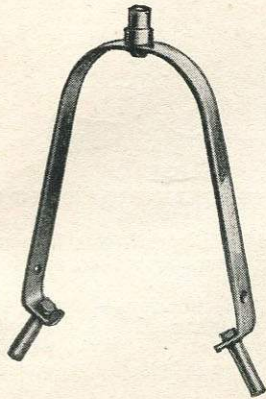

PHILLIPS FRONT BRAKE STIRRUPS B606/Trade

Ref.	Suitable for:—	Per doz.
B101f	All Standard Models	17/1
B116f	Yoke and Hinge	24/9
B105f	Carrier Pattern	21/1
B102f	Kiddies	16/9
B106f	Juvenile	17/1



PHILLIPS FORK CLIPS AND PINS For Front Brakes B607/Trade

Ref.	Suitable for:—	Per doz.
B1603x	Standard 7/8" D	9/1
B1625x	Standard 1 1/8" D	10/8
B1624x	Standard 1 1/8" Round	11/3
B1614x	Standard 1 1/8" Round	11/3
B1616x	Kiddies	9/1
B1629x	Yoke and Hinge	11/3

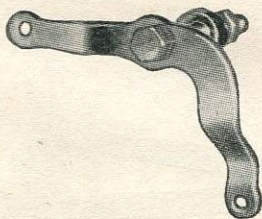

PHILLIPS BELL CRANK LEVER UNITS

Comprising Lever, Bolt, Bush, Washer and Nut. For Rear Brakes.

B595/Trade

Ref.	Suitable for:—	Per doz.
B1006x	{ All Standard Models Carrier Pattern }	11/5
B1023x	Kiddies	11/5
B1007x	Yoke and Hinge	24/1



PHILLIPS BRAKE LEVER UNITS

With Nut and Washer. Please specify Left-Hand or Right-Hand.

Ref.	For Handlebar Type:—	per doz.
B1112x	North Road raised.	14/7
B576/Trade	...	14/7
B1113x	North Road dropped.	14/7
B577/Trade	...	14/7
B1101x	Ordinary raised.	13/11
B578/Trade	...	13/11
B1122x	Ordinary raised 20".	14/3
B579/Trade	...	14/3
B1115x	{ Juvenile North Road raised. Kiddies North Road raised.	14/3
B580/Trade	...	14/3

Ref.	For Handlebar Type:—	per doz.
B1118x	Carrier.	14/8
B583/Trade	...	14/8
B1119x	Celtonia flat 16".	13/11
B584/Trade	...	13/11
B1120x	Celtonia flat 18".	13/11
B585/Trade	...	13/11
B1121x	Celtonia flat 20".	14/3
B586/Trade	...	14/3



PHILLIPS PLUNGER RODS AND ARMS

Front	Rear	For Handlebar Type:
B1001x	B1002x	{ North Road raised North Road dropped Ordinary raised
B587/Trade	...	per doz. 8/-
B1001x	B1022x	Juvenile N.R. raised.
B588/Trade	...	per doz. 8/-
B1011x	B1022x	Kiddies N.R. raised
B588/Trade	...	per doz. 8/-
B1001c	B1002c	Carrier.
B589/Trade	...	per doz. 8/-
B1011x	B1012x	Yoke and Hinge.
B590/Trade	...	per doz. 8/-

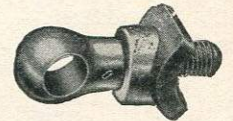

PHILLIPS SCREW-IN STUD UNITS

Ref.	For Handlebars:—	per doz.
B1801B	(Outer) All Standard and Juvenile Models.	7/3
B599/Trade	...	7/3
B1801L	(Inner) All Standard and Juvenile Models.	7/3
B600/Trade	...	7/3
B1801K	Kiddies.	7/3
B601/Trade	...	7/3



PHILLIPS PLUNGER ARMS

Front	Rear	For Handlebar Type:
B1001	B1002	All Standard Models.
B591/Trade	...	per doz. 5/-
B1011	B1022	Kiddies N.R. raised.
B592/Trade	...	per doz. 5/-
B1001	B1022	Juvenile.
B593/Trade	...	per doz. 5/-
B1011	B1012	Yoke and Hinge.
B594/Trade	...	per doz. 5/-

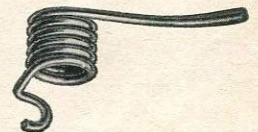

PHILLIPS FRONT BRAKE SPRINGS

Suitable for All Models.

Q101	R.H.	2/3
Q102	L.H.	2/3
B602/Trade	...	2/3



PHILLIPS BELL CRANK BOLT UNITS

Ref.	Suitable for:—	per doz.
S804x	Standard and Carrier. Rear Brake.	7/3
B596/Trade	...	7/3
S817x	Kiddies. Rear Brake.	7/3
B597/Trade	...	7/3
S610x	Yoke and Hinge. Rear Brake.	7/3
B598/Trade	...	7/3

PHILLIPS BELL CRANKS

For Rear Brakes.

Ref.	Suitable for:—	per doz.
B1006	All Standard Models and Carrier Pattern	5/7
B1007A	Yoke and Hinge	17/7
B1023	Kiddies	5/7

O 25

W. G. CHEESE LIMITED
CYCLE AND MOTOR ACCESSORIES, WIRELESS
AND ELECTRICAL SUNDRIES

JUPITER HOUSE
326-327, BRADFORD ST., BIRMINGHAM, 5
Telephone: MIDland 5804/5 (2 lines)



PHILLIPS REAR BRAKE CONNECTION SCREW UNITS
B630/Trade

Ref.	Suitable for:—	
S608x	All Standard Models	per doz. 3/9
S607x	Juvenile	per doz. 3/7



PHILLIPS REAR BRAKE BOTTOM BRACKET STUD UNIT
B631/Trade

Ref.	Suitable for:—	
B1404x	All Models	per doz. 5/7



C201x

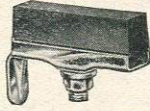

C209x

PHILLIPS STANDARD BRAKE SHOES AND RUBBERS
B643/Trade

	Carded	Per
Ref.	Suitable for:—	doz. prs.
C201x	Front Brakes Nos. 400, 417, 519, 524	12/8
C209x	Rear Brakes Nos. 401, 402, 403, 418, 419, 520, 522, 523, 525, 526, 527, 528, 404, 521	16/5



PHILLIPS BRAKE TUBE UNITS
Tube, with Top and Swivel Joints
B633/Trade

Ref.	Suitable for:—	Per doz.
B301r	All Models. Rear Brake ...	14/5
B302r	Carrier Pattern. Rear Brake	20/8
Tube with Top and Swivel Joint		
B301F	All Models. Front Brake ...	11/9
B302F	Carrier Pattern. Front Brake	17/11
Tube only		
B301	All Models	8/9
B302	Carrier Pattern	11/9

Please specify length of tube required



Top Joint



Swivel Joint



Swivel Joint Pin

PHILLIPS TOP AND SWIVEL JOINTS
B635/Trade

Ref.	Suitable for:—	Per doz.
B401	Top Joint. All Models ...	4/11
B405	Top Joint. Carrier Patt. Stan.	6/9
B403	Top Joint. Low Gravity Patt.	6/9
B703	Swivel Joint. All Models ...	5/3
B712	Swivel Joint. Carrier Pattern	7/3
Swivel Joint Pins		
S606	All Models	9d.
S626	Carrier Pattern	9d.



PHILLIPS TOP JOINT PIN, NUT AND WASHER
B636/Trade

Ref.	Suitable for:—	Per doz.
B501x	All Models. Front Brake ...	3/3
B502x	Carrier Pattern	4/3



PHILLIPS REAR BRAKE LEG UNIT
B642/Trade

Model "S". Comprising Leg, Bottom Bracket Stud Unit, Connection Link, and Pivot Bush Unit.

Ref.	Suitable for:—	Per doz.
B1009x	All Models	15/4
B1010x	Kiddies	15/4
B1010z	Yoke and Hinge	15/4

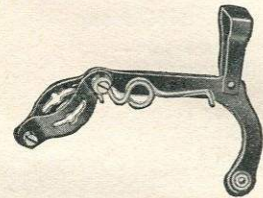

PHILLIPS REAR BRAKE LEG UNIT
B639/Trade

Model "E". Comprising Leg, Seat Tube Clip, Spring, Connection Link, and Pivot Bush Unit.

Ref.	Suitable for:—	Per doz.
B1005x	All Standard Models (1 1/8" clip)	18/4
B1005k	Juvenile (with 1" clip) ...	18/4



PHILLIPS CENTRE BOLT UNIT FOR VOX POPULI, GRANDE VITESSE, SUPER CLUB

	Per doz.
B643/Trade S806v	Front centre bolt unit 15/-
B644/Trade S815v	Rear centre bolt unit 15/-

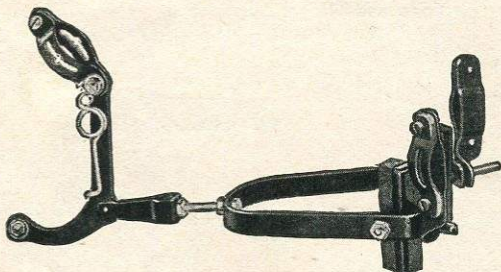

PHILLIPS REAR BRAKE STIRRUP UNIT
Clip Fastening Model "E"
B645/Trade

Comprising Leg, Seat Tube Clip, Spring, Connection Screw Unit, Stirrup, Brake Shoes and Blocks, Stay Clips, and Pivot Bush Unit.

B101e	Standard	per doz. 44/1
B105e	Carrier Pattern	per doz. 59/3
B106e	Juvenile	per doz. 44/1
B101y	Yoke and Hinge	per doz. 44/1

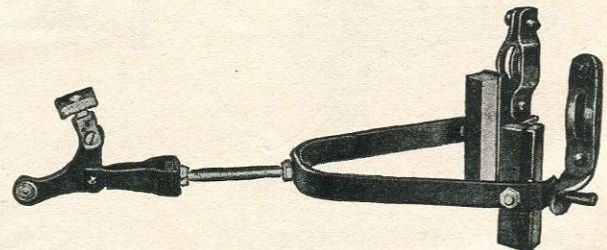

PHILLIPS REAR BRAKE STIRRUP UNIT
Stud Fastening Model "S"
B646/Trade

Comprising Leg, Bottom Bracket Stud Unit, Connection Screw Unit, Stirrup, Brake Shoes and Blocks, Stay Clips and Pivot Bush Unit.

B101s	All Standard Models	per doz. 42/7
B105s	Carrier Pattern	per doz. 62/1
B106s	Juvenile	per doz. 42/7
B102s	Kiddies	per doz. 42/7
B101z	Yoke and Hinge	per doz. 42/7



ALBION SOLDERLESS NIPPLES

				Cards of 36	
B704/Trade	1936	Standard	per card	7/-
B705/Trade	1936N	Barrel type $\frac{1}{4}$ "	per card	7/-
B706/Trade	1936M	Barrel type $\frac{3}{8}$ "	per card	9/4
B707/Trade	1936BX	Assorted 12 of each type		per card	8/-
B708/Trade	503C	Cable Nipples and Fittings		per card	10/8

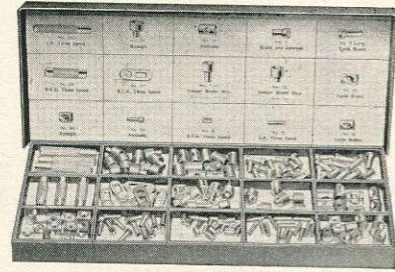

TERRY CABLE NIPPLES

No. 1247. One box containing 13½ dozen assorted Cycle Cable Nipples.
 B714/1304 per box 20/-

TERRY CABLE NIPPLES AND STOPS

B716/K

Prices per gross

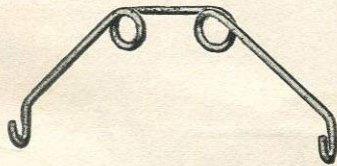

Q301



Q701

PHILLIPS CABLE BRAKE LEG SPRINGS

B710/Trade

Ref.	Suitable for:—			
Q301	Vox Populi, middleweight	per doz.	3/8
Q306	Grand Prix and Vox Populi	per doz.	3/8
Q305	Grande Vitesse	per doz.	3/8
Q701	Philco	per doz.	2/4

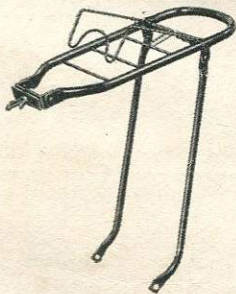

BROOKS TUBULAR CARRIER

No. 60. Fitted with spring clip. Spindle fitting for 26" or 28" wheels. Size 15" x 6¼". Black enamel finish.

C5/500 each 7/6



TERRY BASKET SUPPORT

No. 1140. Holds basket firmly and prevents it pressing against brake rods. Black enamel finish.

C6/200 each 3/-



No. 36
Raleigh Ladies' Rear Stop
27/6



No. 1
Brake and General
12/-



No. 1 Long
Cycle Brake
12/6



No. 9
Valve Lifter and Cycle Brake
18/-



No. 14
B.S.A. Acorn
15/-



No. 15
Triumph
12/6



No. 16
Ariel
21/-



No. 17
Enfield
27/6



No. 19
Caliper Brake Stop
15/-



No. 21
Cycle Brake and Valve Lifter
18/-



No. 22
Hercules Brake
12/-



No. 23
Hercules Brake
18/-



No. 24
Raleigh
21/-



No. 27
B.S.A. 3-Speed
27/6



No. 28
Raleigh
18/-



No. 33
S.A. Long
24/-

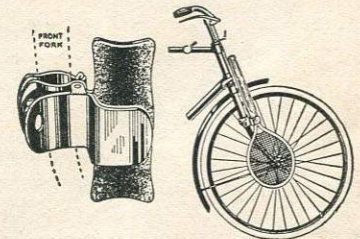

TERRY TENNIS RACKET CARRIER
 No. 787. Silver finish.
 C7/208 each 4/-

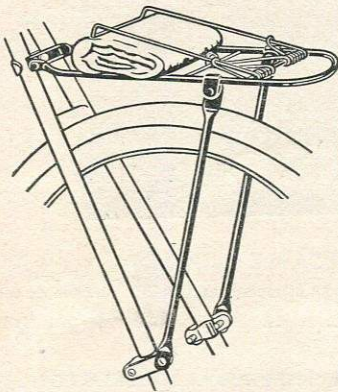

LLOYD'S LIGHT TOURIST CARRIERS

No. 70. Steel. Black enamelled. Fit either round or "D" seat stays. $\frac{3}{8}$ " dia. steel tube.
C16/402 each 6/3

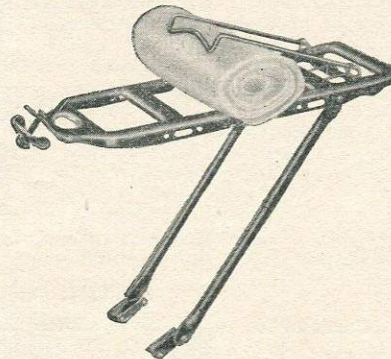

MIDLAND "SUPREME" CARRIERS

Roadster Models. Solid steel one-piece pressing to tubular form. Spring top attachment. Enamel finish.

- Size: 15" x 6 $\frac{1}{4}$ ".
No. 4651. With clips for stay fitting.
No. 4652. Spindle fitting for 26" wheels.
No. 4653. Spindle fitting for 28" wheels.
C20/504 each 8/-

As above but without spring top attachment
No. 4648. With clips for stay fitting.
No. 4649. Spindle fitting for 26" wheels.
C21/408 each 7/-

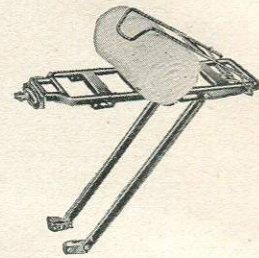

MIDLAND "SUPREME" CARRIERS

Sports Models. Solid steel one-piece pressing to tubular form. Spring top attachment. Enamel finish. Size 15" x 5".
No. 4614. With clips for stay fitting.
No. 4615. Spindle fitting for 26" wheels.
C17/502 each 7/9
 As above but without spring top attachment.
No. 4576. With clips for stay fitting.
No. 4577. Spindle fitting for 26" wheels.
C18/404 each 6/6

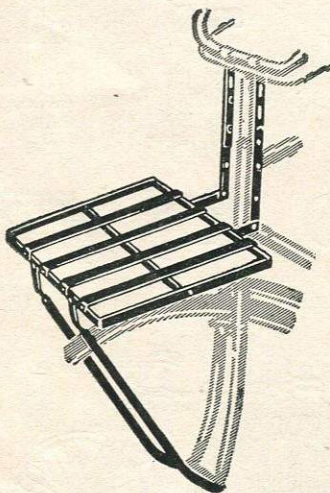

ASHBY TRADE CARRIER

No. 59. Flat type. Suitable for messenger use.
C22/1500 each 22/6

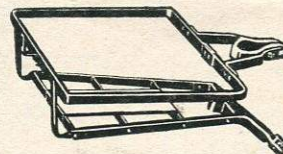

ASHBY "SAMSON" TRADE CARRIER

No. 7. Rigid design with heavy duty fittings for attachment to head and down tube. Size: 18" x 12". Fits any size frame. Enamelled black.
C24/1608 each 25/-

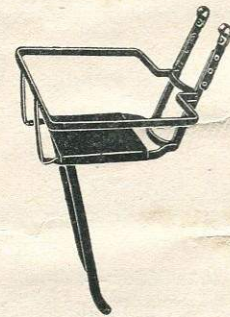

ASHBY "CLIPON" TRADE CARRIER

No. 20S. For attachment to front spindle and handlebars. Adjustable fittings to suit any size frame or handlebar position. Size: 18" x 12". Enamelled black.
C23/1608 each 25/-

A.J.S. CARRIER

No. 70. Wire, spring clip sports carrier. Mudguard eye fitting, chrome plated. 26/28" wheels. Attaches to brake pivot bolt.
C25/608 each 10/-

B 272

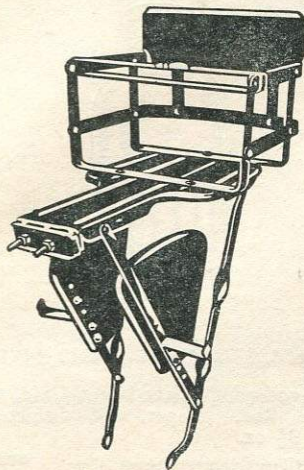

ASHBY "BABSCAR" CARRIER

No. 15. Improved model. A dual purpose carrier with leg shields which close the gap between the carrier arms and the footrest arms. The child carrier portion is adjustable for position, and detachable to provide a normal carrier. Strong double twist arms, double attachment to rear forks, pressed steel platform, adjustable footrests and safety strap. For 26" or 28" wheels. Enamelled black.

C32/1808 each 28/-

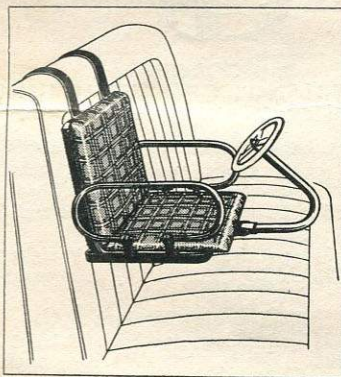

LECO JUNIOR DRIVER'S SAFETY SEATS

Padded seat and back, tubular steel arm rests. Finished in steel stove enamel and upholstered in a variety of shades. Suitable for all makes of cars.

No. L/4. Without steering wheel.

C35/2104 each 33/-
Plus Purchase Tax 1/-

No. L/3. With steering wheel.

C36/2304 each 36/2
Plus Purchase Tax 1/1½

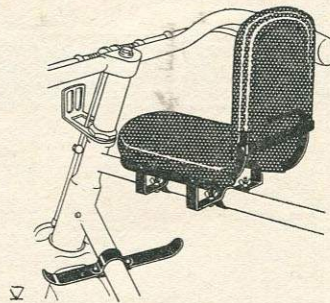

LECO JOYRIDER CROSS-BAR SEAT

No. L/12-9. Padded and light in weight. Secured by easily accessible wing nuts. Folds flat when not in use. Various colours available. Complete with footrests.

C39/900 each 13/6

LECO PORTABLE HIGH-CHAIR

No. L/5. The two hooks are easily slipped over the back of a car seat or a chair, and are covered in a plastic sheath to avoid danger to leather. With play tray.

C37/2704 each 41/-



LECO KIDDY CARRIERS

Strong steel strip frame with tubular arm rests. Supplied with or without fitted cushions. Leg stays fit to spindle of rear wheel and a two-bolt non-slip clamp secures at seat stay. Metal work finished in black stove enamel. Upholstery in Black, Green and Maroon. When not in use as a child's carrier, the back-rest folds forward, and the arm-rest inward, to form a perfectly flat and useful luggage carrier.

C40/1704. No. L/7. Non-padded each 26/-

C41/2000. No. L/6. Padded ... each 30/-

C42/108. No. L/11. Footshields pair 2/6

NEWCRAFT KIDDIE SEAT

Junior de luxe rear child carrier, silver-chrome arms. Soft padding.

C43/2408 each 37/-

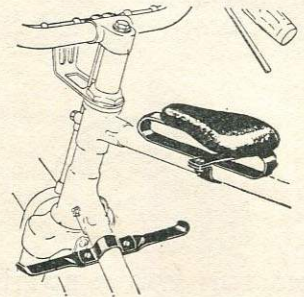

LECO TOP TUBE SADDLE AND FOOT REST

No. L8/9. Strong metal frame, with comfortable thickly padded seat set into a pressed metal shape. Foot rests fitted to down tube. Available in Black, Green and Maroon.

C44/608 each 10/-

LECO FOOT RESTS

An easily fitted accessory for use with pillion seats not fitted with foot rests.

C46/108. **No. L/10.** Rear ... per pair 2/6



LECO FOLDING PRAM SET

No. L/1. For high coach-built prams.

C50/2304 each 35/-

No. L/2. Universal Model, particularly suitable for low built prams with drop fronts.

C51/2304 each 35/-

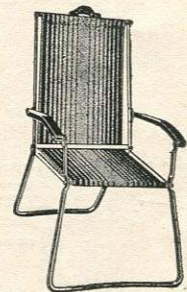

DESMO No. 66 "RESTATEZE" CHAIR

It can be used for practically every purpose in the house and garden, and can be folded flat to 23" x 24" x 2½" for storage when not in use. The height of the seat from the ground is 16" and together with the shaped metal armrests provides perfect comfort in each of its many uses. The strong, tubular legs have no sharp edges or corners to damage carpets or other floor coverings, and the high-grade canvas is of an exclusive design which is attractive in appearance and hard wearing in use.

C53/3309 each 45/-

Plus Purchase Tax 1/8

W. G. CHEESE LIMITED
CYCLE AND MOTOR ACCESSORIES, WIRELESS
AND ELECTRICAL SUNDRIES

JUPITER HOUSE
326-327, BRADFORD ST., BIRMINGHAM, 5
Telephone: MIDland 5804/5 (2 lines)



KINGSTON WATER BOTTLE

Hygienic and unbreakable polythene. 20-oz. capacity. Self coloured in Silver, Red, Blue, Green or Yellow. Complete with cage.

C100/308 each 5/6

SIMPLEX BOTTLES

Made from special plastic, one colour only, Blue tint, complete with cap.

C101/204 each 3/6

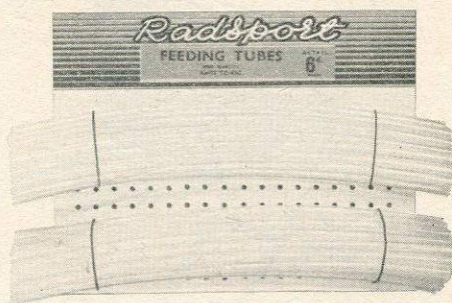

"RADSPORT" FEEDING TUBES

50 per card.

C110/1500 card each 6d.

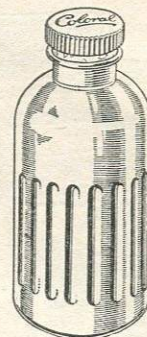

COLORAL STRAIGHT-SIDED BOTTLES

Polished and anodised in Silver, Gold, Green, Blue and Red. Height, 6³/₈", diameter, 3". Weight, 3¹/₄ oz.

C120/300 each 4/6

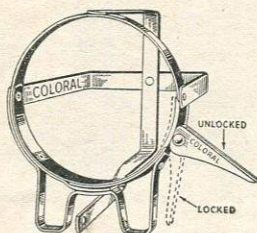

COLORAL SINGLE LOCKING CARRIER

Single lever operation. Polished and anodised in Silver, Gold, Green, Blue and Red. Height 4³/₈", width 7¹/₂", depth 4¹/₂". Weight 2 oz.

C105/300 each 4/6

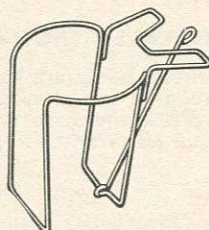

COLORAL STEEL WIRE SINGLE CARRIER

Chromium plated. Handlebar or down tube. Height, 4¹/₂". Width, 3¹/₂". Depth, 4¹/₂". Weight 3 ozs.

C112/204 each 3/6

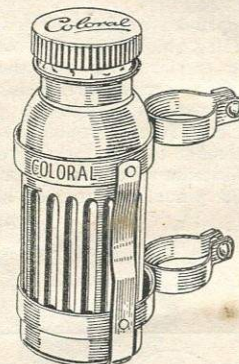

COLORAL "ONE-HAND" OPERATION JUNIOR BOTTLES AND CARRIERS

Down tube model carrier. Both single and double carriers are available for handlebar fitting. Capacity 1/3 pint. Polished and anodised in Silver, Red, Green, Blue and Gold.

Single Carriers

Height 3³/₄", width 2¹/₂", depth 4". Weight 1 oz. C125/106 each 2/3

Double Carriers

Height 3³/₄", width 4¹/₂", depth 4". Weight 2 oz. C126/208 each 4/-

Aluminium Bottles

Height 5¹/₂", diameter 2". Weight 1³/₄ oz. C127/200 each 2/11

COLORAL POLYTHENE BOTTLES

Coloured Silver, Red, Blue, Green or Gold.

Standard one-pint size

C128/202 each 3/3

Junior half-pint size

C129/106 each 2/3

COLORAL BOTTLE CORKS

C132/400 per doz. 6/-
C133/404 Drilled per doz. 6/6

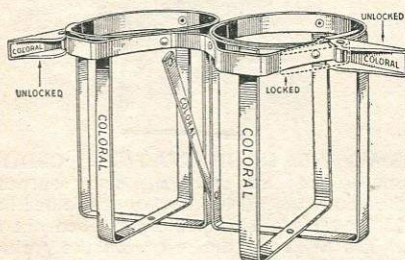

COLORAL DOUBLE LOCKING CARRIER

Single lever operation. Polished and anodised in Silver, Gold, Green, Blue and Red. Height 4³/₈", width 7¹/₂", depth 4¹/₂". Weight 4 oz.

C107/502 each 7/9

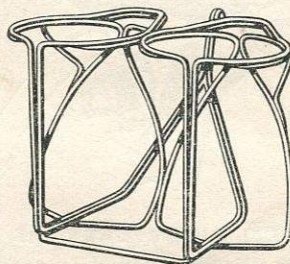

COLORAL STEEL WIRE DOUBLE CARRIER

Chromium plated. Bottle held by spring top. Suitable for standard straight or taper bottles. Complete with clips. Height, 4¹/₂". Width, 7". Depth, 4¹/₂". Weight, 5 ozs.

C114/404 each 6/6

STRATA BOTTLE CAGES

Latest Continental style chrome wire cage with front spring. Down tube fitting.

C116/304 each 5/-

H/Bar fitting.

C118/310 each 5/9

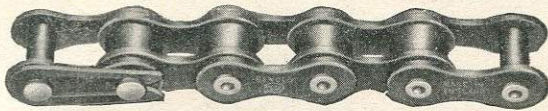

RENOLD "ELITE" CYCLE CHAIN

De luxe chain incorporating shouldered bearing pins. Standard length 98 to 120 pitches.

- Nos. 111 044 $\frac{1}{2}$ " Pitch \times $\frac{1}{8}$ " Inside Width.
 Nos. 111 046 $\frac{1}{2}$ " Pitch \times $\frac{3}{16}$ " Inside Width.
 C151/703 112 Pitches each 11/1

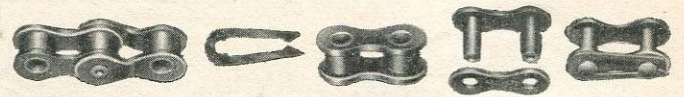

RENOLD AND THE COVENTRY CHAIN SPARES

- C160/100 doz. No. 4. Inner Links each 1½d.
 C161/07 doz. No. 107. Outer Links each 1d.
 C162/308 doz. No. 26. Connecting Link Single each 6d.
 C163/4½ doz. No. 27. Spring Clip Fastener each 1d.
 No. 30. Cranked Link Double:—
 C164/308 doz. For Renold "Elite" each 6d.
 C165/308 doz. For Coventry each 6d.
 C166/404 doz. For Coventry Trade Carrier each 7d.

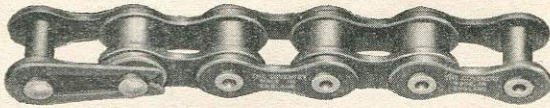

THE COVENTRY CYCLE CHAIN

Standard length 98 to 120 pitches.

- Nos. 111 048 $\frac{1}{2}$ " Pitch \times $\frac{1}{8}$ " Inside Width.
 Nos. 111 049 $\frac{1}{2}$ " Pitch \times $\frac{3}{16}$ " Inside Width.
 C152/601½ 120 Pitches each 8/8
 C153/508½ 112 Pitches each 8/8



COVENTRY TRADE CARRIER CHAIN

- A chain specially designed for heavy duty.
 Nos. 112 045 $\frac{1}{2}$ " Pitch \times $\frac{3}{16}$ " Inside Width.
 C170/906 ft. 120 Pitches each 14/3



BRAMPTON DERAILLEUR CYCLE CHAINS

- C154/701½ B12044 $\frac{1}{2}$ " \times $\frac{3}{32}$ " (98 to 120 pitches) each 10/10

PERRY CYCLE CHAIN SPARES

- $\frac{1}{2}$ " Pitch \times $\frac{1}{8}$ " or $\frac{3}{16}$ " Wide.
 C171/4½ doz. Spring Clip, No. 7 Each 1½d.
 C172/308 doz. Spring Clip Single Connecting Link, No. 6 6d.
 C173/308 doz. Double Cranked Link, No. 10 6d.

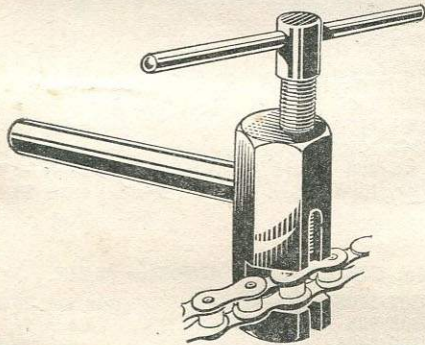

CYCLO CHAIN RIVET EXTRACTORS

- No. 158/R. "Rivoli". Rivets chain as well as extracting $\frac{1}{8}$ " and $\frac{3}{32}$ ".
 C155/405 each 6/7

WIPPERMAN SPRING LINKS

- $\frac{3}{32}$ "
 C185/304 doz. each 5d.

M.P. CYCLE CHAINS (British)

- $\frac{1}{2}$ " \times $\frac{1}{8}$ ". 112 links.
 C175/402 each 6/3

CHATER LEA FLUTED CRANKS

- Sizes, 6½", 6¾", 7".
 C158/4304 4508 per pair 65/-

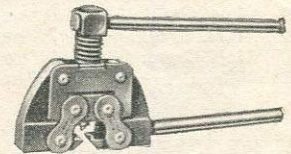

RENOLD CHAIN RIVET EXTRACTOR No. 311006

- For Chain Nos.: 110037, 110038, 110044, 110046, 110054, 110056, 110500, 114038, 114500.
 C182/1504½ each 20/6

CHATER CHAIN RINGS (Current prices charged)

CHAIN RING PINS

- Sets of three. $\frac{1}{4}$ " or $\frac{5}{16}$ ".
 C178/100 per set 1/6
 Sets of three. $\frac{1}{2}$ ".
 C179/102 per set 1/9

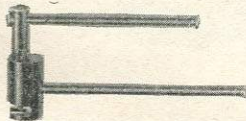

RENOLD CHAIN RIVET EXTRACTORS

- Nos. 311 015 For all cycle chains.
 C176/503 each 6/11

CHATER CRANK COTTERS

- C180/100-200 per pair 2/6

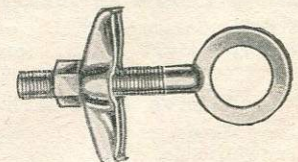

PHILLIPS CHAIN ADJUSTERS

- M901x. Roadster Type. Black or Cadmium finish. Carded.
 C183/Trade per doz. pairs 5/11

WILLIAMS CHAINWHEELS AND CRANKS

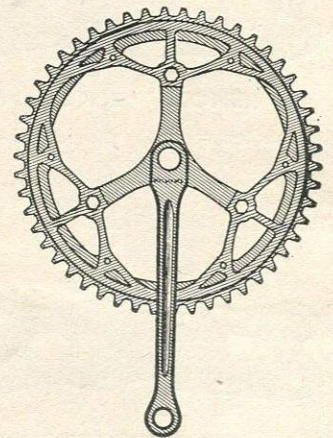
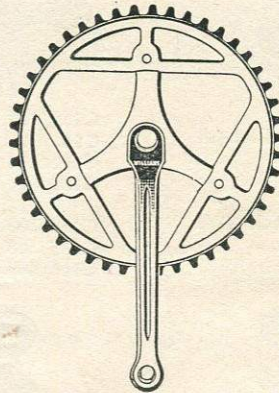
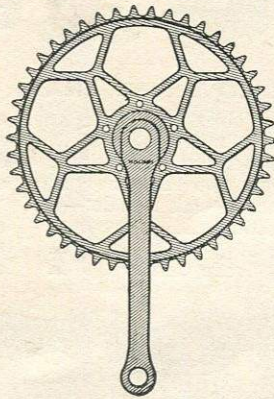

STANDARD SETS—C.P.

No. F100. 44, 46, 48T. $\frac{1}{2}'' \times \frac{1}{8}'' - 6\frac{1}{2}''$. G.C.C. or N.G.C.C.
 C245/1302 per set 19/9
 C246/404 L.H. Crank ... each 6/6

No. B100. 32T to 48T. $\frac{1}{2}'' \times \frac{1}{8}'' - 6\frac{1}{2}''$.
 C247/1709 per set 26/6
 C248/608 Rings ... each 10/-
 C249/504 L.H. Crank ... each 8/-
 C250/706 R.H. Crank ... each 11/3

No. C34. 32T to 48T. $\frac{1}{8}''$ or $-\frac{3}{32}''$. $6\frac{1}{2}''$.
 C251/1709 per set 26/6
 C252/608 Rings ... each 10/-
 C253/708 Rings over 48T ... each 11/6
 C254/504 L.H. Crank, $6\frac{1}{2}''$ or $7''$ each 8/-
 C255/706 R.H. Crank, $6\frac{1}{2}''$ or $7''$ each 11/3
 C256/510 L.H. Crank, Fluted, $6\frac{3}{4}''$ each 8/9
 C257/800 R.H. Crank, Fluted, $6\frac{3}{4}''$ each 12/-

No. C45. 46T, 47T, 48T. $\frac{1}{8}''$ or $\frac{3}{32}''$. Sleeved.
 258/1809 per set 28/-
 259/608 Rings ... each 10/-
 260/504 L.H. Crank, $6\frac{1}{2}''$... each 8/-
 261/706 R.H. Crank, $6\frac{1}{2}''$... each 11/3

NICKLIN TANDEM SET

42T—42T/48T. $\frac{1}{2}'' \times \frac{1}{8}''$.
 C263/3802 complete 57/3
 C264/1302 Front Set ... each 19/9
 C265/2600 Rear Set ... each 39/-

WILLIAMS CHAIN WHEEL PINS

C267/105 doz. Square Head ... each 2d.
 C268/202 doz. Slotted ... each $3\frac{1}{2}d$.

SLEEVE PINS

No. 1. For $\frac{1}{8}''$ Single.
 No. 2. For $\frac{1}{8}''$ Double.
 No. 3. For $\frac{3}{32}''$ Double.
 All above Sleeves.

C269/204 per set of 3 3/6

RACING SETS—C.P.

No. C1000. 44T to 48T. $\frac{1}{8}''$ or $\frac{3}{32}'' - 6\frac{1}{2}''$.
 C271/2606 per set 39/9
 C272/608 Rings ... each 10/-
 C274/803 L.H. Crank ... each 12/6
 C275/1209 R.H. Crank ... each 19/-

No. C1200. 46 to 50T. $\frac{1}{8}''$ or $\frac{3}{32}'' - 6\frac{3}{4}''$.
 C278/4800 per set 72/-
 C279/900 Rings to 48T ... each 13/6
 C280/1000 Rings over 48T ... each 15/-
 C281/1400 L.H. Crank, $6\frac{3}{4}''$... each 21/-
 C282/3004 R.H. Crank, $6\frac{3}{4}''$... each 45/6

SIMPLEX—STRONGLITE COMPETITION SETS

Doubles. 46/49T or 47/50T. $\frac{3}{32}''$.
 C284/5608 per set 85/-
 C285/2500 Double Rings ... each 37/6
 C286/3108 $6\frac{3}{4}''$ Cranks ... per pair 47/6
 C287/506 Ring Arms ... set of 3 8/3

CARRIER SETS—BLACK

No. F27. 46T. $\frac{1}{2}'' \times \frac{3}{16}'' - 6\frac{1}{2}''$.
 C288/1608 per set 25/-
 C289/600 L.H. Crank ... each 9/-

JUVENILE SETS—C.P.

36T or 40T. $\frac{1}{2}'' \times \frac{1}{8}'' - 5\frac{1}{2}''$.
 C291/1302 per set 19/9
 C292/404 L.H. Crank ... each 6/6

KIDDIES SETS—C.P.

C294/1103 32T. $\frac{1}{2}''$, $\frac{1}{8}'' - 4''$... each 16/9
 C295/804 28T. $\frac{1}{2}''$, $\frac{1}{8}'' - 4''$... each 12/6
 C296/804 22T. $\frac{1}{2}''$, $\frac{1}{8}'' - 4''$... each 12/6
 C297/304 L.H. Crank, $4''$... each 5/-

STANDARD CRANK COTTERS

C298/3100 gross C.P. ... each 4d.
 C299/209 doz. C.P. ... each 4d.

DOUBLE SETS

No. C34D. Any Sizes, 32T to 52T. All sleeve fixing.

C300/2800 per set 42/-
 Rings as C34's.
 Cranks as C34's.

C45D. Any Sizes, 46T to 50T. All sleeve fixing.

C301/2800 per set 42/-
 Rings as C45's.
 Crank as C45's.

No. C1032. 46/49T or 47/50T. $\frac{3}{32}'' \times 6\frac{1}{2}''$.
 C302/3606 per set 54/9
 C303/1104 Outer Ring ... each 17/-
 C304/906 Inner Ring ... each 14/3
 C305/804 L.H. Crank ... each 12/6
 C306/1206 R.H. Crank ... each 18/9

No. C1232. 46/49T, 47/50T or 48/51T. $\frac{3}{32}''$.
 C307/5708 (Fluted) ... per set 86/6
 C308/906 Inner Ring ... each 14/3
 C309/1206 Outer Ring ... each 18/9
 C310/1306 L.H. Crank, $6\frac{3}{4}''$... each 20/3
 C311/3100 R.H. Crank, $6\frac{3}{4}''$... each 46/6

No. F1016. 46/49T (Fixed). $\frac{3}{32}''$.
 C315/2304 per set 35/-
 C316/404 L.H. Crank, $6\frac{1}{2}''$... each 6/6

BRAMPTONS

46/49T. $\frac{1}{2}'' \times \frac{1}{8}''$ or $\frac{3}{32}''$.
 C317/2800 per set 42/-

Y P 42

W. G. CHEESE LIMITED
 CYCLE AND MOTOR ACCESSORIES, WIRELESS
 AND ELECTRICAL SUNDRIES

JUPITER HOUSE
 326-327, BRADFORD ST., BIRMINGHAM, 5
 Telephone: MIDland 5804/5 (2 lines)



CONTINENTAL CHAINGUARD

Ebony, Black or White.

C401/206 each 3/9

PHILLIPS KIDDIES' CHAIN GUARDS

No. 296. Supplied with $\frac{7}{8}$ " clips for Minor Models and $\frac{5}{8}$ " clips for Junior Models.

C400/Trade White each 3/1



MIDLAND JUVENILE TOP CHAIN GUARD

No. 110. Enamelled.

C412/208 White each 4/-



MIDLAND TOP CHAIN GUARDS

No. 136. For 26" wheels. Round Clip.

No. 139. For 26" wheels. "D" Clip.

No. 137. For 24" wheels. "D" Clip.

C414/204 Black each 3/6

C413/300 White each 4/6



MIDLAND

JUVENILE TRICYCLE CHAIN GUARDS

Hard gloss enamel finish. Clips and fittings available to suit a wide range of designs.

No. 143. Length, centre to end, $8\frac{5}{8}$ ".

No. 148. Length, centre to end, $9\frac{5}{8}$ ".

C415/302 White each 4/9

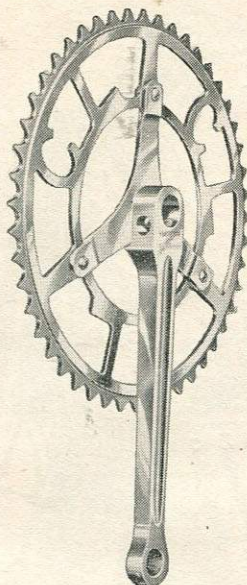

CHATER LEA CRANKS

$6\frac{1}{2}$ ", $6\frac{3}{4}$ " or 7" with Cotters.

C418/4304...4608 ... per pair 3-10-0

C419/1608 L.H. 1804. each 1-5-0

C420/2608 2804 R.H. ... each 2-0-0

Rings only. 46T—48T. $\frac{1}{8}$ " or $\frac{3}{32}$ ". 2-2-6.

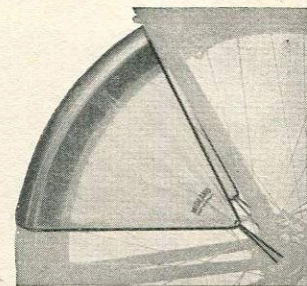

MIDLAND DRESS GUARDS

No. 4675. Made from plastic material in various colours.

C429/100 each 1/6

No. 4796. De luxe pattern in plastic.

C430/206 each 3/9

ASTON DRESS GUARDS

In heavy embossed plastic satin finish. Colours: Black, Natural, Blue and Red.

C432/1200 doz. each 1/6

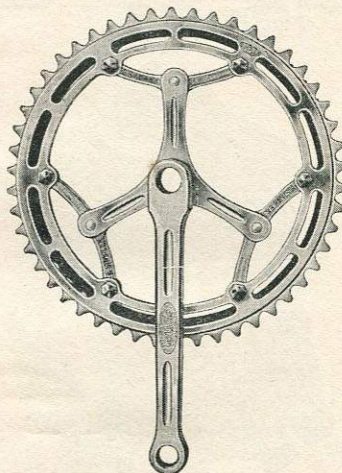

SIMPLEX DOUBLE RINGS AND ARMS

C422/2500 each 37/6

SIMPLEX ARMS ONLY

C423/110 each 2/9

SIMPLEX CHAIN WHEEL PINS

C424/100 each 1/6

SIMPLEX "STRONGLIGHT" COMPETITION CRANKS

As illustrated. 3-arm type. Ref. No. 55.
C425/3108 per pair 47/6

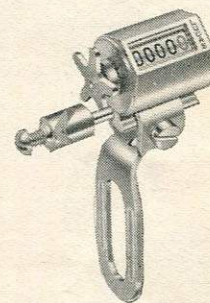

LUCAS CYCLOMETERS

Record up to 10,000 miles and then repeat. Clear figures record miles and tenths of a mile. Dustproof and waterproof. Complete with striker and rustproof hub spindle. Chromium plated.

No. M26 26" wheels. No. M27 27" wheels.

No. M28 28" wheels. No. M24 24" wheels.

C435/500 each 9/6

REPLACEMENT STRIKERS

C436/004 Standard (770152) ... each 8d.

Y B 40

W. G. CHEESE LIMITED
CYCLE AND MOTOR ACCESSORIES, WIRELESS
AND ELECTRICAL SUNDRIES

JUPITER HOUSE
326-327, BRADFORD ST., BIRMINGHAM, 5
Telephone: MIDland 5804/5 (2 lines)



"RADSPORT" P.V.C. CAPE

45". Fabric based. Superb Gold. Lined collar. Lightning zip.
C450/2111 each 32/10
Plus Purchase Tax 1/1

"RADSPORT" P.V.C. SPATTEES

C351/906 per pair 13/5
Plus Purchase Tax 6d.

JUPITER CAPES

Good quality oilskin. Black or Gold.
C459/1405 36" each 19/3
Plus Purchase Tax 8d.
C460/1506 39" each 20/8
Plus Purchase Tax 9d.
C461/1606 42" each 22/-
Plus Purchase Tax 10d.
C462/1802 45" each 24/3
Plus Purchase Tax 10d.



"STORM CHEETAH" CYCLE CAPES

In heavy embossed plastic satin finish. Colours: Gold, Black.
39". Gold and Black only.
C470/1103. Plus P.T. 6½d. ... each 16/11
42".
C471/1200. Plus P.T. 7d. ... each 18/-
45". Standard.
C472/1300. Plus P.T. 7½d. ... each 19/6
45". Oversize, extra large shoulders with 145" skirt.
C473/1400. Plus P.T. 8d. ... each 21/-
SOU'WESTER
C474/300. Plus P.T. 2d. ... each 4/6
CHEETAH PLASTIC "STAR" CAPES
Welded. Gold. 42".
C476/610 each 10/7
Plus Purchase Tax 4d.



"DUTTON" CAPES

Black or Gold Oilskin.
C467/1900 42" each 25/6
Plus Purchase Tax 11d.
C468/2006 45" each 27/6
Plus Purchase Tax 1/-



"RADSPORT" JACKET

Superb Styling
Size 34"/40". Black or Grey.
C465/4106 each 54/6
Plus Purchase Tax 2/-

THE "STORM CHEETAH" HANDICAPE

A very useful garment. Ideal for cyclists in traffic, in fact, anywhere you require a free arm movement: fishing, sailing, farm work, etc. The cape with sleeves. 45", extra strong sheeting. Gold and Black.
C478/1706 each 26/3
Plus Purchase Tax 9½d.



"RADSPORT" FAWN CAPE

42". Super Quality.
C480/1606 each 23/10
Plus Purchase Tax 8d.

45".
/1706 each 24/3
Plus Purchase Tax 9½d.

"RADSPORT" FAWN LEGGINGS

C481/1403 per pair 19/4
Plus Purchase Tax 7d.

JUPITER SOU'WESTERS

Good quality Oilskin. Black or Gold.
C486/309 each 4/11
Plus Purchase Tax 2d.

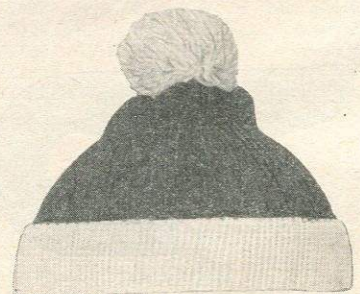

"RADSPORT" WOOLLEN BOBBY CAP

In two-tone colours.
C389/309 each 5/7
Plus Purchase Tax 2d.

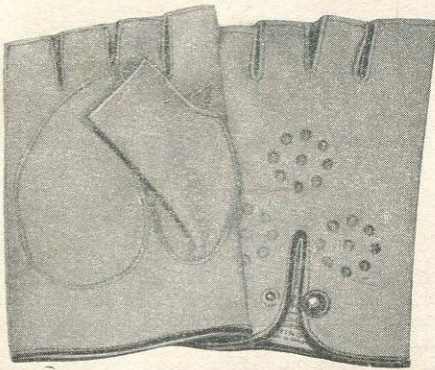

"RADSPORT" TRACK MITTS

Sizes: 8 to 10.

C490/804 per pair 12/6
Plus Purchase Tax 5d. per pair

TAN HIDE PALM GLOVES

C492/1106 Boys. P.T. 7d. per pair 16/6

C493/1206 Sizes: 9, 9½, 10 per pair 18/9
Plus Purchase Tax 7½d.

TAN HIDE GLOVES

Lambswool Lined

C494/2404 Sizes: 9, 9½, 10 per pair 36/6
Plus Purchase Tax 1/2

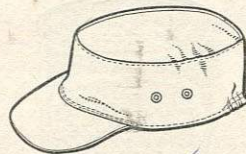

SKI CAPS

C499/111 each 2/11

Plus Purchase Tax 1d.

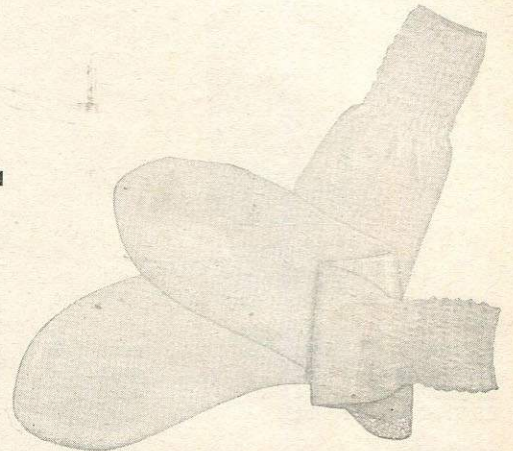

"RADSPORT" ANKLE SOCKS

Sizes: 9 to 11.

C512/1800 doz. pairs ... per pair 2/3
Plus Purchase Tax 1d. per pair

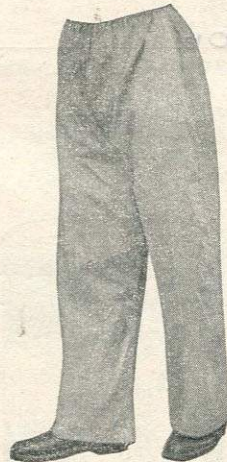

"RADSPORT" FAWN OVERTROUSERS

C500/1108 per pair 16/9

Plus Purchase Tax 6d.

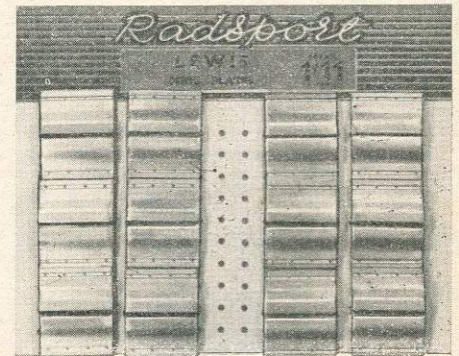

"RADSPORT" LEWIS SHOE PLATES

12 pairs per card.

C514/1504 per pair 1/11

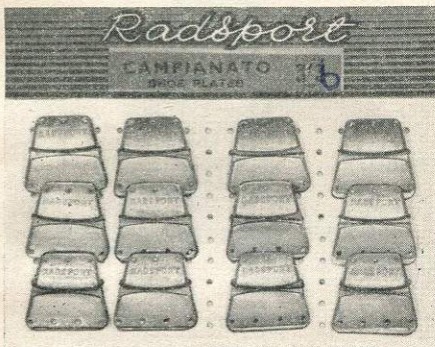

"RADSPORT" CAMPIANATO SHOE PLATES

12 pairs per card.

C496/2800 per pair 3/6

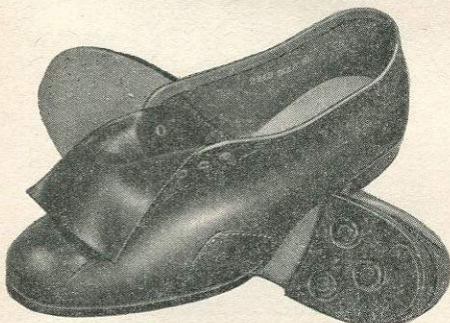

"RADSPORT" TOURING SHOES

Sizes: 6 to 11.

C478/2706 per pair 36/6
Plus Purchase Tax 1/3

JUPITER LEGGINGS

Good quality oilskin. Black or Gold.
Sizes: 28", 30" or 32".

C510/1209 per pair 16/11

Plus Purchase Tax 7d.

"DUTTON" LEGGINGS

Black or Gold Oilskin. Sizes: 28", 30" or 32".

C506/1309 per pair 20/6

Plus Purchase Tax 8d.

"STORM CHEETAH" LEGGINGS

To match capes. Sizes 32" only.

C508/711 per pair 12/-

Plus Purchase Tax 4d.



"RADSPORT" ASPIRANT TRACK SHOES

Sizes: 5 to 11.

C516/2606 per pair 35/6
Plus Purchase Tax 1/3

W. G. CHEESE LIMITED
CYCLE AND MOTOR ACCESSORIES, WIRELESS
AND ELECTRICAL SUNDRIES

JUPITER HOUSE
326-327, BRADFORD ST., BIRMINGHAM, 5
Telephone: MIDland 5804/5 (2 lines)



ROBBIALAC LACQUER

Synthetic finish. Black and in 20 different colours.

E5/1400 doz.	$\frac{1}{8}$ -pint	each 1/9
E6/2400 doz.	$\frac{1}{4}$ -pint	each 3/-
E7/4200 doz.	$\frac{1}{2}$ -pint	each 5/3
E8/7704 doz.	1-pint	each 9/8



JENOLITE RUST REMOVER

Small, 3-oz. size.

E9/104	each 2/-
--------	-----	-----	----------



HUMBROL ART OIL ENAMEL

A high quality enamel which is quick-drying with a smooth glossy porcelain finish. Assorted colours.

E10/504 doz.	$\frac{1}{2}$ -oz. tins	...	each 8d.
Gold, Bronze.	<i>2 MODIFIED ASSTD</i>		
E11/800 doz.	$\frac{1}{2}$ -oz. tins	...	each 1/-



LIMPET GOLD AND COPPER PAINT
E31/1600 doz. 2-oz. Jars ... each 2/-

LIMPET ALUMINIUM PAINT
E32/1200 doz. 2-oz. Jars ... each 1/6



SLICK CYLINDER BLACK

E13/1400 doz.	$\frac{1}{4}$ -pint	each 1/9
---------------	---------------------	-----	-----	----------

RADSPORT PAINT BRUSHES

E20/1200 doz.	$\frac{1}{2}$ "	...	each 1/6 1/8
E21/1304 doz.	$\frac{3}{4}$ "	...	each 1/8
E22/1800 doz.	1"	...	each 2/2
E23/2700 doz.	1 1/2"	...	each 3/4
E24/1706	12 assorted on card		

KANGAROO ENAMEL BRUSHES

24 per card.	$\frac{5}{8}$ "
E26/1400 card	each 10 1/2 d.

ARTIST BRUSHES

Supplied 36 on card.
E28/902 card	each 5d.



STARLINE ENAMELS

Available in Black and 24 different colours.

E46/102	$\frac{1}{2}$ -pint	...	each 1/9
E47/111	$\frac{1}{4}$ -pint	...	each 2/11

Other colours, Temple Gold, Temple Silver and Radiator Bronze.

E48/106	$\frac{1}{8}$ -pint	...	each 2/2
E49/206	$\frac{1}{4}$ -pint	...	each 3/8

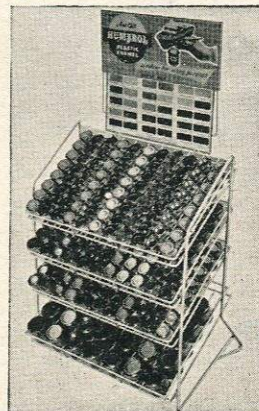

HUMBROL ART OIL ENAMEL DISPENSER
Supplied free on orders of 22 doz. $\frac{1}{2}$ -oz. tins and 35 2 1/2-oz. tins of Art Oil Enamel.
E12/Trade ... complete 152/4



CELLULOSE BRUSHING "BELCO"

Dries in one hour, dust free in 15 minutes. Available in following colours: Lawn Green, Dark Grey, Pale Blue, Brown, Light Green, Cream, Maroon, Light Grey, White, Jade Green, Dark Blue, Aluminium, also Black, etc.

E33/2304 doz.	$\frac{1}{4}$ -pint tins. Black	...	2/11
E33/2304 doz.	$\frac{1}{4}$ -pint tins. Colours	...	2/11
E34/304	$\frac{1}{2}$ -pint tins. Black	...	5/-
E35/304	$\frac{1}{2}$ -pint tins. Colours	...	5/-
E36/604	1-pint tins. Black	...	9/6
E37/200	$\frac{1}{2}$ -pint tins. Thinners	...	3/-
E38/308	1-pint tins. Thinners	...	5/6
E39/108	$\frac{1}{2}$ -pint Undercoat	...	2/6
E40/210	1-pint Undercoat	...	4/3
E41/2100 doz.	Primer Surfacer	...	2/7



LIMPET TRANSFER VARNISH

E30/504 doz.	$\frac{1}{2}$ -oz. Jars	...	each 8d.
--------------	-------------------------	-----	----------

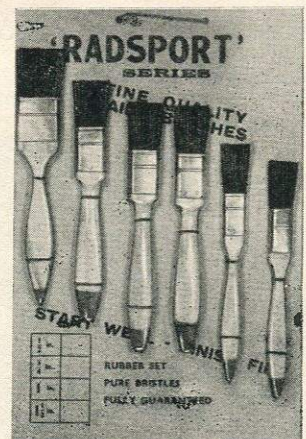

"RADSPORT" PAINT BRUSHES

$\frac{1}{2}$ "	12 per card.
R21/1302 per card	each 1/8
$\frac{3}{4}$ " 1" and 1 1/2"	12 per card, assorted.
R22/1906 per card	each



BW BOTTOM BRACKET AXLES
Shouldered Type. Chromium-plated finish.
F83/2502 doz. 1 1/2" Chain Line each 3/2
F84/2605 doz. 1 3/4" Chain Line each 3/4



BW BOTTOM BRACKET CUPS
No. 1. Standard Peg-hole Pattern.
F77/1003 doz. Chrome finish ... each 1/3 1/2
No. 2. Deep Peg-hole Pattern.
F79/1008 doz. Chrome finish ... each 1/4

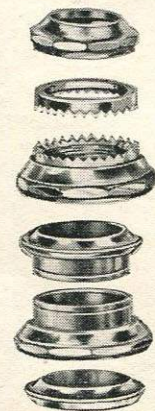

BRAMPTON ALALUT HEAD SET
No. 280. 1 1/4" x 20G. Head tube, 1" x 24 T.P.I. 5/32" balls. ... per set 9/6
F76/604 per set 9/6
No. 300. 1 1/4" x 22G. Head tube, 1" x 24 T.P.I. 5/32" balls. ... per set 9/6
F77/604 per set 9/6

CHATER LEA BOTTOM BRACKET AXLES

1/4" or 5/32" Balls.
No. 1640, 1615, 1007.
F91/300 308 ... each 4/6 9/6
All other Numbers
F92/304 400 ... Each 5/- 6/-



CHATER LEA BOTTOM BRACKET CUPS AND LOCK RINGS

1/4" or 5/16" Balls.
F93/202 R.H. Cups 206 ... each 3/3 3/4
F94/202 L.H. Cups 206 ... each 3/3 3/4
F95/1408 doz. Lock Rings ... each 1/40 2/-
1600

BW BOTTOM BRACKET CUPS

No. 8. Flanged Milled Pattern, screwed left-hand thread.
F83/1206 doz. Chrome finish each 1/6 1/2
No. 7. As above but shallow.
F84/1011 doz. C.P. ... each 1/4 1/2

BOTTOM BRACKET AXLES TO SUIT RALEIGH CYCLES

Best quality. Chrome finish.
Pattern A8. R16/8.
F97/200 201 ... each 3/1 1/2
Pattern A16. R16/10.
F98/200 201 ... each 3/1 1/2
Pattern A16. R16/11.
F99/200 201 ... each 3/1 1/2



BW FEATHERWEIGHT RACING AXLE
No. 15R. Made from a high tensile steel forging, drilled and counter bored.
F74/408 Chromium-plated finish each 7/-

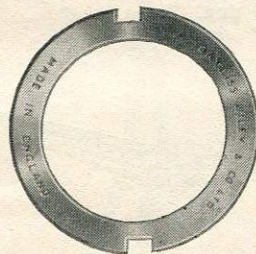

BW BRACKET LOCKING RINGS

No. 9. For Cotterless Bracket, milled.
F85/608 doz. Chrome finish ... each 10d.

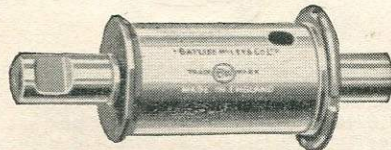

BW BRACKET AXLE UNIT

Consists of bracket axle, cups and bearings—already precision assembled—hermetically sealed, ready to slip into the frame.
F81/607 1 1/2" C.L. Chrome each 9/10
F82/608 1 3/4" C.L. Chrome each 10/-

BW FEATHERWEIGHT RACING BRACKET SET

No. 14/15/16. When used in conjunction with the BW No. 23R Featherweight Racing Bracket Axle, this bottom bracket set makes an ideal combination.
F80/409 ... per set 7/2



PHILLIPS HEAD LOCK NUTS

No. N3203. Standard 1/8" ball bearings.
F52/Trade ... per doz. 7/4
No. N3206. Carrier 5/32" ball bearings.
F53/Trade ... per doz. 7/8
No. N3203. Low gravity carrier, 3/16" ball bearings.
F54/Trade ... per doz. 7/4
No. N2802. Kiddies. 1/8" ball bearings.
F55/Trade ... per doz. 7/4

R 116

W. G. CHEESE LIMITED
CYCLE AND MOTOR ACCESSORIES, WIRELESS AND ELECTRICAL SUNDRIES

JUPITER HOUSE
326-327, BRADFORD ST., BIRMINGHAM, 5
Telephone: MIDland 5804/5 (2 lines)



PHILLIPS EXPANDER SCREW RACE

- No. F422. Standard. $\frac{1}{8}$ " ball bearings.
- F59/Trade per doz. 7/3
- No. F423. Carrier. $\frac{5}{32}$ " ball bearings.
- F60/Trade per doz. 10/8
- No. F413. Low gravity carrier. $\frac{3}{16}$ " ball bearings.
- F61/Trade per doz. 9/-
- No. F410. Kiddies. $\frac{1}{8}$ " ball bearings.
- F62/Trade per doz. 7/3



PHILLIPS TOP BALL RACE

- No. F401. Standard. $\frac{1}{8}$ " ball bearings.
- F63/Trade per doz. 3/1
- No. F405. Carrier. $\frac{5}{32}$ " ball bearings.
- F64/Trade per doz. 7/8
- No. F411. Low gravity carrier. $\frac{3}{16}$ " bearings.
- F65/Trade per doz. 5/3
- No. F408. Kiddies. $\frac{1}{8}$ " ball bearings.
- F66/Trade per doz. 3/1



PHILLIPS CROWN RACES

- No. F402. Standard. $\frac{1}{8}$ " ball bearings.
- F70/Trade per doz. 3/11
- No. F407. Carrier. $\frac{5}{32}$ " ball bearings.
- F71/Trade per doz. 4/4
- No. F412. Low gravity carrier. $\frac{3}{16}$ " bearings.
- F72/Trade per doz. 6/4
- No. F409. Kiddies. $\frac{1}{8}$ " ball bearings.
- F73/Trade per doz. 3/11

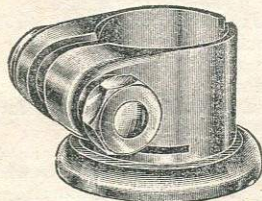

BRAMPTON BALL HEAD CLIPS

- AHC157. $\frac{3}{16}$ " dia. pressed for $\frac{1}{8}$ " balls.
- F67/304 Chromium Plated each 5/-
- AHC158. 1" dia. pressed for $\frac{1}{8}$ " balls.
- F68/304 Chromium Plated each 5/-
- AHC600. 1" dia. pressed for Cup and Cone Continental Head set $\frac{5}{32}$ " balls.
- F69/400 Chromium Plated each 6/-



PHILLIPS HUB LOCK NUTS

- N1002. All Hubs with $\frac{5}{16}$ " spindle.
- F132/Trade per gross 10/4
- N1203. All Hubs with $\frac{3}{8}$ " spindle.
- F138/Trade per gross 10/4



CYCLO CONVERSION SPINDLES

- For use when extra spindle length is required.
- No. 60. Complete Spindle. Standard size: $\frac{3}{8}$ " x 26 thread. Length $6\frac{1}{2}$ ".
 - F115/206 each 3/9
 - No. 61. Spindle with Cones only.
 - F116/109 each 2/6
 - F117/8. Long Cones each 11d.
 - F118/8. Spindle only each 11d.
 - No. 62R. Spindle and threaded packing pieces only, made for Raleigh cycles. Length 7". $\frac{5}{16}$ " x 26 thread.
 - F119/109 each 2/6

- B.H. "RACELITE" SPINDLES**
- F146/104 Front, complete each 2/-
 - F147/107 Rear, complete each 2/6

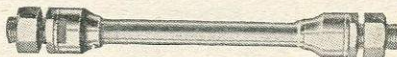

- BW HUB SPINDLES AND CONES**
- Shouldered type. In all standard sizes for front and rear hubs, with cones and nuts.
- F121/109 Standard. Front each 2/8
 - F122/110 Standard. Rear each 2/10
 - F123/200 Racing. Front, fitted with nuts each 3/-
 - F124/201 Racing. Rear, fitted with nuts each 3/2
 - F125/201 Continental. Front each 3/2
 - F126/205 Continental. Rear each 3/8
 - F127/208 Continental, for Derailleur Gear each 4/-

- No. 310 REAR DERAILLEUR SPINDLE**
- F154/204 each 3/6

JUPITER STANDARD HUB SPINDLES

- F128/1000 doz. Front each 1/3
- F129/1009 doz. Rear each 1/4

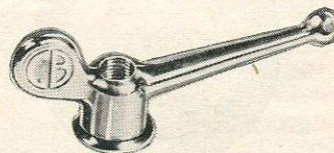

- G.B. ALLOY WING NUTS**
- F105/300. Front per pair 4/6
 - F106/300. Rear per pair 4/6



- B.W. HUB CONES**
- F150/409 doz. Standard Front each 7d.
 - F151/503 doz. Standard Rear each 8d.
 - F152/706 doz. Continental Front each 11d.
 - F153/803 doz. Continental Rear each 1/0 $\frac{1}{2}$

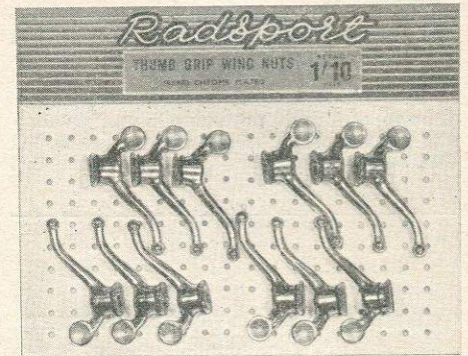

"RADSPORT" THUMB GRIP WING NUTS

- Front. 12 per card.
- F140/704 card each 11d.
- Rear. 12 per card.
- F141/704 card each 11d.

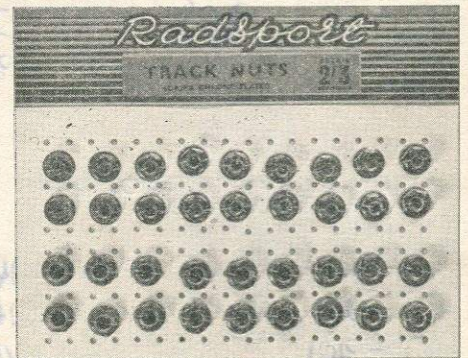

"RADSPORT" TRACK NUTS
Finest quality

- Front. 36 per card.
- F143/1306 card set of four 2/3
- Rear. 36 per card.
- F144/1306 card set of four 2/3
- Assorted. 36 per card.
- F145/1306 card set of four 2/3

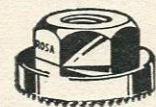

CYCLO "ROSA" TRACK NUTS

- No. 61. For Hub Spindles. Set of four.
- F110/104 Cadmium per set 2/-
- F111/108 Chrome per set 2/5

RESILION SPINDLES

- F155/103 Front each 1/11
- F156/204 Rear each 3/6

RESILION CONES

- F158/1206 doz. pairs per pair 1/6

Y Y 43

W. G. CHEESE LIMITED
CYCLE AND MOTOR ACCESSORIES, WIRELESS
AND ELECTRICAL SUNDRIES

JUPITER HOUSE
326-327, BRADFORD ST., BIRMINGHAM, 5
Telephone: MIDland 5804/5 (2 lines)

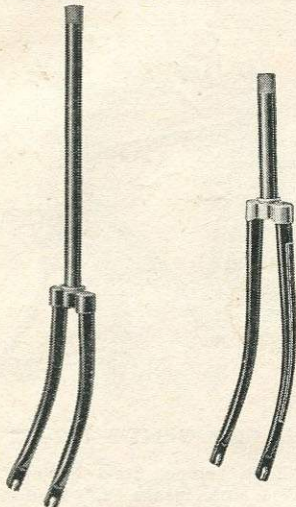

No. 256

No. 265

PHILLIPS FRONT FORKS Carrier Pattern

No. 265. Suitable for 26" equal wheel carrier bicycles. Screwed 1" x 24T for Expander Head fittings. Heavy gauge column and blades, with Crown Race fitted.
F170/1505 each 23/2

PHILLIPS FRONT FORKS Low Gravity Carrier Pattern

No. 256. Malleable Crown, heavy gauge column and blades with Crown Race fitted. Suitable for 20" wheels, screwed 1" x 24T for Expander Head fittings.
F171/1704 each 26/-

WEBB SPRING FORK For Motor-assisted Cycles

Improves the comfort, performance, and reliability of all types of motorised bicycles. Suitable for 26" wheels, with up to 2" tyres and all normal frame sizes. Accommodates existing Caliper or Hub Brakes. Replacement brake available for roller lever brakes on Westwood rims.

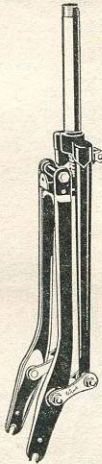

No. 842B. Standard Model. Black finish.

F174/5405 each 75/-

No. 842S. Standard Model. Silver finish.

F175/5405 each 75/-

No. 926B/S. Special for Raleigh Industries Bicycles. Black or Silver.

F176/5405 each 75/-

No. 1024B. Long column. Black finish.

F177/5405 each 75/-

No. 300. Standard Caliper Brake for use with above.

F178/706 each 11/3

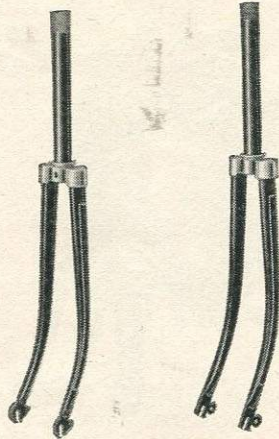

No. 273

No. 212

PHILRACE FRONT FORKS

No. 273. With chrome-plated Crown cover and Crown Race fitted. Supplied suitable for 26" and 27" wheels. Screwed 1" x 24T for Expander Head fittings. Drilled for Cable Brakes if required.

F180/1204 each 18/6

VOX POPULI FRONT FORKS

No. 212. With chrome-plated Crown Cover and Crown Race fitted. Solid machined fork ends with mudguard eyes. Screwed 1" x 24T for Expander Head fittings. Supplied suitable for 26" and 27" wheels.

F182/1308 each 20/6



No. 266

KIDDIES' FORKS

No. 266. Suitable for 14", 16", 18" and 20" wheels, with malleable crown and crown race fitted, screwed 7/8" x 24T for expander fittings.

F183/1001 each 15/2

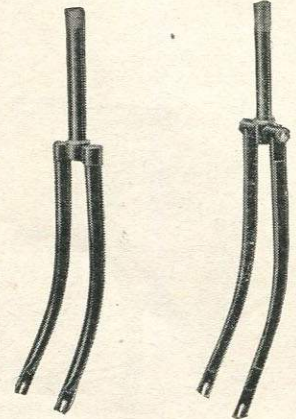

No. 213

No. 203

PHILCO FRONT FORKS

No. 213. Suitable for 20", 22", 24", 26" or 28" wheels, with Crown Race fitted. Screwed 1" x 24T for Expander Head fittings.

F184/1010 each 16/3

PHILLIPS ROADSTER FRONT FORKS

Tubular Pattern

No. 203. With chrome cups and Crown Race fitted. Screwed 1" x 24T for Expander Head fittings. Supplied suitable for 26" and 28" wheels.

F186/1508 each 23/6

HADEN CONTINENTAL FORKS

For 26"/27" wheels. Universal fitting, long screwed, column 9" x 3 1/2" x 1" dia. x 24 T.P.I. **HRF3.** All chromium.

F187/3000 each 45/-

HRF4. Silver enamel. Chromium-plated cover extra.

F188/2000 each 30/-



When ordering Front Forks please state size of wheels for which they are required and length of stem measured from top of crown; also whether the stems are required screwed 1" or 3/8" down. Head fittings are not supplied with forks unless ordered. If the forks are required lined, the lining desired should be specified and will be charged extra.

L 75

W. G. CHEESE LIMITED
 CYCLE AND MOTOR ACCESSORIES, WIRELESS
 AND ELECTRICAL SUNDRIES

JUPITER HOUSE
 326-327, BRADFORD ST., BIRMINGHAM, 5
 Telephone: MIDland 5804/5 (2 lines)

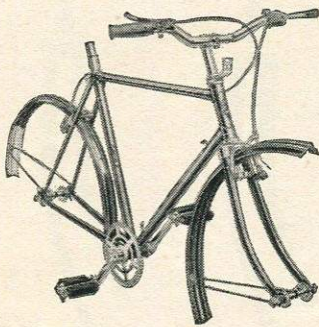

"PHILRACE" GENT'S FRAME

Built with True Temper Steel Tubing and Feature cut lugs, entirely brazed up. Straight tapered Chain Stays. Straight Round Seat Stays. Detachable Ball Race Seatings at top and bottom Head Lugs. Quick release Fork Ends. Chain Wheel with forged Cranks (1 1/2" Chainline, 1/2" x 1/8" Pitch). Straight Pattern Seat Pillar. Expander Head Fitting with Head Fitting Lamp Bracket. Plated Crown Cover. Special ribbed racing pattern Mudguards 25G with Plate Fastening Stays and white panel at rear. Standard finish: Black enamel, with single gold lining on "Bonderized" rust-proofed surface, usual bright parts chromium plated.

F206/9302 each £6 4 3
Available in colours at an extra 6/7 Trade

Sizes Available			
"Philrace" Ladies' and Gent's Frames			
20"	26"	46T	6 1/2"
21"	26"	46T	6 1/2"
22"	26"	46T	6 1/2"
23"	26"	46T	6 1/2"
24"	26"	46T	6 1/2"

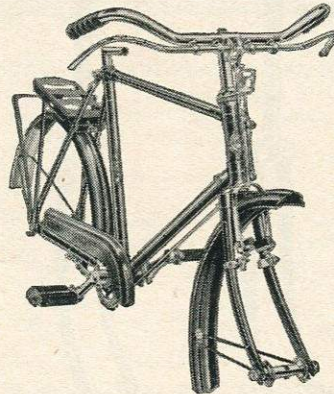

"PHILCO" KIDDIES' FRAMES

Built with True Temper Steel Tubing 3/4" x 7/8". D Section Fork Blades and Chain Stays. Round Seat Stays. Forward pattern Seat Pillar. Brazed-on Pump Pegs. Expander Head Fittings with Head Fitting Lamp Bracket. Mudguards 25G with Plate fastening Stays. Standard finish: Black enamel with single gold lining on "Bonderized" rust-proofed surface. Usual bright parts chromium plated.

Sizes Available

Frame	For Wheels	Chain Wheel	Cranks	
15"	16"	28T	4"	
16"	18"	28T	4"	
18"	20"	32T	4 1/2"	
F208/7305	Boys'	...	each	£4 17 11
F209/7603	Girls'	...	each	£5 1 8

VILLIERS FREEWHEEL REMOVER

Made of hardened steel.
F217/200 each 3/-



"PHILCO" GENT'S FRAME

Built with True Temper Steel Tubing. D to round section Fork Blades "D" Section Seat and Chain Stays. Chainwheel with forged Cranks (1 1/2" Chainline, 1/2" x 1/8" Pitch Chain). Straight pattern Seat Pillar. Expander Head Fittings with Head Fitting Lamp Bracket. Detachable Ball Race Seatings at top and bottom Head Lugs. Plated Crown Cover. Brazed on Pump Pegs. Special pattern Mudguards, 24-Gauge deep domed section with Plate Fastening Stays, white panel on rear. Standard finish: Black enamel with double gold lining on "Bonderized" rust-proofed surface, usual bright parts chromium plated.

F214/8706 each £5 16 8

Sizes Available

"Philco" Ladies' and Gent's Frame			
Frame	For Wheels	Chain Wheel	Cranks
16"	20"	32T	4 1/2"
16"	24"	40T	5 1/2"
18"	24"	40T	5 1/2"
20"	26" or 28"	44T	6 1/2"
22"	26" or 28"	46T	6 1/2"
24"	26" or 28"	46T	6 1/2"

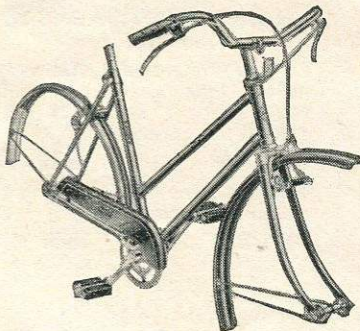

"PHILRACE" LADIES' FRAME

Specification as "Philrace" Gent's Frame.
F210/9603 each £6 8 4



"PHILCO" LADIES' FRAME

Specification as "Philco" Gent's Frame.
F212/9008 each £6 0 11

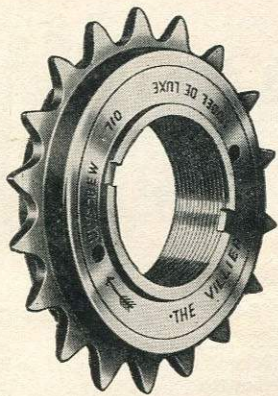

VILLIERS "MODEL DE LUXE" FREEWHEELS

$\frac{1}{2}$ " Pitch. With Separators

F300/411 $\frac{1}{2}$	18T $\times \frac{1}{8}$ " wide	...	each 7/4
F301/500 $\frac{1}{2}$	18T $\times \frac{3}{16}$ " wide	...	each 7/6
F302/500 $\frac{1}{2}$	19T and 20T $\times \frac{1}{8}$ " wide	...	each 7/6
F303/501 $\frac{1}{2}$	19T and 20T $\times \frac{3}{16}$ " wide	...	each 7/8
F304/505 $\frac{1}{2}$	22T $\times \frac{1}{8}$ " or $\frac{3}{16}$ " wide	...	each 8/2

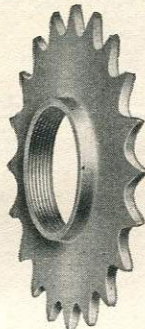

VILLIERS HUB SPROCKETS

Available in offset and central patterns and for Coaster Hubs. Bore screwed $1\frac{3}{8}$ ". Sizes from 12T. to 16T. incl. $\times \frac{1}{2}$ " Pitch.

F305/105 $\frac{1}{2}$	each 2/2
Sizes from 17T. to 22T. incl. $\times \frac{1}{2}$ " Pitch.			
F306/107 $\frac{1}{2}$	each 2/4

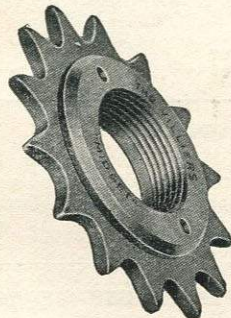

VILLIERS MIDGET FREEWHEELS

For Juvenile Bicycles 14T. $\times \frac{1}{8}$ " wide. $\frac{1}{2}$ " pitch.

F307/301 $\frac{1}{2}$	each 4/8
------------------------	-----	-----	----------

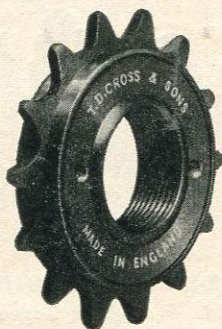

T.D.C. BALL BEARING MINIATURE FREEWHEELS

To suit Standard Miniature Hubs.
 No. F10B. 14T. $\times \frac{1}{2}$ " P. for $\frac{1}{8}$ " wide chains.
 F309/402 each 6/3

T.D.C. DE LUXE FREEWHEELS

No. A10A for $\frac{1}{8}$ " wide chain.

F310/500	18T. $\times \frac{1}{2}$ " Pitch	...	each 7/6
F311/500	16T., 17T., 19T. and 20T. $\times \frac{1}{2}$ " P.	...	each 7/6
F312/506	22T. $\times \frac{1}{2}$ " P.	...	each 8/3
F313/602	24T. $\times \frac{1}{2}$ " P.	...	each 9/3
F314/606	26T. $\times \frac{1}{2}$ " P.	...	each 9/9

No. A10B for $\frac{3}{16}$ " wide chain.

F315/500	18T. $\times \frac{1}{2}$ " P.	...	each 7/6
F316/502	16T., 17T., 19T and 20T. $\times \frac{1}{2}$ " P.	...	each 7/9
F317/506	22T. $\times \frac{1}{2}$ " P.	...	each 8/3
F318/602	24T. $\times \frac{1}{2}$ " P.	...	each 9/3
F319/606	26T. $\times \frac{1}{2}$ " P.	...	each 9/9

T.D.C. FREEWHEEL

F320/510	18T., $\frac{1}{2}$ " $\times \frac{3}{32}$ "	...	each 8/2
----------	---	-----	----------

T.D.C. MULTIPLE FREEWHEELS

3-Speed, Boss Type.

No. A100. 14T., 17T., 20T. $\times \frac{1}{2}$ " pitch $\times \frac{1}{8}$ " wide.

F322/1104	each 17/-
-----------	-----	-----	-----------

3-Speed, Flush Type.

No. A50. 16T., 18T., 20T. $\times \frac{1}{2}$ " $\times \frac{1}{8}$ ".

F323/1000	each 15/-
-----------	-----	-----	-----------

4-Speed.

No. A150. 14T., 16T., 18T., 20T. $\times \frac{1}{2}$ " $\times \frac{1}{8}$ " or $\frac{3}{32}$ ".

F324/1108	each 17/6
-----------	-----	-----	-----------

5-Speed.

No. 150. 14T., 16T., 18T., 20T., 22T. $\times \frac{1}{2}$ " $\times \frac{3}{32}$ ".

F325/1308	each 20/6
-----------	-----	-----	-----------

T.D.C. HUB COGS

F326/200	$\frac{3}{32}$ ", 12T. to 22T.	...	Retail 3/-
----------	--------------------------------	-----	------------

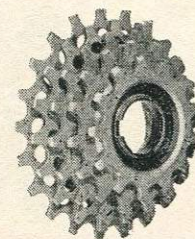

REGINA FREEWHEELS

Suitable for use with all gears, it is designed with flush back and narrow body.

5-speed. 13 Top, 15-16 2nd, 14-16 top, 15-18 2nd, 16-20 middle, 17-28 (no 27) bottom 2 cogs

F329/1404 each 21/6
 4-speed. (Can be converted into five by exchanging smallest cog for double cog.) Sizes as 5-speed.

F330/1204	each 18/6
Bodies only, Standard and for 13 tooth top.			
F332/404	each 6/6
Spare Sprockets 13 to 28 (no 27).			
F333/200	each 3/-

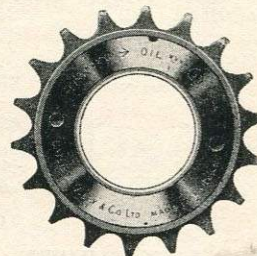

B.W. FREEWHEELS

F335/411 $\frac{1}{2}$	18T. $\times \frac{1}{8}$ " wide $\times \frac{1}{2}$ " P.	...	each 7/4
F336/500 $\frac{1}{2}$	18T. $\times \frac{3}{16}$ " wide $\times \frac{1}{2}$ " P.	...	each 7/6
F337/500 $\frac{1}{2}$	19T. $\times \frac{1}{8}$ " wide $\times \frac{1}{2}$ " P.	...	each 7/6
F338/500 $\frac{1}{2}$	20T. $\times \frac{1}{8}$ " wide $\times \frac{1}{2}$ " P.	...	each 7/6
F339/501 $\frac{1}{2}$	20T. $\times \frac{3}{16}$ " wide $\times \frac{1}{2}$ " P.	...	each 7/8
F340/301 $\frac{1}{2}$	14T. $\times \frac{1}{8}$ " wide $\times 1\frac{1}{2}$ " P.	...	each 4/8



B.W. SPROCKET LOCK RINGS

With machined key-way, perfectly concentric for use with all standard size sprockets.

F346/3604	per 100	...	each 6 $\frac{1}{2}$ /-
-----------	---------	-----	-------------------------

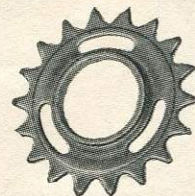

PERRY HUB SPROCKETS

F348/1100	doz. 14-15T	...	each 1/3
F349/1105	doz. 16-17T	...	each 1/4
F350/1205	doz. 18-19T	...	each 1/5
F351/1300	doz. 20T	...	each 1/6
F352/1310	doz. 21-22T	...	each 1/7

Y G 7

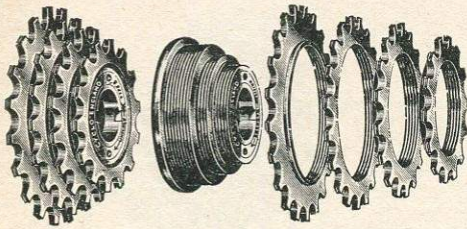

BENELUX FOUR-SPEED FREEWHEELS

Ref. BEFE. S.B. 4-speed, $\frac{3}{32}$ "	
First and Second ...	17 to 26T., 28T.
Third and Fourth ...	15 to 20T.
Top ...	13 to 16T.
Complete Freewheel.	
F441/1601 ...	each 24/2
Body only.	
F442/708 ...	each 11/6
Spare Sprockets.	
F243/201 13T to 20T	each 3/1
F244/201 21T to 23T	each 3/1
Ref. BEFA. B.2 4-speed $\frac{1}{8}$ "	
First and Second ...	17 to 26T, 28T.
Third and Fourth ...	15 to 19T.
Top ...	13 to 16T.
Complete Freewheel.	
F445/1609 ...	each 25/2
Body only.	
F446/805 ...	each 12/8
Spare Sprockets.	
F447/201 13T to 20T	each 3/1
F448/201 21T to 23T	each 3/1

BENELUX BUMPER

Ideal gear protector against fall of cycle.
 Ref. 583/R. Right side protector, $1\frac{1}{2}$ " long.
 G61/200 ... each 2/11
 Ref. 583/L. Left side to match, $\frac{3}{4}$ " long.
 G62/108 ... each 2/5
 Per Set.
 G63/306 ... per set 5/3

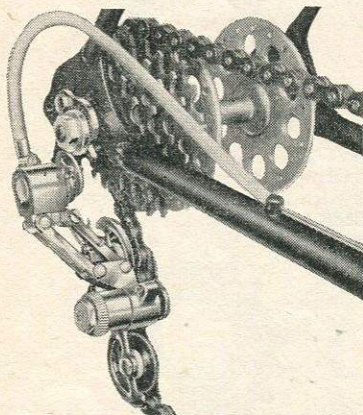

BENELUX "SUPER 60" GEAR

4-Speed, $\frac{3}{32}$ ". Freewheel sizes recommended
 14-16-19-23T.
 5-Speed, $\frac{3}{32}$ ". Freewheel sizes recommended
 14-16-19-21-25T.
 Less freewheel.
 G70/4608 ... each 70/-

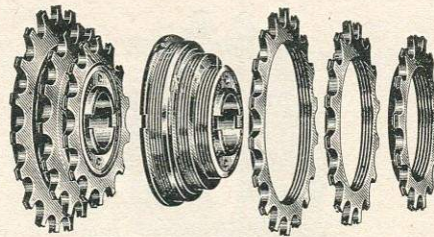

BENELUX THREE-SPEED FREEWHEELS

Ref. BLUSH. Flush Back 3-speed, $\frac{1}{8}$ ". For all types of standard hubs. Complete Freewheel.	
First ... 20T. Second ... 18T. Top ... 16T.	
F431/1400 ...	each 21/-
Body with top sprocket.	
F432/1006 ...	each 15/9
First Gear Sprocket.	
F433/204 ...	each 3/6
Second Gear Sprocket.	
F434/204 ...	each 3/6
Ref. BEF. S.B. 3-speed, $\frac{1}{8}$ ".	
First ... 17 to 26T, 28T.	
Second ... 15 to 17T.	
Third ... 13 to 16T.	
Complete Freewheel.	
F437/1400 ...	each 21/-
Body only.	
F438/708 ...	each 11/6

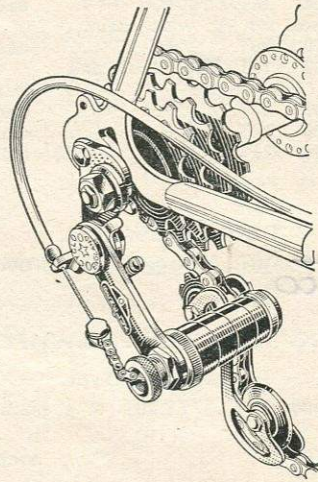

BENELUX MARK 7 GEAR

Available in four types: 3-speed for $\frac{1}{2}$ " x $\frac{1}{8}$ " chain, 4-speed for $\frac{1}{2}$ " x $\frac{1}{8}$ " or $\frac{1}{2}$ " x $\frac{3}{32}$ " chain, and 5-speed for $\frac{1}{2}$ " x $\frac{3}{32}$ " chain. Sprocket range 13T to 24T. With double chain wheel overall range 15T difference.
 Ref. BAYS. 3-speed x $\frac{1}{8}$ ". Standard ratio 14 x 17 x 20T.
 G50/3500 ... each 52/6
 Ref. BOBYS. 4-speed x $\frac{1}{8}$ ". Standard ratio 14 x 16 x 18 x 20T.
 G51/3709 ... each 56/8
 Ref. BABYS. 4-speed x $\frac{3}{32}$ ". Standard ratio 14 x 16 x 18 x 20T.
 G52/3701 ... each 55/8
 Ref. BROOMS. 5-speed x $\frac{3}{32}$ ". Standard ratio 14 x 16 x 18 x 20 x 22T.
 G53/3911 ... each 59/10

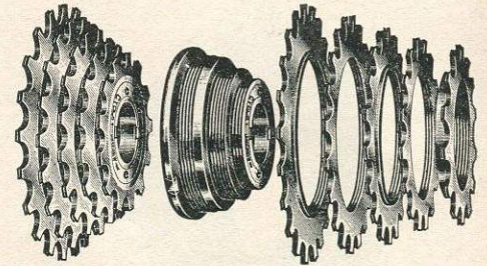

BENELUX FIVE-SPEED FREEWHEELS

Ref. BEFO. B.2. 5-speed, $\frac{3}{32}$ ".	
First and Second ...	17 to 26T, 28T.
Third and Fourth ...	15 to 20T.
Top ...	13 to 16T.
Complete Freewheel.	
F454/1811 ...	each 28/4

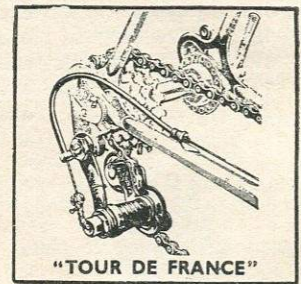

SIMPLEX GEARS

"Tour de France". Rear Derailleur gears. Consists of gear mechanism, control lever and transmission with nylon rollers. 3-speed for $\frac{1}{8}$ " chain, 4-speed for $\frac{3}{32}$ " chain.
 G71/2000 ... each 29/11
 4-speed for $\frac{1}{8}$ " chain, 5-speed for $\frac{3}{32}$ " chain.
 G72/2109 ... each 32/6

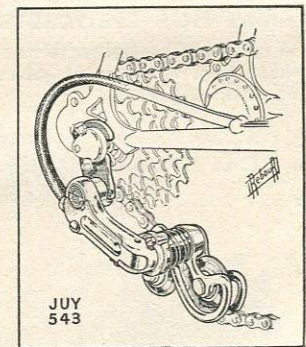

SIMPLEX GEARS

"JUY-543". Boxed set of rear Derailleur gears, consisting of gear mechanism, control lever and transmission. Speed selector.
 G85/5300 ... each 79/6

ALTENBURGER GEARS

G86/5000 Complete ...	each 75/-
G87/2508 Front ...	each 38/6
G88/3204 Rear ...	each 48/6

D 274

**BENELUX Mk. 7 GEAR SPARES
G176/K**

Ref. No.		Each
10M	Rear Guide Plate ...	3/8
12M	Front Guide Plate ...	2/4
22M	Small Spring Ret. Cup ...	6d.
24M	Adjustable Stop ...	8d.
24Ma	Adjustable Stop for Gear End ...	1/1
32M	Friction Spring ...	3d.
34M	Adjustable Stop Screw ...	3d.
42M	Op. Shaft ...	3/2
44M	Spring Loc. Cup ...	3d.
46M	Shaft Nut ...	3d.
48M	Pulley Pin ...	6d.
70M	Screwed Cone ...	2/1
72M	Tapped Cone ...	1/7
O.E.14	Gear Arm ...	5/3
O.E.18/58	Toggle Chain Assembly ...	2/1
O.E.54	Swivel Pin and Bush ...	2/-
O.E.60	Adj. Sleeve ...	3/8
O.E.62	Adj. Nut ...	4d.
B.5	Volute Spring ...	1/7
B.12a	Rosa Stop Guide and Pin ...	5d.
B.13	Taper Tension Spring ...	1/7
B.15	Nut ...	4d.
B.16	Large Spring Ret. Cup ...	6d.
B.29a	Draw Bolt Assembly ...	8d.
M.02	Arm Bracket ...	2/8
64c	Sprocket, Steel or Nylon ...	4/3
66c	Roller, Steel or Nylon ...	3/9

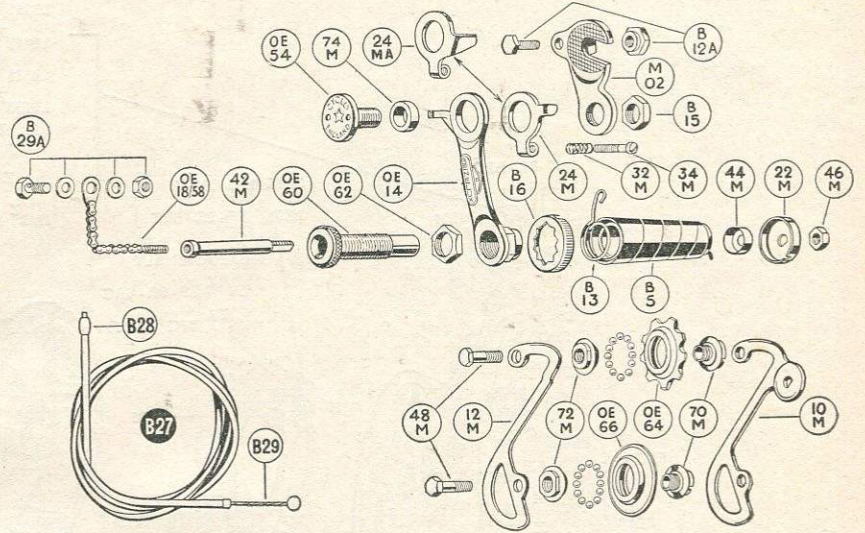

**BENELUX LEVER SPARES
G177/K**

Ref. No.		Each
B.27	Transmission ...	complete 3/2
B.28	Cable Bell Ferrule ...	2d.
B.29	Inner Wire ONLY ...	1/1
L.19	Lever Centre Screw ...	2d.
L.20	Spring Friction Plate ...	6d.
L.21	Large Washer ...	6d.
L.21a	Fibre Washer ...	2d.
L.22	Lever Banjo ...	3/2
L.24	Back Plate ...	9d.
L.24a	Cable Adjuster ...	4d.
L.25	Clip Complete with Boss ...	1/7
L.25a	Brazed on Type ...	1/1
L.26	Bolt and Nut for Clip ...	4d.

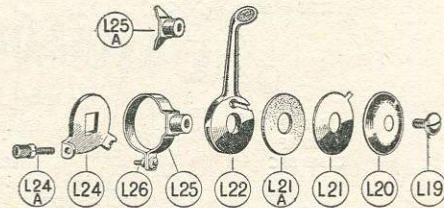

**BENELUX CABLE CONTROL CHAIN
SHIFTER SPARES
G178/K**

When ordering Shifter Cage, C.S.1, please state whether for $\frac{1}{8}$ " or $\frac{3}{32}$ " chain.

Ref. No.		Each
C.C.144	System Housing ...	17/6
C.C.145	Bell Crank ...	6d.
C.C.146	Operating Shaft ...	4/9
C.C.147	Spring ...	4d.
C.C.148	Tension Shaft ...	3/2
C.C.150	Adjusting Collar ...	6d.
C.C.151	Lock Nut ...	8d.
C.C.152	Shakeproof Nut ...	3d.
C.C.153	Draw Bolt Assembly ...	1/1
C.C.154	Rivet ...	1d.
C.C.155	System Clamp Screw ...	3d.
C.S.1	Shifter Cage Assembly ...	5/3
C.S.1A	Shifter Cage Lock Screw ...	3d.
C.S.4	System Half Clip ...	3/2

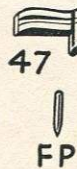
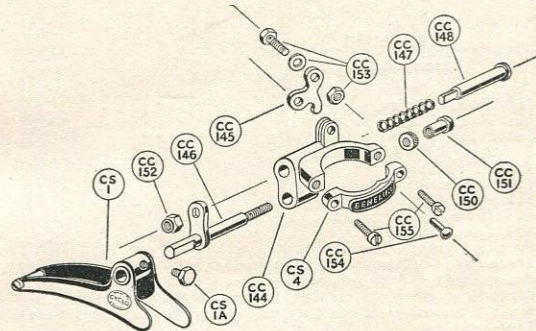

**Pawl 6d.
Spring Peg
1d.**



**Locking
Plate
1/7**

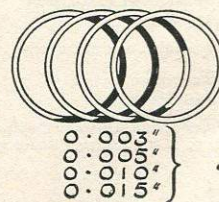

**Shim
Washer
1/7 per doz.**

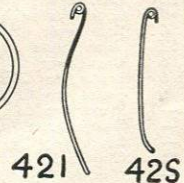

**Spring
Long
2 for 3d.**

**Spring
Short
2 for 3d.**

When ordering, please state reference number and whether for $\frac{1}{8}$ " or $\frac{3}{32}$ " chain.

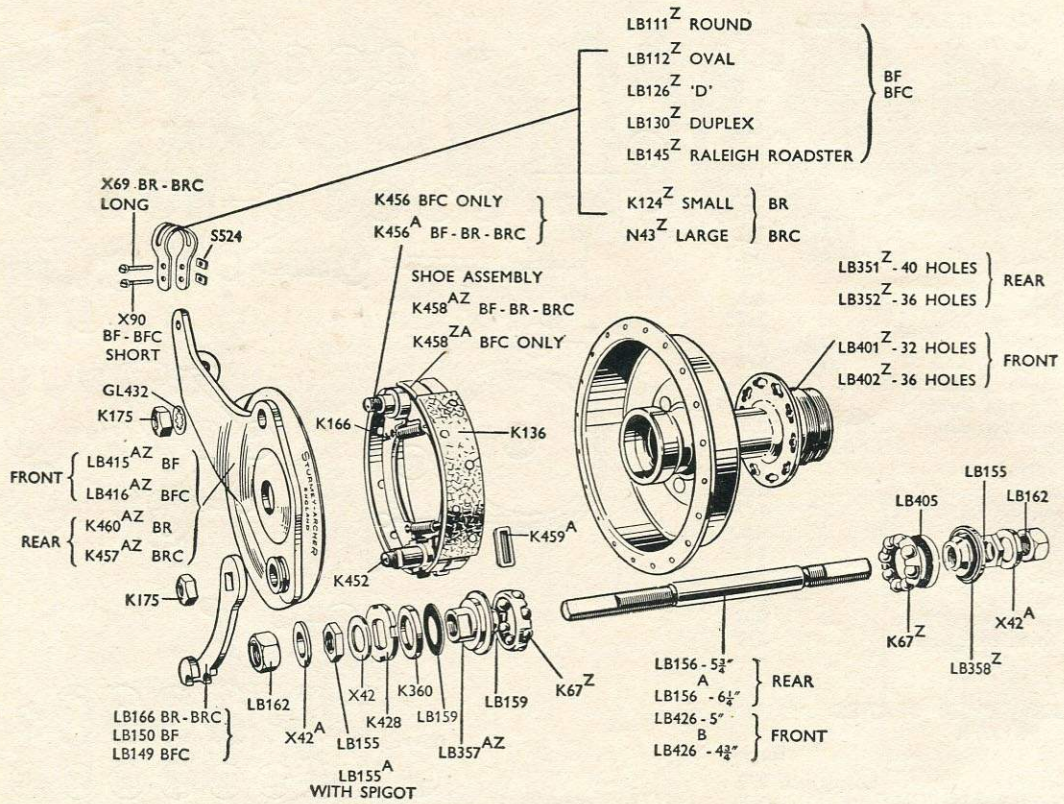

STURMEY-ARCHER B.F. AND B.R. INTERNAL EXPANDING BRAKE HUBS

For Prices see pages 41 and 42

BF HUB			BR HUB		
Code No.	Carton Quantity	Description	Code No.	Carton Quantity	Description
LB401Z	1	Hub Shell, 32 holes	LB155	24	Cone Locknut
LB402Z	1	Hub Shell, 36 holes	LB155A	24	Cone Locknut with spigot
M355	6	Lubricator	LB162	12	Axle Nut
K67Z	24	Ball Cage with 8 1/4" dia. balls			
LB405	12	Outer Dust Cap			
LB426	12	Spindle 5" long			
LB426B	12	Spindle 4 3/4" long			
LB358Z	12	R.H. Cone with Dust Cap			
LB357AZ	12	L.H. Cone with Dust Cap			
LB159	6	Packing Washer			
LB416AZ	—	Brake Plate and Arm for Cable operation			
LB415AZ	—	Brake Plate and Arm for Rod operation			
K458AZ	1	Brake Shoes complete less Cam, Pin type for Rod operation			
K458ZA	1	Brake Shoes complete less Cam, Sleeve type for Cable operation			
K459A	6	Shoe End Cap			
K136	6 prs.	Brake Linings (per pair with rivets)			
K456	—	Fulcrum Sleeve—for cable operation only			
K456A	—	Fulcrum Pin—for rod operation only			
K166	12	Brake Shoe Spring			
K452	3	Brake Operating Cam			
K175	24	Cam Lever Nut—also used with K456A			
GL432	6	Lock Washer—Rod operation only			
LB150	6	Cam Lever			
K171	12	Wire Guide			
LB149	6	Cam Lever			
LB111Z	6	Brake Arm Clip complete, round			
LB112Z	6	Brake Arm Clip complete, oval			
LB126Z	—	Brake Arm Clip complete, 'D'			
LB130Z	—	Brake Arm Clip complete, Humber Duplex			
LB145Z	—	Brake Arm Clip complete, Raleigh Roadster			
X90	12	Clip Screw			
S386	—	Clip Nut			
K360	12	Spacing Washer			
K428	12	Notched Cone Adjuster			
K42A	24	Axle Washer, 1/8" thick			
X42A	24	Axle Washer 1/8" thick			
X42	24	Axle Washer 1/8" thick			

W. G. CHEESE LIMITED
CYCLE AND MOTOR ACCESSORIES, WIRELESS
AND ELECTRICAL SUNDRIES

JUPITER HOUSE
326-327, BRADFORD ST., BIRMINGHAM, 5
Telephone: MIDland 5804/5 (2 lines)

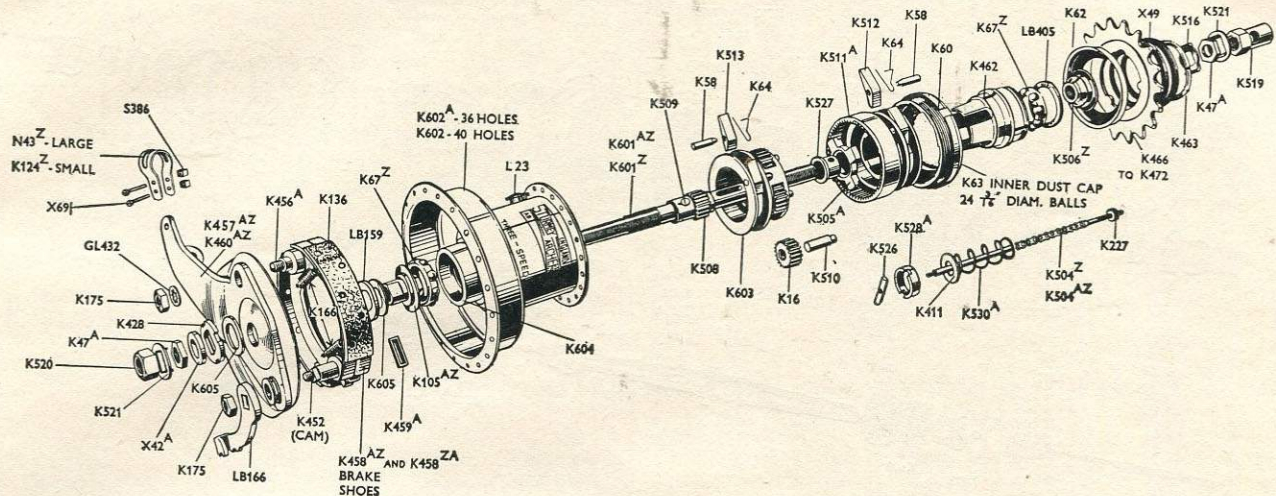

STURMEV-ARCHER A.B. 3-SPEED WIDE-RATIO HUB COMBINED WITH INTERNAL EXPANDING BRAKE

For Prices see pages 41 and 42

Code No.	Carton Quantity	Description	Code No.	Carton Quantity	Description
K601AZ	6	Axle complete with Sun Pinion, 6 1/4" long	K458ZA	1	Brake Shoe Assembly (Sleeve type) Less Cam, 1952/53 (Not illustrated)
K601Z	6	Axle with Sun Pinion, 5 3/4" long	K459A	6	Shoe End Cap
K508	12	Sun Pinion only	K136	6 prs.	Brake Linings with Rivets (per pair)
K509	24	Dowel for Sun Pinion	K456A	—	Fulcrum Pin
K603	2	Planet Cage	K166	12	Brake Shoe Spring
K527	6	Clutch Sleeve	K452	3	Cam
K505A	12	Sliding Clutch	K456	—	Fulcrum Sleeve, 1952/3 only (Not illustrated)
K526	24	Axle Key	GL432	6	Locking Washer
K528A	6	Thrust Ring	LB166	6	Cam Lever
K411	6	Thrust Washer	K175	24	Cam Lever Nut
K16	24	Planet Pinion	K504AZ	6	Indicator for long axle (K601AZ)
K510	24	Pinion Pin	K504Z	12	Indicator for short axle (K601Z)
K511A	4	Gear Ring	K227	24	Connection Locknut
K512	24	Gear Ring Pawl	K428	12	Notched Adjusting Washer
K64	24	Pawl Pin	X42A	24	Spacing Washer (1/8" thick)
K58	36	Pawl Spring	K47A	24	Cone Locknut
K60	3	R.H. Ball Ring	K521	24	Axle Washer
329	—	Ball Bearings 3/16" dia. (per set of 24)	K519	12	R.H. Axle Nut
K63	6	Inner Dust Cap	K520	24	L.H. Axle Nut
K530A	12	Clutch Spring	K62	12	Sprocket Dust Cap
K529	12	Clutch Spring Cap	K466	6	Sprocket, 16 teeth
K462	6	Driver	K467	6	Sprocket, 17 teeth
K67Z	24	Ball Cage with 1/4" dia. balls	K468	6	Sprocket, 18 teeth
LB405	12	Outer Dust Cap	K468A	6	Sprocket, 18 teeth for 3/16" wide chain
K506Z	12	R.H. Cone with dust cap	K469	6	Sprocket, 19 teeth
K516	24	Lock Washer for R.H. Cone	K469A	6	Sprocket, 19 teeth for 3/16" wide chain
K513	24	Low Gear Pawl	K470	6	Sprocket, 20 teeth
K602	1	Shell, 40 holes	K472	—	Sprocket, 22 teeth
K602A	1	Shell, 36 holes	X49	12	Sprocket Spacing Washer (1/16" thick)
L23	24	Lubricator	K463	6	Circlip
K604	3	L.H. Ball Cup	N43Z	6	Brake Arm Clip complete, for oval or D tubing
K105AZ	12	L.H. Cone with dust cap	K124Z	6	Brake Arm Clip complete for round tubing
LB159	6	Thin Packing Washer	X69	12	Clip Screw
K605	12	Packing Washer	S386	—	Clip Nut
K457AZ	3	Brake Arm			
K458AZ	1	Brake Shoe Assembly (Pin type) Less Cam, from 1954			

A 3 11

W. G. CHEESE LIMITED
 CYCLE AND MOTOR ACCESSORIES, WIRELESS
 AND ELECTRICAL SUNDRIES

JUPITER HOUSE
 326-327, BRADFORD ST., BIRMINGHAM, 5
 Telephone: MIDland 5804/5 (2 lines)

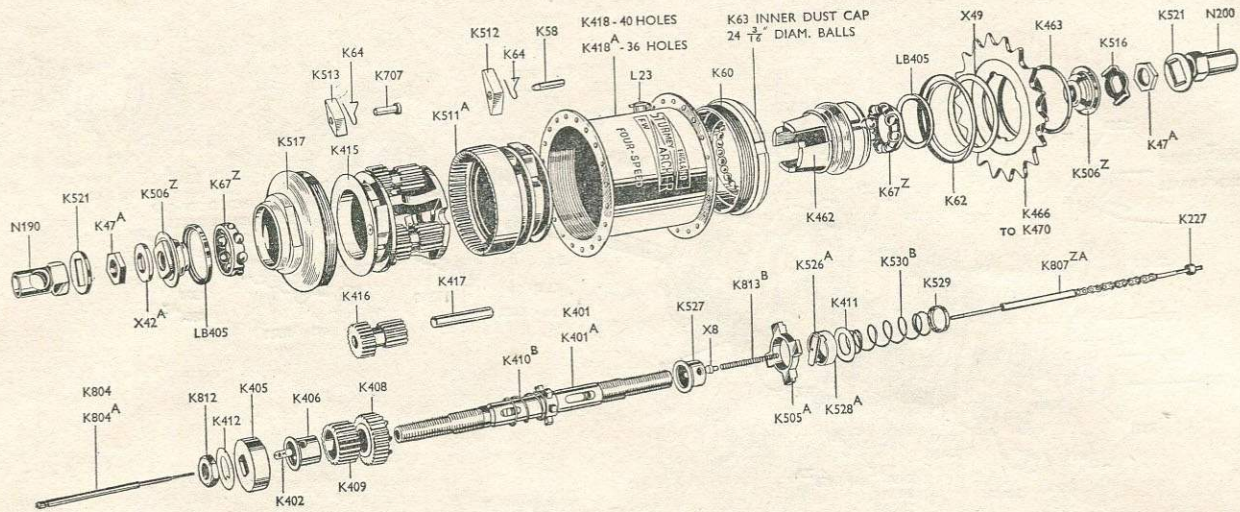

STURMEY-ARCHER F.W. WIDE RATIO 4-SPEED HUB

For Prices see pages 41 and 42

Code No.	Carton Quantity	Description	Code No.	Carton Quantity	Description
K401	6	Axle, 5 $\frac{3}{4}$ " long	K511A	4	Gear Ring
K401A	6	Axle, 6 $\frac{1}{4}$ " long	K512	24	Gear Ring Pawl
K410B	6 sets	Low Gear Spring (supplied with K813B and K530B)	K58	24	Pawl Pin
K408	12	Primary Sun Pinion	K60	3	R.H. Ball Ring
K409	12	Secondary Sun Pinion	329	—	Ball Bearings, $\frac{3}{16}$ " dia. (per set of 24)
K406	6	Pinion Sleeve	K63	6	Inner Dust Cap
K402	24	Low Gear Key	K462	6	Driver
K405	6	Dog Ring	K67Z	24	Ball Cage with 8 $\frac{1}{4}$ " balls
K412	12	Locking Washer	LB405	12	Outer Dust Cap
K812	6	Locknut	K506Z	12	Axle Cone with Dust Cap
K415	3	Planet Cage	K516	24	R.H. Cone Locking Washer
K513	24	Low Gear Pawl	K418	1	Shell, 40 holes
K707	12	Low Gear Pawl Pin	K418A	1	Shell, 36 holes
K64	36	Pawl Spring	L23	24	Lubricator
K416	12	Planet Pinion	K517	2	L.H. Ball Cup
K417	12	Pinion Pin	K411	6	Thrust Washer
K804	6	Indicator for short axle	X42A	24	Axle Spacing Washer ($\frac{1}{8}$ " thick)
K804A	6	Indicator for long axle	K47A	24	Cone Locknut
X8	12	Collar for Compensator Spring	K521	24	Axle Locking Washer
K813B	—	Compensator Spring (See K410B)	N190	12	L.H. Axle Nut
K527	6	Clutch Sleeve	N200	12	R.H. Axle Nut
K505A	12	Sliding Clutch	K62	12	Sprocket Dust Cap
K526A	24	Axle Key	K466	6	Sprocket, 16 teeth
K807ZA	6	Coupling complete	K467	6	Sprocket, 17 teeth
K227	24	Connection Locknut	K468	6	Sprocket, 18 teeth
K528A	6	Thrust Ring	K469	6	Sprocket, 19 teeth
K530B	—	Clutch Spring (See K410B)	K470	6	Sprocket, 20 teeth
K529	12	Spring Cap	X49	12	Sprocket Spacing Washer
			K463	6	Circlip

Y S 12

W. G. CHEESE LIMITED
CYCLE AND MOTOR ACCESSORIES, WIRELESS
AND ELECTRICAL SUNDRIES

JUPITER HOUSE
326-327, BRADFORD ST., BIRMINGHAM, 5
Telephone: MIDland 5804/5 (2 lines)

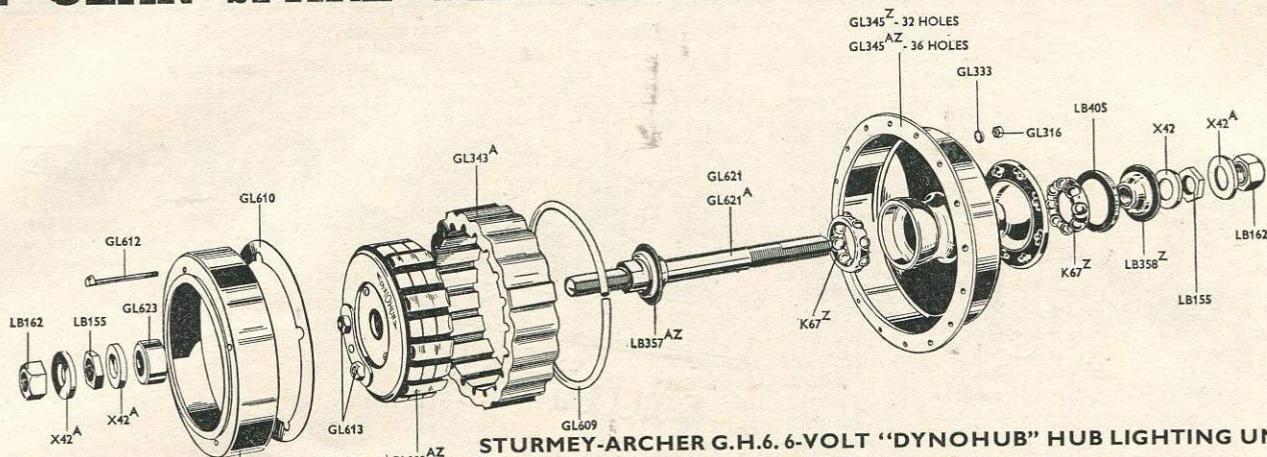

STURMEV-ARCHER G.H.6. 6-VOLT "DYNOHUB" HUB LIGHTING UNIT
For Prices see pages 41 and 42

Code No.	Carton Quantity	Description	Code No.	Carton Quantity	Description	Code No.	Carton Quantity	Description
GL345Z	1	Shell, 32 holes	GL343A	1	Magnet	GL623	4	Spacing Cup
GL345AZ	1	Shell, 36 holes	GL609	—	Magnet Spacing Ring	X42A	24	Axle Spacing Washer ($\frac{1}{8}$ " thick)
M355	6	Lubricator	GL610	—	Patent Number Disc	X42	24	Axle Spacing Washer ($\frac{1}{16}$ " thick)
LB405	12	Dust Cap	GL611	2	Magnet Cover Plate	LB155	24	Cone Locknut
K67Z	24	Ball Cage with 8 $\frac{1}{4}$ " dia. balls	GL612	12	Magnet Fixing Screw	LB155A	24	Cone Locknut with spigot. Not illustrated.
GL621	12	Spindle, 5" long	GL316	72	Nut for Magnet Fixing Screw	LB162	12	Axle Nut
GL621A	12	Spindle, 4 $\frac{3}{4}$ " long	GL333	36	Lock Washer			
LB358Z	12	R.H. Cone with Dust Cap						
LB357AZ	12	L.H. Cone with Dust Cap						
GL603AZ	1	Armature complete						
GL613	12	Terminal Nut						

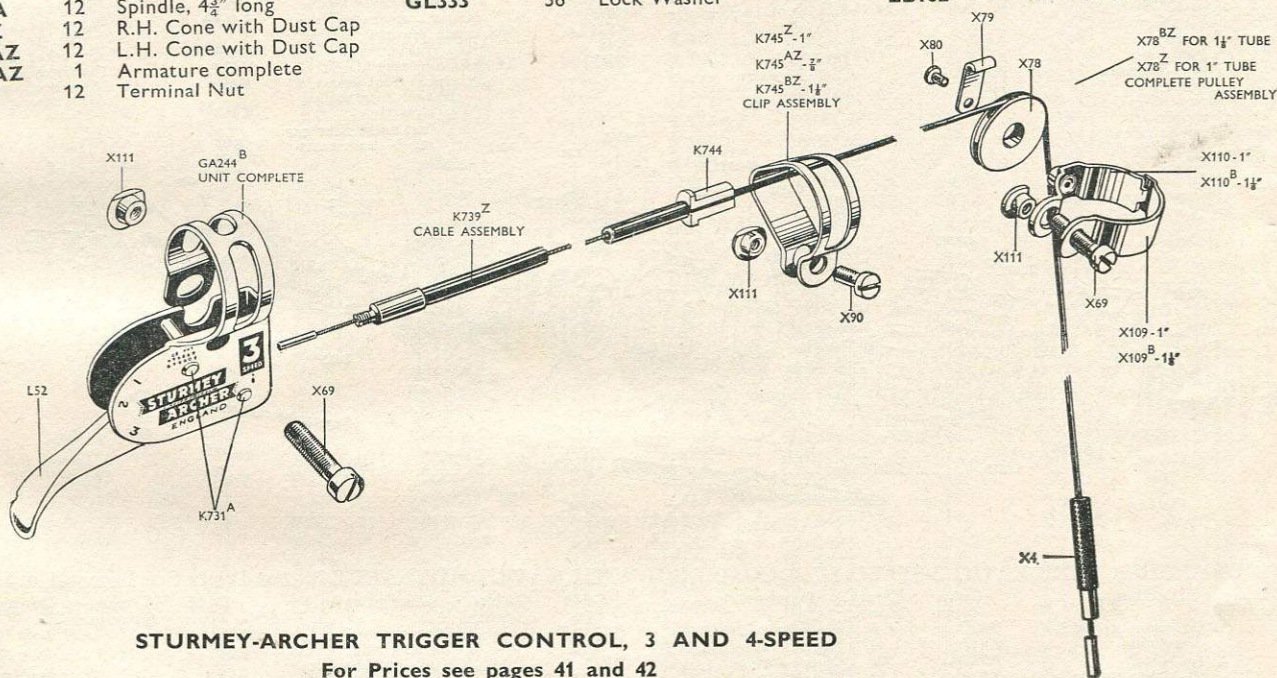

STURMEV-ARCHER TRIGGER CONTROL, 3 AND 4-SPEED
For Prices see pages 41 and 42

Code No.	Code No.	Carton Quantity	Description	Code No.	Carton Quantity	Description
3-Speed Unit	4-Speed Unit					
GC3B	GC4A	1	Trigger Control complete less pulley	K745Z	6	Fulcrum Clip complete, 1" diameter
GA244B	GA246A	6	Trigger Unit	K745AZ	6	Fulcrum Clip complete, $\frac{7}{8}$ " diameter
L52	K723	1	Trigger Lever	K745BZ	6	Fulcrum Clip complete, $1\frac{1}{8}$ " diameter
K731A	K731A	12	Pivot Pin	X90	12	Clip Screw
L55	K722	6	Trigger Pawl	X78Z	6	Pulley complete for 1" tube
L56	K738	12	Trigger Spring	X78BZ	6	Pulley complete for $1\frac{1}{8}$ " tube
X69	X69	12	Clip Screw	X69	12	Clip Screw
X111A	X111A	12	Clip Screw Nut	X78	6	Pulley Wheel only
K739Z		6	Trigger Cable assembly—Give length of both inner wire and outer cable	X79	12	Pulley Arm
K744		12	Fulcrum Sleeve	X80	12	Pulley Arm Screw
				X110BZ	6	Clip with Pulley Stud ($1\frac{1}{8}$ " tube)
				X109B	6	Half-clip ($1\frac{1}{8}$ " tube)

R 113

W. G. CHEESE LIMITED
CYCLE AND MOTOR ACCESSORIES, WIRELESS
AND ELECTRICAL SUNDRIES

JUPITER HOUSE
326-327, BRADFORD ST., BIRMINGHAM, 5
Telephone: MIDland 5804/5 (2 lines)

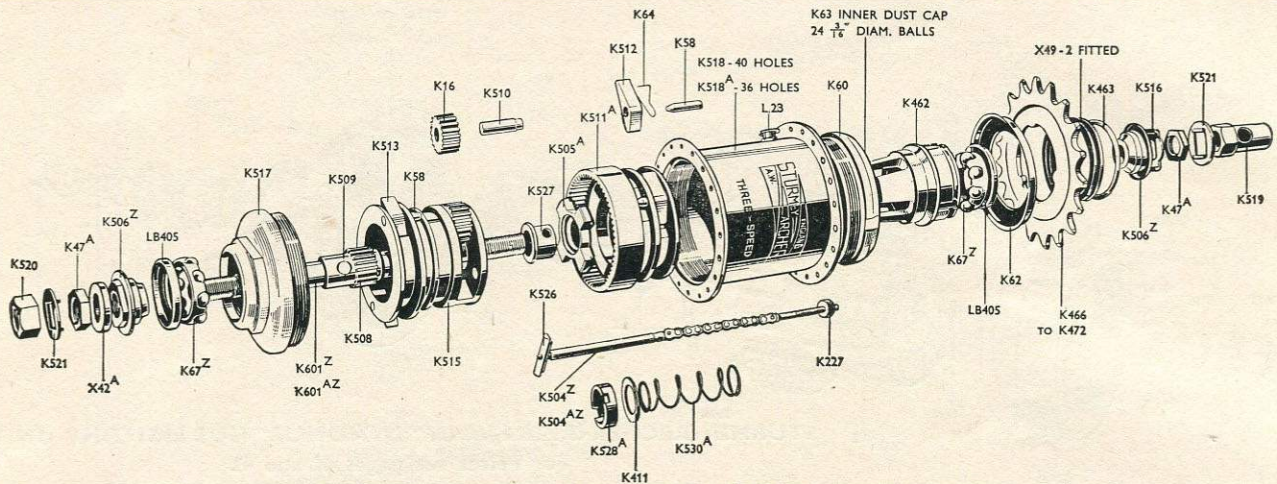

STURMEY-ARCHER A.W. WIDE RATIO 3-SPEED HUB
For Prices see pages 41 and 42

Code No.	Carton Quantity	Description
K601Z	6	Axle complete with Sun Pinion (5 1/2" long)
K601AZ	6	Axle complete with Sun Pinion (6 1/4" long)
K508	12	Sun Pinion only
K509	24	Dowel for Sun Pinion
K515	3	Planet Cage
K527	6	Clutch Sleeve
K505A	12	Sliding Clutch
K526	24	Axle Key
K528A	6	Thrust Ring
K411	6	Thrust Washer
K16	24	Planet Pinion
K510	24	Pinion Ring
K511A	4	Gear Pin
K512	24	Gear Ring Pawl
K64	36	Pawl Spring
K58	24	Pawl Pin
K60	3	R.H. Ball Ring
329	—	Ball Bearings, 3/16" dia. (per set of 24)

Code No.	Carton Quantity	Description
K63	6	Inner Dust Cap
K530A	12	Clutch Spring
K462	6	Driver
K67Z	24	Ball Cage with 1/2" balls
LB405	12	Outer Dust Cap
K506Z	12	Axle Cone with Dust Cap
K516	24	R.H. Cone Locking Washer
K513	24	Low Gear Pawl
K518	1	Shell, 40 holes
K518A	1	Shell, 36 holes
L23	36	Lubricator
K517	2	L.H. Ball Cup

Code No.	Carton Quantity	Description
K519	12	R.H. Axle Nut
K520	24	L.H. Axle Nut
K62	12	Sprocket Dust Cap
K466	6	Sprocket, 16 teeth
K467	6	Sprocket, 17 teeth
K468	6	Sprocket, 18 teeth
K468A	6	Sprocket, 18 teeth for 1/8" wide chain
K469	6	Sprocket, 19 teeth for 1/8" wide chain
K469A	6	Sprocket, 19 teeth for 1/8" wide chain
K470	6	Sprocket, 20 teeth
K472	—	Sprocket, 22 teeth
X49	12	Sprocket Spacing Washer (1/16" thick) (Not illustrated. Alternative to X42A)
K463	6	Circlip

Code No.	Carton Quantity	Description
K519	12	R.H. Axle Nut
K520	24	L.H. Axle Nut
K62	12	Sprocket Dust Cap
K466	6	Sprocket, 16 teeth
K467	6	Sprocket, 17 teeth
K468	6	Sprocket, 18 teeth
K468A	6	Sprocket, 18 teeth for 1/8" wide chain
K469	6	Sprocket, 19 teeth for 1/8" wide chain
K469A	6	Sprocket, 19 teeth for 1/8" wide chain
K470	6	Sprocket, 20 teeth
K472	—	Sprocket, 22 teeth
X49	12	Sprocket Spacing Washer (1/16" thick) (Not illustrated. Alternative to X42A)
K463	6	Circlip

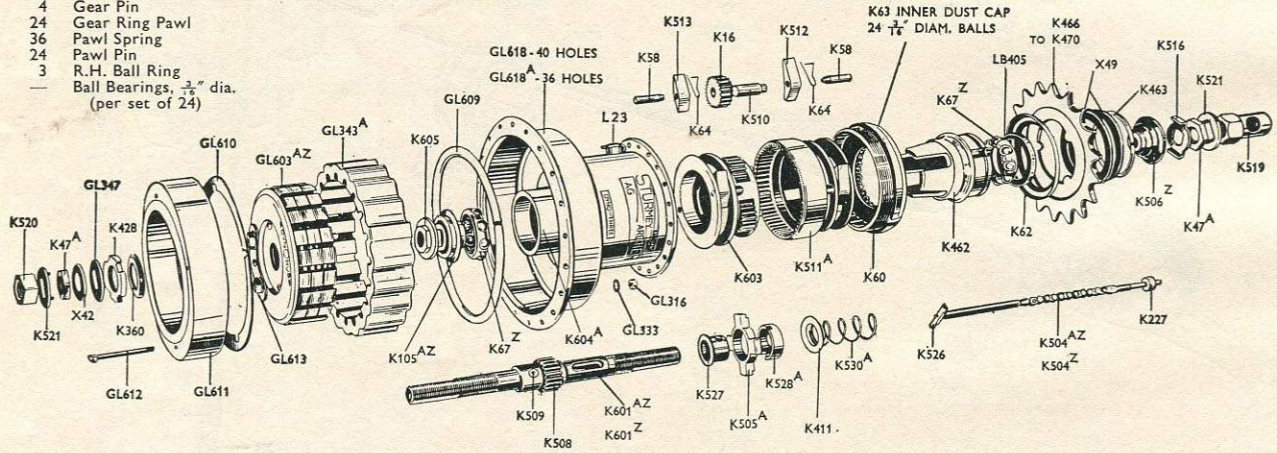

STURMEY-ARCHER WIDE RATIO 3-SPEED HUB COMBINED WITH 6 VOLT "DYNAHUB" For Prices See Pages 41 and 42

Code No.	Carton Quantity	Description
K601AZ	6	Axle complete with Sun Pinion (6 1/4" long)
K601Z	6	Axle complete with Sun Pinion (5 1/2" long)
K508	12	Sun Pinion only
K509	24	Dowel
K603	2	Planet Cage
K527	6	Clutch Sleeve
K505A	12	Sliding Clutch
K526	24	Axle Key
K528A	6	Thrust Ring
K16	24	Planet Pinion
K510	24	Pinion Ring
K511A	4	Gear Pin
K512	24	Gear Ring Pawl
K64	36	Pawl Spring
K58	24	Pawl Pin
K60	3	R.H. Ball Ring
329	—	Ball Bearings, 3/16" dia. (per set of 24)

Code No.	Carton Quantity	Description
K63	6	Inner Dust Cap
K411	6	Thrust Washer
K530A	12	Clutch Spring
K529	12	Clutch Spring Cap
K462	6	Driver
K67Z	24	Ball Cage with 8 1/4" dia. balls
LB405	12	Outer Dust Cap
K506Z	12	R.H. Cone with Dust Cap
K516	24	R.H. Cone Locking Washer
K513	24	Low Gear Pawl
GL618	1	Shell, 40 holes
GL618A	1	Shell, 36 holes
L23	24	Lubricator
K604A	3	L.H. Ball Cup
K105AZ	12	L.H. Cone with Dust Cap
K605	12	Spacing Washer
K504Z	12	Indicator complete for short axle

Code No.	Carton Quantity	Description
K504AZ	6	Indicator complete for long axle
K227	24	Connection Locknut
GL603AZ	1	Armature complete
GL613	12	Terminal Nut
GL343A	1	Magnet
GL609	—	Magnet Spacing Ring
GL610	—	Patent Number Disc
GL611	2	Magnet Cover Plate
GL612	12	Magnet Fixing Screw
GL316	72	Nut for Magnet Fixing Screw
GL333	36	Lock Washer
K360	12	Spacing Washer (1/16" thick)
K428	12	Notched Cone Adjuster
GL347	6	Locking Washer
X42	24	Spacing Washer (1/16" thick)
K47A	24	Cone Locknut
K521	24	Axle Locking Washer

Code No.	Carton Quantity	Description
K519	12	R.H. Axle Nut
K520	24	L.H. Axle Nut
K62	12	Sprocket Dust Cap
K466	6	Sprocket, 16 teeth
K467	6	Sprocket, 17 teeth
K468	6	Sprocket, 18 teeth
K468A	6	Sprocket, 18 teeth for 1/8" wide chain
K469	6	Sprocket, 19 teeth for 1/8" wide chain
K469A	6	Sprocket, 19 teeth for 1/8" wide chain
K470	6	Sprocket, 20 teeth
K472	—	Sprocket, 22 teeth
X49	12	Sprocket Spacing Washer (1/16" thick)
K463	6	Circlip
X42A	24	Axle Spacing Washer (1/16" thick)
K48	—	Lip Washer (Alternatives—Not illustrated)

D 207

W. G. CHEESE LIMITED
CYCLE AND MOTOR ACCESSORIES, WIRELESS
AND ELECTRICAL SUNDRIES

JUPITER HOUSE
326-327, BRADFORD ST., BIRMINGHAM, 5
Telephone: MIDland 5804/5 (2 lines)

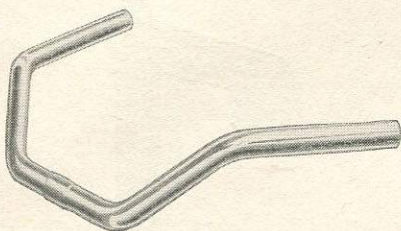

Finished in chromium plate as standard. Black enamelled supplied to order. Stems are supplied 7½" deep as standard. Alternative lengths supplied to order.

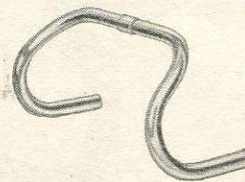

- PHILLIPS HANDLEBAR BENDS**
- No. 344. Speedtrack, 22½" wide. each 9/2
 - H2/601
 - No. 140. Canadian pattern, 20" wide. each 9/8
 - H3/605

- PHILLIPS HANDLEBAR BENDS**
- No. 804. Maes 15½" wide. each 9/2
 - H12/601



- PHILLIPS HANDLEBAR BENDS**
- No. 805. Anelay, 22" wide. each 6/-
 - H4/400

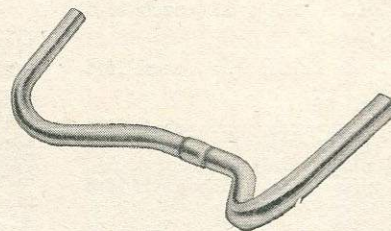

- PHILLIPS HANDLEBAR BENDS**
- No. 370. Light Tourist. Raised or dropped, 20" wide. each 6/11
 - H13/407

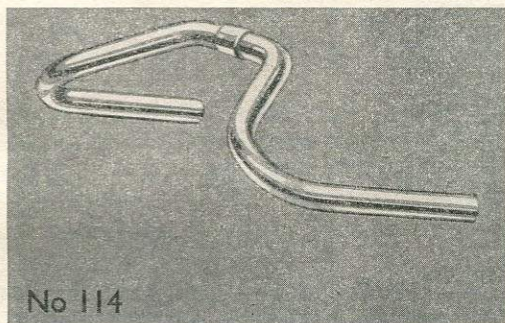

- PHILLIPS HANDLEBAR BENDS**
- No. 114. Marsh Level Grip. 16½" wide. Supplied 18" wide to order. each 10/5
 - H5/611

- PHILLIPS HANDLEBAR BENDS**
- No. 134. Light Tourist. Flat, 20" wide. each 8/11
 - H17/511

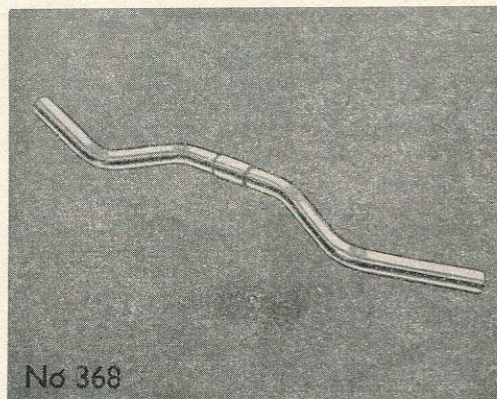

- PHILLIPS HANDLEBAR BENDS**
- No. 368. All Rounder. 22" wide. each 6/-
 - H15/400

- JUPITER HANDLEBAR BENDS**
- H18/601 Maes, 15½" wide ... each 9/2
 - H19/400 Anelay, 22" wide ... each 6/6
 - H20/310 Anelay, 22" wide (in one-dozen lots) ... each 0/0
 - H21/500 Light Tourist. Raised or dropped, 20" wide ... each 7/6
 - H22/500 Light Tourist. Flat, 20" wide ... each 7/6
 - H23/400 All Rounder, 22" wide ... each 6/6
 - H24/310 All Rounder, 22" wide (in one-dozen lots) ... each 0/0
 - H25/600 Speedtrack Bend ... each 9/-



- PHILLIPS SEAT PILLARS**
- H6/Trade F802 Forward Pattern ... each 2/5
 - H7/Trade F822 Straight Pattern, 9" ... each 1/4
 - H9/Trade F824 90° Tricycle Pattern ... each 1/8
 - H10/Trade F826 71° Kiddies' Pattern ... each 1/8

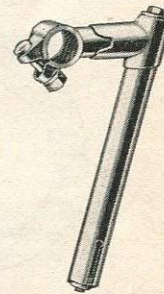
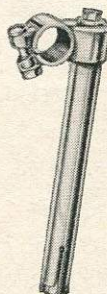

- PHILLIPS HANDLEBAR STEMS**
- Stems are supplied 7½" deep as standard. Alternative lengths to order.
- H16/510 No. 276. 1¼" extension ... each 8/9

C 245

W. G. CHEESE LIMITED
 CYCLE AND MOTOR ACCESSORIES, WIRELESS
 AND ELECTRICAL SUNDRIES

JUPITER HOUSE
 326-327, BRADFORD ST., BIRMINGHAM, 5
 Telephone: MIDland 5804/5 (2 lines)

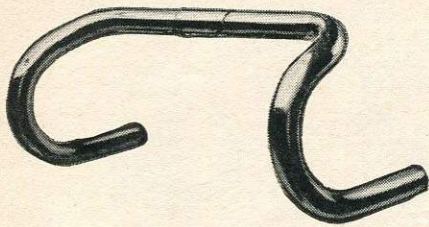

G.B. ALLOY HANDLEBARS

- Maes. 14 $\frac{3}{4}$ " 1 $\frac{5}{16}$ " diameter.
 H30/1100 each 16/6
- R.H. Maes. 16".
 H31/1100 each 16/6
- Road Champion. 16".
 H32/1100 each 16/6
- Touring Bend. 15 $\frac{1}{2}$ ". Only 4" drop.
 H33/1100 each 16/6
- Capo Berta.
 H34/1100 each 16/6
- All Rounder Bend.
 H35/800 each 12/-
- Comfort Bend.
 H36/800 each 12/-

STRATA ALLOY ENDS

- Maes. 1 $\frac{5}{16}$ " Polished.
 H40/1004 each 15/6
- South of France.
 H41/1004 each 15/6
- Pelissier.
 H42/1004 each 15/6

PHILLIPS HANDLEBAR BENDS

- No. 344. Speed Track. 22 $\frac{1}{2}$ " wide \times $\frac{7}{8}$ " dia.
 H44/601 each 9/2

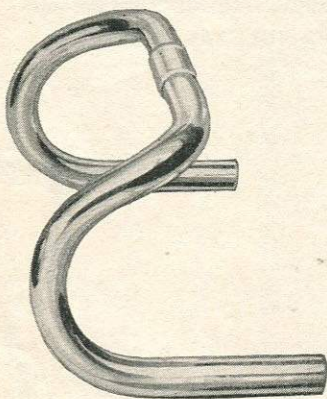

CRESTA HANDLEBAR BENDS

- Maes Alloy. 1 $\frac{5}{16}$ " dia. With engraved ferrule
 1" dia.
 H43/1006 each 15/9

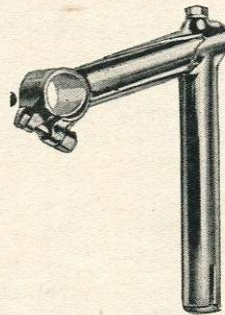

G.B. KROMO STEEL STEMS

- H45/1608. 2 $\frac{3}{8}$ " each 25/-
 H46/1608. 3" each 25/-
 H47/1608. 3 $\frac{5}{8}$ " each 25/-
 H48/1708. 4" each 26/6
 H49/1708. 4 $\frac{1}{2}$ " each 26/6
 H50/1708. 4 $\frac{1}{2}$ " each 26/6
 H51/1900. 5" each 28/6

JUPITER HANDLEBAR STEMS

- Chromium plated.
 H52/600. 1" each 9/-
 H53/600. 2" each 9/-
 H54/604. 3". Continental each 9/6

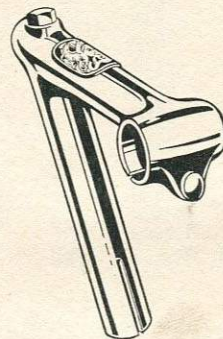

CINELLI HANDLEBAR STEMS

- Chrome Steel. No. 1 Standard road model—
 plain. With name badge.
 H60/2000 each 30/-
 Sizes: 2 $\frac{1}{2}$ ", 3", 3 $\frac{1}{2}$ ", 4" and 4 $\frac{1}{2}$ ".

CINELLI HANDLEBAR BENDS

- Chromed Steel.
 No. M15. Tour of Britain. Width 15 $\frac{1}{2}$ ",
 Drop 6 $\frac{1}{2}$ ", Forward 3 $\frac{1}{2}$ ". Engraved.
 H70/1600 each 24/-
 No. M16. Campione del Mondo. Width 15",
 Drop 5 $\frac{3}{4}$ ", Forward 3 $\frac{1}{2}$ ". Engraved.
 H71/1600 each 24/-
 No. M17B. Giro D'Italia. Width 15", Drop
 5 $\frac{1}{2}$ ", Forward 4 $\frac{3}{4}$ ". Engraved.
 H72/1600 each 24/-

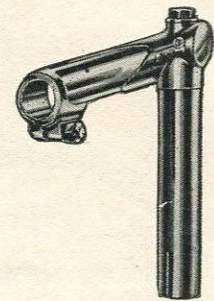

CINELLI EXPANDER BOLT

- H73/104 Complete each 2/-

LENCO SPORTS STEMS

- H84/1104 2 $\frac{1}{2}$ " each 17/-
 H85/1108 3" each 17/6
 H86/1204 3 $\frac{1}{2}$ " each 18/6
 H87/1300 4" each 19/6
 H88/1308 4 $\frac{1}{2}$ " each 20/6

G.B. SOLID FORGED ALLOY STEMS

- H77/1008. 1 $\frac{3}{4}$ " each 16/-
 H78/1200. 2 $\frac{3}{4}$ " each 18/-
 H79/1302. 3 $\frac{1}{2}$ " each 19/9

G.B. ALLOY EXPANDER BOLTS

- H80/102 Complete each 1/9

G.B. HANDLEBAR PACKING FERRULE

- H81/304 doz. each 5d.

JUPITER EXPANDER BOLTS

- 6", 7", 8" or 9".
 H83/1011 doz. each 1/5

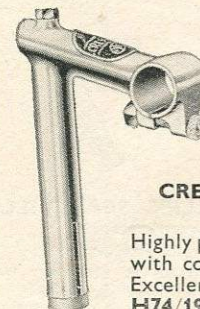

CRESTA HANDLEBAR STEM

- Highly polished and chrome plated
 with coloured name plate.
 Excellent quality.
 H74/1903 each 28/11

D 14

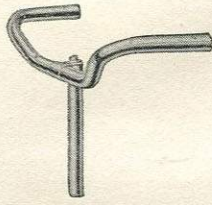

PHILLIPS HANDLEBARS
No. 87 North Road Raised 19" wide.
H81/902 Chromium plated ... each 13/9

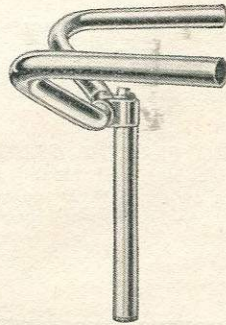

PHILLIPS HANDLEBARS
No. 135. Light Tourist. 20" wide. Chromium plated.
H86/907 ... each 14/5

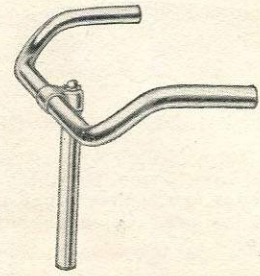

PHILLIPS HANDLEBARS
No. 85. Raised. 18" wide. 20" wide to order. Chromium plated.
H92/901 ... each 13/8

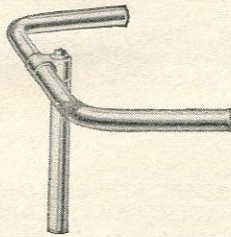

PHILLIPS HANDLEBARS
No. 86. Standard flat, 18" wide. 20" wide to order. Chromium plated.
H89/901 ... each 13/8

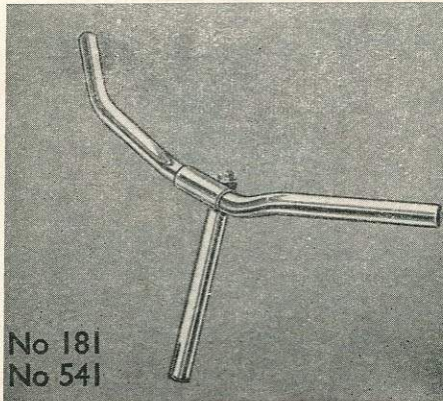

PHILLIPS HANDLEBARS
No. 181. All Rounder, 19 1/4" wide.
H87/902 ... each 13/9
No. 541. All Rounder, 23 1/2" wide.
H88/1003 ... each 15/5

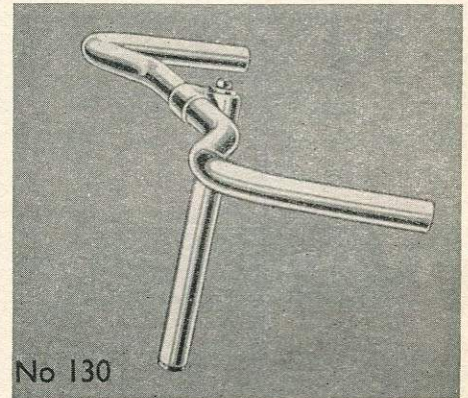

PHILLIPS HANDLEBARS
No. 130. North Road flat. 19" wide. Chromium plated.
H95/902 ... each 13/9

PHILLIPS HANDLEBARS WITH ROLLER LEVER BRAKES

Vox Populi raised with Double Brakes and Expander Bolt.

H83/3501 ... each 52/8

Vox Populi North Road raised with Double Brakes with Expander Bolt.

H84/3505 ... each 53/2



PHILLIPS EXPANDER BOLTS

Fitted as standard to all handlebars.

H89/Trade		
No.	Suitable for:—	Per doz.
S1008x	All Standard Handlebars	1104
S1008k	Kiddies	1104
S1015x	Carrier	1208

PHILLIPS HANDLEBARS WITH ROLLER LEVER BRAKES

Carrier raised with Double Brakes and Expander Bolt.

H96/3011 ... each 46/5

PHILLIPS HANDLEBARS WITH EXPANDER BOLTS

With Roller Lever Brakes. Expander Bolts are fitted as standard on all models. Chromium plated.

Celtonia Ordinary, raised. With Front and Rear Brakes. 18" wide.	H97/2704	per set 41/-
Celtonia North Road, raised. With Front and Rear Brakes. 18" wide.	H98/2707	per set 41/5
Celtonia, flat. With Front and Rear Brakes. 20" wide.	H99/2707	per set 41/5
Celtonia North Road, dropped. With Front and Rear Brakes. 18" wide.	H100/2707	per set 41/5
Yoke and Hinge, raised. With Front and Rear Brakes. 18" wide.	H101/2903	per set 43/11
Yoke and Hinge North Road, raised. With Front and Rear Brakes. 18" wide.	H102/2907	per set 44/5
Philco Kiddies. N.R., raised. With Front Brake only. 16" wide.	H103/1808	per set 28/-
Philco Kiddies. N.R., raised. With Front and Rear Brakes. 16" wide.	H104/2403	per set 36/5

G 32

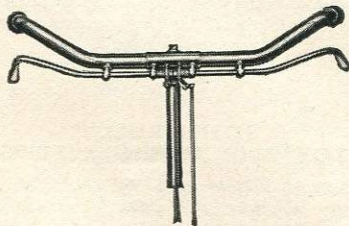

W. G. CHEESE LIMITED
 CYCLE AND MOTOR ACCESSORIES, WIRELESS
 AND ELECTRICAL SUNDRIES

JUPITER HOUSE
 326-327, BRADFORD ST., BIRMINGHAM, 5
 Telephone: MIDland 5804/5 (2 lines)



DARE RUBBER CYCLE GRIPS

No. FG1. Finger Grips. $4\frac{1}{4}'' \times \frac{7}{8}''$. Colours: Black, Red, Beige, Green, Grey, Tan, Blue.
H127/1304 doz. prs. Black per pair 1/8
H128/1504 doz. prs. Coloured per pair 1/11
 1600 2-0



DARE RUBBER CYCLE GRIPS

No. SG1. Senior Grips. $4\frac{1}{4}'' \times \frac{7}{8}''$. Colours: Black, Red, Beige, Green, Grey, Tan, Blue.
H130/903 doz. prs. Black per pair 1/2
H131/1009 doz. prs. Coloured per pair 1/4
No. JG1. Junior Grips, $3'' \times \frac{3}{4}''$. Colours: Black, Red, Beige, Green, Grey, Tan, Blue.
H132/800 doz. prs. Black per pair 1/-
H133/903 doz. prs. Coloured per pair 1/2



DARE PLASTIC SLEEVE GRIPS

No. PG1. 7" suitable for $\frac{7}{8}''$ and $\frac{5}{8}''$ handlebars. Black, Red, Blue, Yellow and Green.
H135/102 ... per pair 1/9
No. PG5. Sleeve Grip Sets comprising 1 pair PG1 7" sleeve, 1 pair PG6 8" sleeve O/E suitable for $\frac{7}{8}''$ and $\frac{1}{2}''$ handlebars.
H137/3103 doz. prs. ... per set 3/11

PRAM SLEEVING

White, Green, Blue, Red or Beige.
H141/1800 doz. 26" ... each 2/3



DARE GOLDENLINE PLASTIC CYCLE GRIPS

No. GL01. Finger Grips, 6 pairs on card* Red, Blue, Green, Grey, Beige, Black, White.
H145/106 ... per pair 2/3
No. GL05. Juvenile Cycle Handlebar Grip. 12 pairs on card. Assorted colours. $3'' \times \frac{3}{4}''$.
H146/010 ... per pair 1/3



DARE PLASTIC GRIPS

No. GL02. Scooter and Moped Handlebar Grips. 6 pairs on card. Assorted colours.
H147/106 ... per pair 2/3



DARE BRAKE LEVER GRIPS

No. GL03. Brake Lever Grips. 12 pairs on card. Assorted colours.
H148/1000 ... per pair 1/3



DARE HANDLEBAR END PLUGS

No. GL04. Handlebar End Plugs. 18 pairs on card. White only. Suitable for $\frac{7}{8}''$ and $\frac{1}{2}''$ handlebars.
H149/1200 per card ... per pair 1/-



"RADSPORT" EMBOSSED PLASTIC HANDLEBAR TAPE

Opaque. Red, White, Black, Yellow, Green, Blue, Ice Blue.
Transparent. Red, Blue, Green.
H151/804 50-yd. rolls ... each 12/6
H152/08 3-yd. rolls ... each 1/-

"RADSPORT" EMBOSSED PLASTIC P.V.C. TAPE

Red, White, Black, Yellow, Green, Blue, Ice Blue.
H153/100 5-yd. rolls ... each 1/6

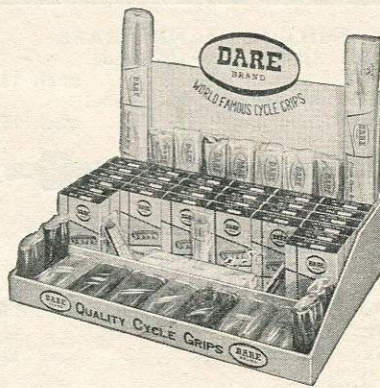

DARE CYCLE COUNTER DISPLAY

H150/-/ ... complete /-/



JOHN BULL GRIPS

No. 30. $3\frac{3}{4}''$ long. Packing Unit 6. Grey or Black.
H158/800 doz. pairs per pair 1/-

JOHN BULL CUSHION GRIPS

Pat. No. 402560 and 480814. For $\frac{7}{8}''$ bars. Cushion 4" long. Boxed in pairs.
H156/103 Black ... per pair 1/10
H157/109 Grey ... per pair 2/8



JOHN BULL DIAMOND PATTERN GRIPS

6" long. Black, Red, Green, Blue, White, Grey. Packing unit 12.
H159/1904 doz. ... per pair 2/5

JOHN BULL TOY AND JUVENILE GRIPS

Six pairs on display card.
Toy $2\frac{5}{8}''$ long for $\frac{3}{8}''$ bars Gristly
Juvenile $3\frac{1}{4}''$ long for $\frac{3}{8}''$ bars Black
Juvenile $3\frac{1}{4}''$ long for $\frac{1}{2}''$ bars Black
H161/1200 ... per doz. pairs 18/-

A 12 20

W. G. CHEESE LIMITED
 CYCLE AND MOTOR ACCESSORIES, WIRELESS
 AND ELECTRICAL SUNDRIES

JUPITER HOUSE
 326-327, BRADFORD ST., BIRMINGHAM, 5
 Telephone: MIDland 5804/5 (2 lines)

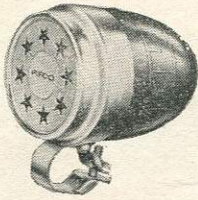

PIFCO KIDDY HORN

No. 1227. Squeeze horn for Cycles or Tricycles. 2" dia. silver bright aluminium head with star apertures. Patterned rubber bulb in assorted colours. Size 3" x 3" overall.
H211/110 each 2/9



SHOCKSTOP HANDLEBAR END PLUGS

Black and all colours. Interior fitting.
H218/008 per pair 1/-



DAWES HANDLEBAR END PLUGS

H220/1000 doz. per pair 1/3

DUNLOP HANDLEBAR END PLUGS

Six pairs per card. Available in Black, White, Red, Blue or Green. Complete with expanders.

H221/106 Black per pair 2/3
H222/1010 Coloured per pair 2/9

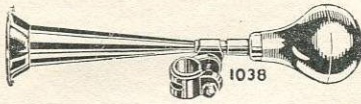

STARLITE CYCLE HORNS

No. 1038. Complete with adjustable two-piece clip. Length, 11" overall. Fitted with No. 2 size rubber bulb. Chromium-plated finish.
H213/408 each 7/6

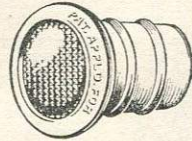

STARLITE HANDLEBAR END PLUGS

No. 1307. Plastic, fitted with reflector. Red, Blue or White.
H219/2000 doz. prs. per pair 2/6



SHOCKSTOP SLEEVE GRIPS

In Black, Beige, Red, Silver-Grey, Blue or Green.

No.	Per pair
H233/1000 doz. pairs 59. 4" long	1/3
H234/1208 doz. pairs 57. 6 1/2" long	1/7
H235/1608 doz. pairs 53. 7 3/8" long	2/1

ACUMEN HORNS

No. 7. Pip-pip horn, 7" long, colour Red.
H226/2000 doz. each 2/6
 No. 8. Medium horn, 8" long, chrome.
H227/206 each 3/9
 No. 9. 10 1/2" long, chrome plated.
H228/311 each 5/11

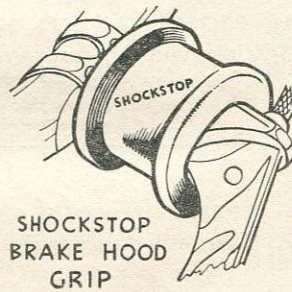

SHOCKSTOP BRAKE HOOD GRIP

SHOCKSTOP BRAKE HOOD GRIPS

Standard Type. Black only.
H223/106 per pair 2/3

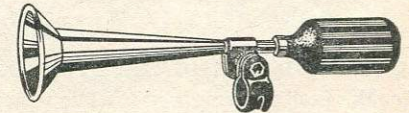

STADIUM BULB HORNS

No. 110C. Chromium plated, steel bracket. Red or black bulb.
H236/508 each 8/6

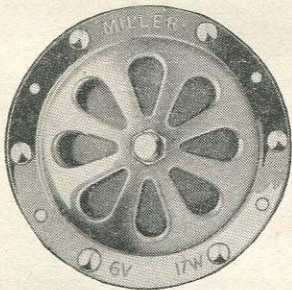

MILLER A.C. BUZZER

No. AC2. Fitted with angle bracket and suitable for use in conjunction with flywheel magnetos having a lighting output of 17 watts and over.
H215/1000 With Switch each 15/-

DAWES BRAKE LEVER RUBBERS

H224/102 per pair 1/9

TWILL TAPE

5-yard rolls. Assorted colours.
H225/1504 each 2/-
 Purchase Tax 9d. doz.

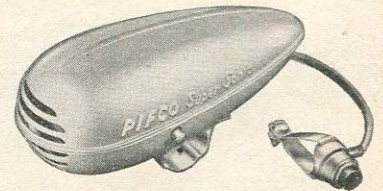

PIFCO SUPERSONIC HOOTER

A loud, clear warning signal at the touch of a button. Size, 5 3/4" x 2 1/2" x 2 1/4". Less battery.

No. 1229. Chrome-plated finish.
H239/507 each 8/4

No. 1228. Matt Silver finish.
H240/408 each 6/11

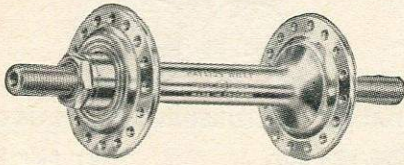

B.W. FRONT HUB

No. 23. Flanges machined from Hiduminium alloy. $\frac{3}{16}$ " ball bearings. Hub centre machined from solid for maximum strength. Spindle hollowed for lightness and fitted with washers and locknuts. Drilled 32 or 36 holes to order. Chromium-plated finish.

H266/1104 each 17/-

B.W. STANDARD "IDEAL" FRONT HUB

No. 100. Solid cast. Medium diameter barrel. $\frac{5}{16}$ " spindle. Drilled 32 or 36 holes to order. Cone lock nuts if required. Chrome or black finish. Pairs with "Ideal" rear.

H267/309 each 5/7

B.W. CARRIER CYCLE FRONT HUB

No. 608. Specially strong malleable cast shell with $\frac{3}{8}$ " spindle and $\frac{1}{4}$ " balls. Drilled 32 or 36 holes for 13 gauge spokes. Pairs with No. 4 Rear Hub.

H268/409 each 7/2

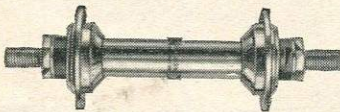

B.W. CLUB RACING FRONT HUBS

No. 51. Small diameter barrel. 32 or 36 holes to order. Fitted with cone lock nuts, fit washer and specially grooved spindle. Chrome or black finish. Pairs with Rear Hub No. 5 or 5A. Weight $6\frac{1}{2}$ ozs.

H269/402 $\frac{1}{2}$ each 6/4

No. 52. As No. 51, but with roadster spindle and flat faced cones.

H270/402 $\frac{1}{2}$ each 6/4

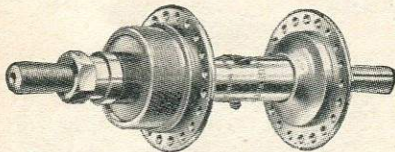

B.W. REAR HUB

No. 300. An all-steel Derailleur type hub, single sided to suit Gear Cluster $\frac{9}{16}$ " to $\frac{5}{8}$ " when measured from back face to centre.

H271/704 each 11/10

No. 310. Gear and fixed.

H272/704 each 11/-

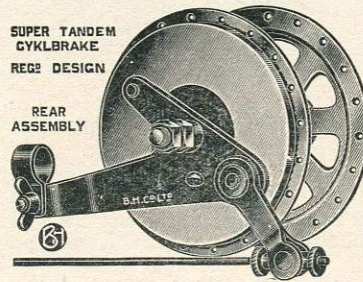

B.H. REAR TANDEM HUB

Super Special. With $4\frac{3}{4}$ " Brake Drum.
H273/4805 each 69/-

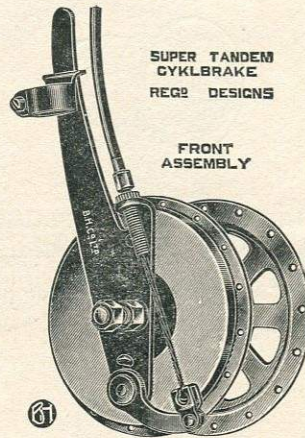

B.H. FRONT TANDEM HUB

Super Special. With $4\frac{3}{4}$ " Brake Drum.
H274/4306 each 62/3

RESILION HUBS

No. 557. Front, with double lock nuts.
H275/707 each 11/5

No. 559. Rear. Screwed for three-speed Derailleur with $\frac{1}{8}$ " chain, also suitable for four-speed Derailleur with $\frac{3}{32}$ " chain.
H276/1008 each 16/-

No. 560. Rear. Screwed for four-speed Derailleur with $\frac{1}{8}$ " chain, also suitable for five-speed Derailleur with $\frac{3}{32}$ " chain.
H277/1008 each 16/-

No. 561. Rear. Screwed for cog and lock ring both sides.
H278/1005 each 15/8

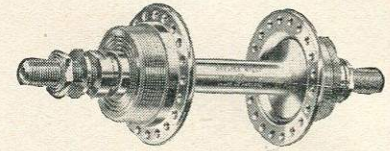

B.W. REAR HUB

No. 25. Same specification as above, but with $\frac{1}{4}$ " ball bearings. Screwed for multiple gears and fitted with long cone and packing washers to enable the necessary adjustment to be made over the cones to accommodate any specific gear. Drilled 40 holes or special to order. Chromium-plated finish.

H288/1500 each 22/6

B.W. STANDARD "IDEAL" REAR HUB

No. 200. Drilled 36 or 40 holes to order. Spindle lock nuts to order. Chain line (gear case clearance) $1\frac{1}{2}$ ". Chrome or black finish. Pairs with "Ideal" front hub.

H289/507 each 8/5

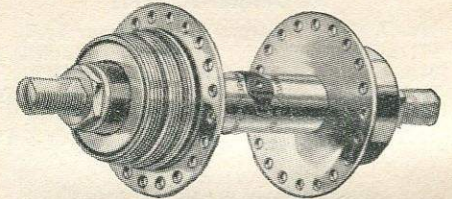

B.W. CLUB RACING REAR HUB

No. 501. An all-steel single sided rear hub with shouldered spindle, $\frac{5}{8}$ " dia. barrel and screwed for standard offset sprocket. Pairs with No. 51 Front Hub. Chrome or black finish. With cone locknuts and flatted spindle.

H291/509 each 8/8

B.W. REAR ROAD RACING HUBS

No. 503. $1\frac{1}{2}$ " chain line, with central sprocket or inset freewheel, small diameter barrel, steel alloy shell, screwed for cog and locknut both sides. Drilled 36 or 40 holes. Fitted with locking cones and special spindles for racing fork ends. Pairs with No. 9 Front Hub. Chrome or black finish. Less nuts.

H292/601 each 9/1

Y J 3

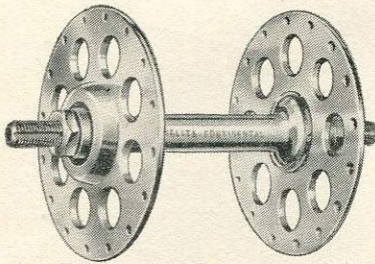

**"AIRLITE-CONTINENTAL"
FRONT D.S. HUB**

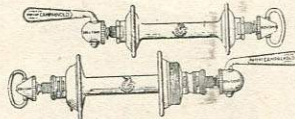

**CAMPAGNOLO QUICK RELEASE
HUBS**

Small flange, Front.	H380/2204	each 33/6
Small flange, Rear.	H381/2608	each 40/-
	H382/4606	per pair 69/9
Large flange, Front.	H383/3304	each 50/-
Large flange, Rear.	H384/3608	each 55/-
	H385/6606	per pair 99/9

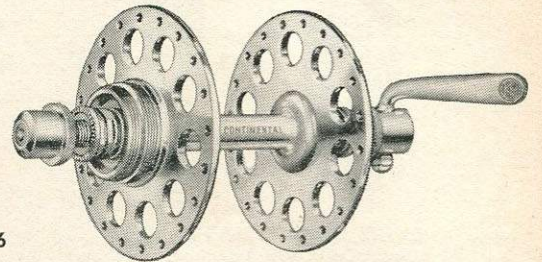

**B.H. "AIRLITE-CONTINENTAL"
FRONT HUB**

With quick-release unit.
H392/3011 each 44/1

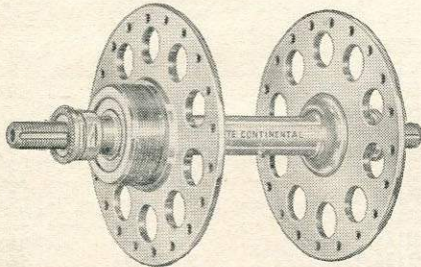

**"AIRLITE-CONTINENTAL"
REAR HUB**

D.S. Double Cog Racing Hub 1 1/2" Chain Line.
H365/2301 Front each 33/-
H366/3302 Rear each 47/2

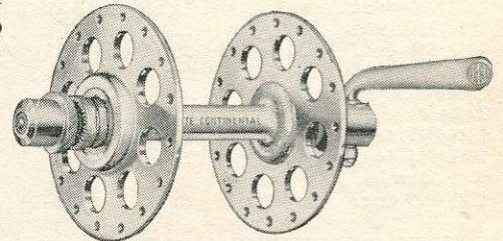

**B.H. "AIRLITE-CONTINENTAL"
REAR HUB**

With quick-release unit.
H393/4102 each 58/7

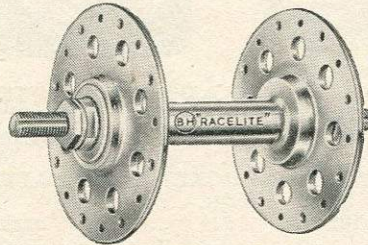

B.H. "RACELITE" REAR HUBS

H370/1406 each 21/6

The rear hub is available as follows:
G.1. For Deraillleur Gear.
G.1.2. For Deraillleur Gear and Fixed Cog.
D.S. For Double Fixed Cog.
S.S. For Single Sided Fixed Cog.
Weight 16 ozs. per pair.

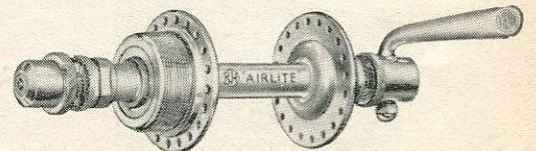

B.H. "AIRLITE" FRONT HUB

With quick release. Small flange.
H375/2106 each 30/8

"Airlite" Hubs can be supplied with flanges anodised Green, Gold, Red and Blue at extra cost.

H376/206 per pair 3/9

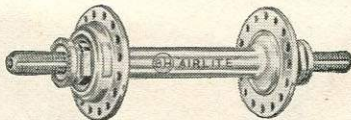

"AIRLITE" CYCLE D.S. FRONT HUB

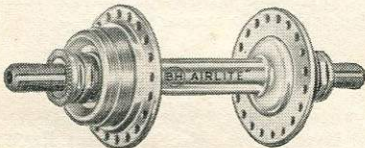

"AIRLITE" CYCLE D.S. REAR HUB

H368/1309 Front each 19/7
H369/2107 Rear each 30/10

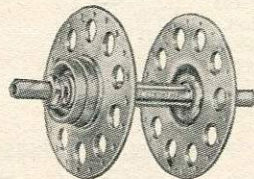

B.H. "RACELITE" FRONT HUBS

Large flange light alloy Racing Hubs.
H373/1100 each 16/2

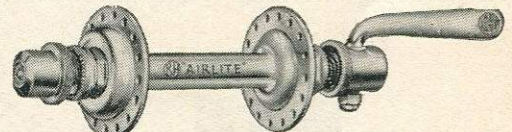

B.H. "AIRLITE" REAR HUB

"Airlite" S.S. Rear with quick-release unit, for single sprocket and locking 1 1/2" C.L.

"Airlite" D.S. Rear with quick-release unit, for double-sided sprocket and locking 1 1/2" C.L.

H378/2902 each 41/9



EVER READY BATTERIES
(Unit Cells for Torches, etc)

No.	Description	L30/Coded	Each
Cylindrical, 1½ volts.			
U1/211 doz.	Midget	4d.
U2/501 doz.	Large	7d.
U8/207 doz.	Bijou	3½d.
U10/303 doz.	Standard	4½d.
U11/308 doz.	Baby	5d.
U12/207 doz.	Penlight and Toys	3½d.
U14/2109 doz.	Gaslighter	2/6
U17/510 doz.	Radio Cell	8d.
U18/510 doz.	Small Gaslighter Cell	...	8d.
Cylindrical, 3 volts.			
8/501 doz.	Bijou	7d.
1839/703 doz.	Baby	10d.
1915/501 doz.	Penlight	7d.
Flat, 1½ volts.			
1289/809 doz.	Standard	1/-

EVER READY TWIN BATTERY
FOR CYCLE LAMPS

L32/Coded	Description	Each
800/1108 doz.	Large Twin (3 volts)	1/4



EVER READY BOX BATTERIES

No.	Description	L34/Coded	Each
15/2311 doz.	Handlamp (4½ volts)	2/9
126/2311 doz.	Bell (4½ volts)	2/9
481/9600 doz.	Handlamp (4½ volts)	11/-



No.	Description	Each
996/3208 doz.	Lantern (6 volts) ...	3/9
1215/2311 doz.	Handlamp (4½ volts) ...	2/9



RAY-O-VAC TWIN CYCLE BATTERY
No. 9LP. 3 volts.

L36/104 ... each 1/11



RAY-O-VAC FLASHLIGHT BATTERY

No. 2LP. Single Cell. 1½ volts.
L37/07 ... each 10d.



RAY-O-VAC POCKET LAMP BATTERY

No. 15LP. 4½ volts.
L38/101 ... each 1/6



EVER READY "BATRYMAN" RADIO BATTERIES

No.	Voltage		L41/Coded	Each
	H.T.	L.T.		
B101/803 ...	67½	—	...	11/-
B102/609 ...	45	—	...	9/-
B103/1306 ...	90	1½	...	18/-
*B104/508 ...	45	—	...	7/6
B107/909 ...	90	—	...	13/-
B114/508 ...	69	1½	...	7/6
B117/909 ...	90	—	...	13/-
B126/605 ...	90	—	...	8/6
B127/1500 ...	85½	7½	...	20/-
B129/1205 ...	85½	—	...	16/6
B136/1207 ...	90	1½	...	16/9
B137/2603 ...	90	1½	...	35/-
B138/1205 ...	90	—	...	16/6
B147/1103 ...	90	1½	...	15/-
B148/1101 ...	90	7½	...	14/9

* For small or large 3-pin plug, with locating pins.



EVER READY RADIO DRY BATTERIES
"WINNER" SERIES

No.	L.T.	G.B.	L39/Coded	Each
Grid Bias	—	—	...	1/8
Winner 9/103 ...	—	9	...	13/3
High Tension.	108	—	...	13/6
Winner 108/1000	120	—	...	14/-
Winner 120/1002	111	9	...	15/9
Winner 120GB/1006	*126	—
Winner 126GB/1110

"PORTABLE" SERIES

No.	L.T.	G.B.	L40/Coded	Each
Portable 32/1606	110½	9	...	22/-
Portable 34/1205	120	9	...	16/6
Portable 40/1306	135	9	...	18/-
Portable 61/706 ...	90	—	...	10/-
Portable 75/1302	*136½	—	...	17/6

* Tapped Sockets every 1½ volts to 12 volts.

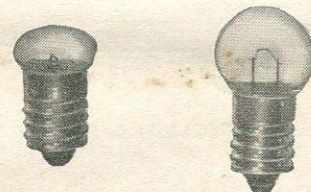

EVER READY FLASHLIGHT BULBS

For all types of flashlight torches, pocket lamps, cycle and handlamps and for fuse and dial lamps of radio receivers.

L42/K

No.	Description	Volts	Amps.	Each	P.T.
1427	11 ^m / _m Round	1.25	.25	4d.	1d.
1890	11 ^m / _m Flat ...	2.5	.22	4d.	1d.
2111	11 ^m / _m Round*	2.5	.3	4d.	1d.
2112	11 ^m / _m Round*	3.5	.3	4d.	1d.
2114	15 ^m / _m Round*	5.5	.3	7d.	1d.

*Spotlight Filament

K 93

W. G. CHEESE LIMITED
CYCLE AND MOTOR ACCESSORIES, WIRELESS
AND ELECTRICAL SUNDRIES

JUPITER HOUSE
326-327, BRADFORD ST., BIRMINGHAM, 5
Telephone: MIDland 5804/5 (2 lines)



VITALITY BULBS L60/K

Ref. Clear Balloon	Ref. Prismatic Balloon	Volts	Rating Amps.	Watts	Balloon Size	Shape	Cap	Retail Price ex. P.T.	Purchase Tax
For Most Makes of Cycle Dynamo									
164	43	4	.3	1.2	15 ^m / _m	Ball	M.E.S.	1/-	2d.
176	—	6	.3	1.8	15 ^m / _m	Ball	M.E.S.	9d.	1½d.
178	—	6	.45	2.7	15 ^m / _m	Ball	M.E.S.	9d.	1½d.
180	—	6	.5	3.0	15 ^m / _m	Ball	M.E.S.	9d.	1½d.
962	963	6	.3	1.8	18 ^m / _m	Ball	S.C.C.	1/4	3d.
2	3	6	.5	3.0	18 ^m / _m	Ball	S.C.C.	1/4	3d.
—	9	6	1.0	6.0	18 ^m / _m	Ball	S.C.C.	1/4	3d.
—	49	6	.3	1.8	15 ^m / _m	Ball	M.E.S.	8d.	1½d.
—	51	6	.45	2.7	15 ^m / _m	Ball	M.E.S.	8d.	1½d.
—	52	6	.5	3.0	15 ^m / _m	Ball	M.E.S.	8d.	1½d.

SALES DISPLAY OF VITALITY CYCLE DYNAMO BULBS

Brilliant display in Red, Black and Yellow containers:

174 Bulbs—All the best sellers in the proportions in which they sell.

94—G194 Tail Bulbs for most Dynamo Sets.

40—No. 52 Head Bulbs for Lucas, Miller and other 6 volt 3 watt sets.

40—No. 87 Head Bulbs for Sturmey-Archer 6 volt Dynohubs.

L55/7704 complete £5 16 0
Plus Purchase Tax 18/8

Suitable only for Raleigh and Sturmey-Archer Dynohubs and B.S.A. Hublites

1206	—	6	.2	1.2	15 ^m / _m	Ball	M.E.S.	9d.	1½d.
1207	—	6	.25	1.5	15 ^m / _m	Ball	M.E.S.	9d.	1½d.
1208	—	6	.3	1.8	15 ^m / _m	Ball	M.E.S.	9d.	1½d.
1212	62	8	.15	1.2	15 ^m / _m	Ball	M.E.S.	1/4	3d.
234	37	8	.15	1.2	18 ^m / _m	Ball	Shld.	1/4	3d.
952	40	12	.23	2.76	18 ^m / _m	Ball	Shld.	1/4	3d.
—	86	6	.2	1.2	15 ^m / _m	Ball	M.E.S.	8d.	1½d.
—	87	6	.25	1.5	15 ^m / _m	Ball	M.E.S.	8d.	1½d.
—	88	6	.3	1.8	15 ^m / _m	Ball	M.E.S.	8d.	1½d.

Suitable for Dynamo Tail Bulbs.

207	—	1.5	.15	.225	11/12 ^m / _m	Ball	M.E.S.	1/4	3d.
202	—	2.5	.25	.625	11/12 ^m / _m	Ball	M.E.S.	1/4	3d.
G191	—	3.5	.15	.525	11/12 ^m / _m	Ball	M.E.S.	9d.	1½d.
194	—	6.0	.04	.24	15 ^m / _m	Ball	M.E.S.	8d.	1½d.
G194	—	6.0	.04	.24	11/12 ^m / _m	Ball	M.E.S.	8d.	1½d.
G195	—	6.0	.1	.6	11/12 ^m / _m	Ball	M.E.S.	8d.	1½d.
191	—	3.5	.15	.525	15 ^m / _m	Ball	M.E.S.	9d.	1½d.
G209	—	6.0	.15	.9	11/12 ^m / _m	Ball	M.E.S.	9d.	1½d.

Head and Tail Bulbs for Mopeds.

425	—	6	—	1.5	15 ^m / _m	Ball	M.E.S.	9d.	1½d.
429	—	6.2	—	2	15 ^m / _m	Ball	M.E.S.	9d.	1½d.
445	—	6	—	3	15 ^m / _m	Ball	M.E.S.	8d.	1½d.
55	—	6	—	6	15 ^m / _m	Ball	M.E.S.	9d.	1½d.
430	—	6.2	—	2	15 ^m / _m	Ball	M.C.C.	10d.	2d.
446	—	6	—	3	15 ^m / _m	Ball	M.C.C.	10d.	2d.
834	—	6	—	6	15 ^m / _m	Ball	M.C.C.	10d.	2d.
—	9	6	—	6	18 ^m / _m	Ball	S.C.C.	1/4	3d.
—	3	6	—	3	18 ^m / _m	Ball	S.C.C.	1/4	3d.
G445	—	6	—	3	11 ^m / _m	Ball	M.E.S.	8d.	1½d.
G429	—	6.2	—	2	11 ^m / _m	Ball	M.E.S.	9d.	1½d.
G430	—	6.2	—	2	11 ^m / _m	Ball	M.C.C.	10d.	2d.
G446	—	6	—	3	11 ^m / _m	Ball	M.C.C.	10d.	2d.



EVER READY GAS LIGHTER

No. 2247. Complete with burner.

L56/400 Plus Duty 4/- each 6/-

Spare Burners.

L57/100 each 1/6

EVER READY GAS LIGHTER BATTERY

No. U14.

L58/110 each 2/6



MILLER CYCLE LAMP BULBS

No. 650. 6 volt 0.5 amp. (M.E.S.) for Head and Pilot Bulbs. 15^m/_m dia. Gas filled.

L62/600 doz. each 9d.

Plus Purchase Tax.

No. 604. 6 volt 0.04 amp. (M.E.S.) Tail Lamp Bulb. 11^m/_m dia.

L63/600 doz. each 9d.

Plus Purchase Tax



VITALITY No. GL1 GAS LIGHTER ELEMENT

Will fit all standard type gas lighters.
L61/800 per doz. 12/-

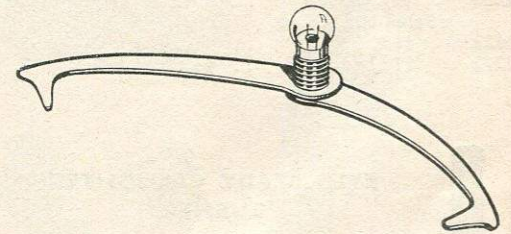

PIFCO METAL CALIPER BULB AND BATTERY TESTER

No. 1561. Measuring 9" extended.
L59/406 per doz. 6/-

M 53

W. G. CHEESE LIMITED
CYCLE AND MOTOR ACCESSORIES, WIRELESS AND ELECTRICAL SUNDRIES

JUPITER HOUSE
326-327, BRADFORD ST., BIRMINGHAM, 5
Telephone: MIDland 5804/5 (2 lines)

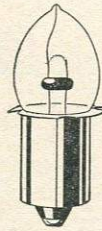
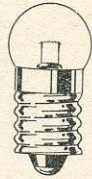

PIFCO FLASHLIGHT BULBS (EMPIRE)
L75/K

Cat. No.	Volts	Amps.	Sizes	Description	Carton Quantity	Retail Each	Purchase Tax
531/1101	1.5	.2	11 ^m / _m	Clear Spot M.E.S.	100	2d.	1 ¹ / ₂ d.
1636/1101	2.5	.3	11 ^m / _m	Clear Spot M.E.S.	100	2d.	1 ¹ / ₂ d.
1637/1101	3.5	.3	11 ^m / _m	Clear Spot M.E.S.	100	2d.	1 ¹ / ₂ d.
521/2010	1.5	.22	9 ^m / _m	Lens End M.E.S.	100	3 ³ / ₄ d.	1 ¹ / ₂ d.
522/2010	2.5	.3	9 ^m / _m	Lens End M.E.S.	100	3 ³ / ₄ d.	1 ¹ / ₂ d.
1530/2203	2.5	.3	11 ^m / _m	Clear Solid M.E.S.	100	4d.	1d.
1535/2010	2.5	.3	11 ^m / _m	Green Glass M.E.S. for heat controlled irons	100	3 ³ / ₄ d.	1 ¹ / ₂ d.
1522/3409	2.4	.5	12 ^m / _m	Prefocus	12	6 ¹ / ₄ d.	1 ¹ / ₂ d.
1532/3409	3.6	.5	12 ^m / _m	Prefocus	12	6 ¹ / ₄ d.	1 ¹ / ₂ d.



EVER READY CYCLE DYNAMO BULBS
L76/K

Cat. No.	Description	Volts	Amps.	Packing		List Price	
				Carton	Fibre Board Case	Bulb	Purchase Tax
2620	Dynamo Head M.E.S. Cap 15 ^m / _m round	6	.2	50 assorted 10 in a tray of each type	1000	8d.	1 ¹ / ₂ d.
2630	15 ^m / _m round	6	.3		1000	8d.	1 ¹ / ₂ d.
2650	15 ^m / _m round	6	.5		1000	8d.	1 ¹ / ₂ d.
2604	Dynamo Tail M.E.S. Cap 11 ^m / _m round	6	.04	Each type also available in carton of 10	1000	8d.	1 ¹ / ₂ d.
2610	11 ^m / _m round	6	.10		1000	8d.	1 ¹ / ₂ d.
2623	Panel M.E.S. Cap 11 ^m / _m	6.2	.3	10	1000	7d.	1d.
2272	11 ^m / _m	6.5	.3	10	1000	7d.	1d.



EVER READY GASLIGHTER BURNER

No. 2247/2. Spare Burner for Gaslighter. 1.5 volts.
L77/100 ... each 1/6

Free from Purchase Tax

LAMP GLASSES
Flat, Clear

L90/200 doz. 2¹/₄" ... each 3d.
L91/203 doz. 2³/₈", 2¹/₂" ... each 3¹/₂d.
L92/306 doz. 3", 3¹/₂" ... each 5d.

Red Plastics

L94/300 doz. 2¹/₄" ... each 4¹/₂d.

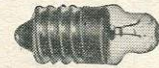

EVER READY TORCH BULBS

No. 2225. Lens End.
L78/408 doz. ... each 7d.
Plus Purchase Tax 1d.

EVER READY LAMP TOPS

L79/100 ... each 1/6



LUCAS SPARE BULBS

No. C.952 (6v. 0.5 a. M.E.S.) prefocus bulb for Pathfinder and Captain headlamps.
L80/504 doz. ... each 8d.
Plus Purchase Tax 2d.

No. C974 (3.5v. 0.15a. M.E.S.) for Dynamo Headlamp Pilot Light and Senior Battery Set Headlamp and Tail Lamp.
L81/208 doz. ... each 4d.
Plus Purchase Tax 1d.

No. C997 (6v. 0.5 a. M.E.S.) for other Dynamo ... each 8d.
2d.

No. C998 (6v. 0.1a. M.E.S.) for all Dynamo Tail Lamps.
L83/504 doz. ... each 8d.
Plus Purchase Tax 2d.

No. C202 (6v. 0.3a. S.B.C.) for old type Dynamo Headlamps.
L84/1008 doz. ... each 1/4
Plus Purchase Tax 3¹/₂d.

No. C203 (6v. 0.5a. S.B.C.) for old type Dynamo Headlamps.
L85/1008 doz. ... each 1/4
Plus Purchase Tax 3¹/₂d.

No. C205 (6v. 1a. S.B.C.) for Headlamps on Power Assisted Cycles.
L86/1208 doz. ... each 1/7
Plus Purchase Tax 4d.

No. C982 (6v. 0.3a. M.E.S.) for Tail Lamps on Power Assisted Cycles.
L87/504 doz. ... each 8d.
Plus Purchase Tax 2d.

No. C970 (2.5v. 0.2a. M.E.S.) for Junior Battery Set Headlamp and Tail Lamp.
L88/208 doz. ... each 4d.
Plus Purchase Tax 1d.

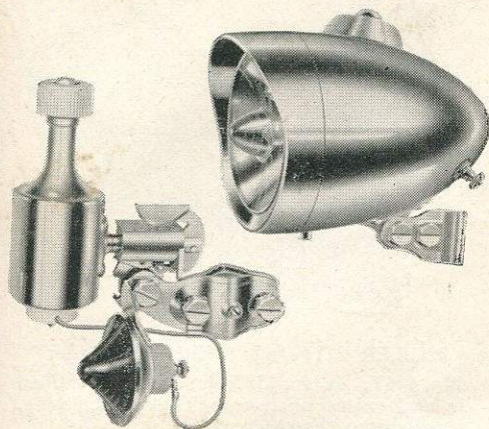

LUCAS DYNAMO

With polished aluminium body, non-skid, non-wear pulley and self-lubricated bearings. 3.6 watts output. Universal fixing bracket with positive "push" release stud for the "on" position.

Dynamo only.

L131/1300 each 19/6

Dynamo with combined CT78 Tail Lamp.

L132/1508 each 23/6

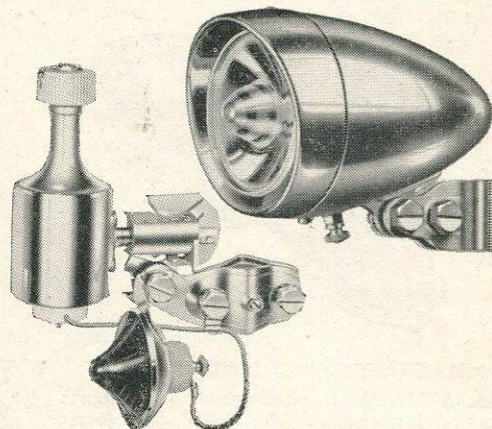

LUCAS "CAPTAIN" DYNAMO SET

Chromium-plated hooded headlamp, fitted with prefocus bulb. Front is quickly detachable and the coned centre glass lens projects an intense spot beam. Single cable wiring and outside terminals for accessibility. The set includes the No. 2 CD36 Dynamo and a streamlined Tail Lamp No. CT78.

Dynamo Set complete in chromium finish or colours.

L144/2304 each 35/-

No. HC13. Headlamp only in chromium finish or colours.

L145/1000 each 15/-

LUCAS "PATHFINDER" DYNAMO SET

Incorporates new headlamp of large proportions. Blue tinted lens with coned centre. Positive action rotary switch. Provision for stand-by battery. Supplied complete with combined 2CD Dynamo and CT78 Tail Lamp.

L123/3304 Chromium plated complete 50/-

L124/1704 HC14 Headlamp only ... 26/-

L125/3000 Silver finish complete 45/-

L126/1400 HC14 Headlamp only ... 21/-

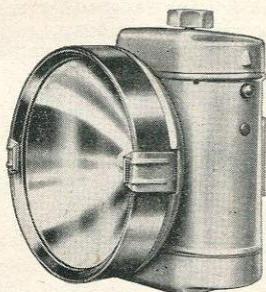

PHILLIPS "EXCELITE" FRONT LAMP

No. TE522. Chrome rim with 3" reflector and screwdown switch. Case finished in lustrous silver.

L135/406 each 6/9



LUCAS TAIL LAMP

No. CT78. A stay fixing lamp complying with 1959 regulations and made to B.S.I. Specifications.

L129/208 each 4/-

BIBIA DYNAMO PULLEY RUBBERS

L136/206 per doz. 4/-

L137/Trade per 50 10/6

PETERS LAMP BRACKET

Handlebar fitting. Chrome plated.

L138/1800 per doz. 27/-

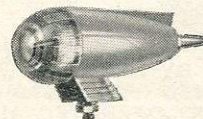

LUCAS MOULDED MINILAMP

Supplied in a range of colours: Red, Blue, Green, Yellow, Grey, Black and White. Less bulb.

L147/304 each 5/-

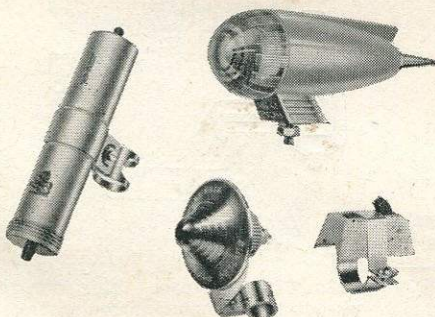

LUCAS JUNIOR BATTERY CASE SET

No. 678. Comprises Front and Rear lamps, Switch and Battery holder.

L121/1000 complete 15/-

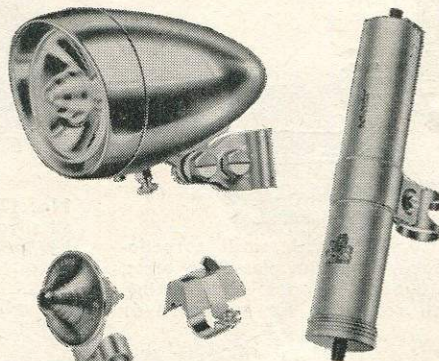

LUCAS SENIOR BATTERY CASE SET

No. 1387. Comprises Front and Rear lamps, Switch and Battery holder.

L140/2000 complete 30/-

A 19

W. G. CHEESE LIMITED
CYCLE AND MOTOR ACCESSORIES, WIRELESS
AND ELECTRICAL SUNDRIES

JUPITER HOUSE
326-327, BRADFORD ST., BIRMINGHAM, 5
Telephone: MIDland 5804/5 (2 lines)

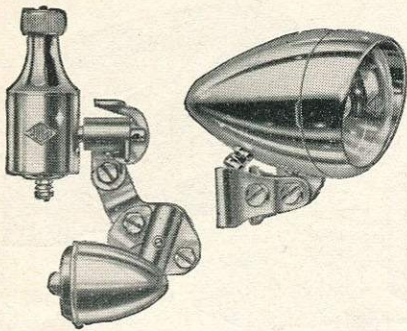

MILLER DYNAMO LIGHTING SET

No. 535T. With ultra-lightweight "Sports Torpedo" headlamp, 2½" dia. × 3⅝", 6-volt 3·24 cap. Dynamo. Combined Tail Lamp and Dynamo. Bracket designed for rear wheel fitting. Chrome finish.

L157/3304 per set 35/-

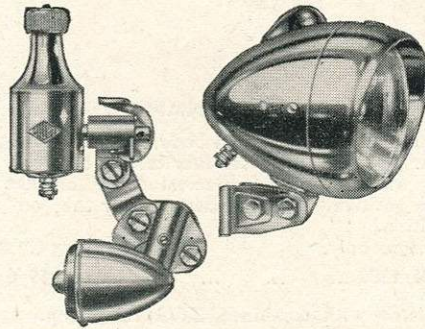

MILLER DYNAMO LIGHTING SET

No. 537T. Headlamp 3¾" dia. × 5⅛", fitted with two 0·5 amp. gas filled bulbs and with accommodation for a stand-by battery. 6-volt 3·24-watt cap. Dynamo. Combined Tail Lamp and Dynamo Bracket designed for rear wheel fitting. Chrome finish on brass.

L162/3000 per set 45/-

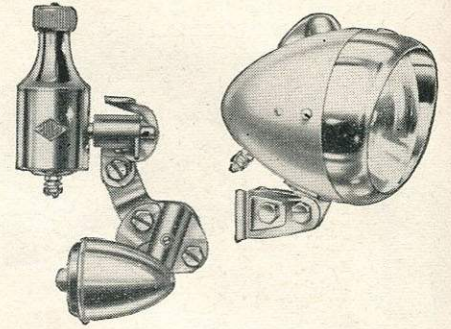

MILLER DYNAMO LIGHTING SET

No. 536T. As No. 537T, but headlamp finished in black enamel or silver grey with chrome rim, and dynamo chrome on brass.

L170/2608 per set 40/-

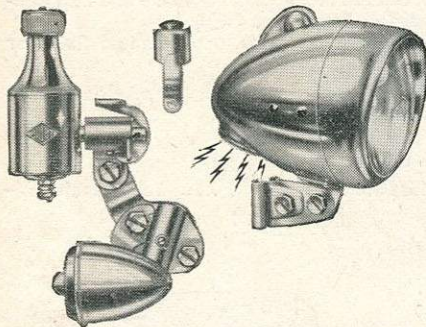

MILLER DYNAMO SET WITH COMBINED HEADLAMP AND BATTERY-OPERATED HORN

No. 537T/H. Chromium plated (less battery). L158/3304 per set 50/-

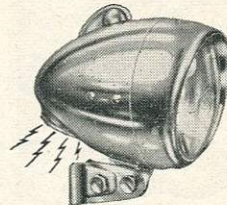

MILLER COMBINED DYNAMO HEADLAMP AND HORN

No. 7/H. (Less battery.) Headlamp 3¾" dia. × 5⅛" deep incorporates styled vizor front and is fitted with two 6-volt 0·5-amp. bulbs.

L163/1800 each 27/-

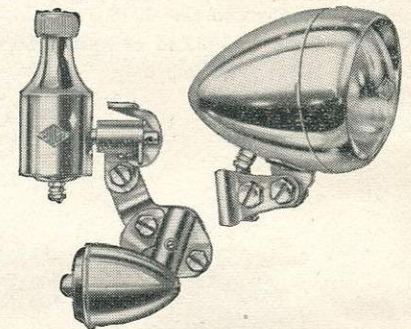

MILLER DYNAMO LIGHTING SET

No. 539T. Lightweight set, finished chromium plate on brass. The headlamp measures 3" dia. × 4⅜". 6-volt 3·24-watt cap. dynamo.

L171/2500 per set 37/6

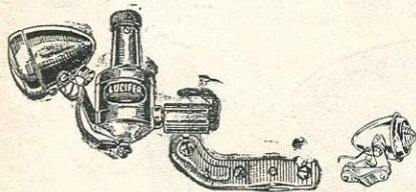

LUCIFER DYNAMO SETS

Made in Switzerland

No. 807F. Combi. With small torpedo-shaped headlamp, chromium plated on brass, attached to dynamo. Front fork fitting. Complete with rear light for mudguard or stay fitting.

L159/3000 per set 45/-

No. 809. As above, but separate headlamp that takes battery.

L160/3500 per set 52/6

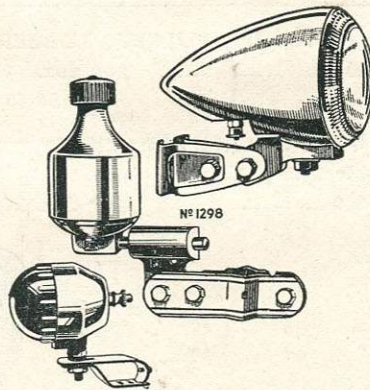

STARLITE DYNAMO SET

No. 1298. Silver finish plastic headlamp and all silver finish dynamo.

L165/1802 per set 27/3

IMPEX DYNAMO SETS

Standard 8-pole set with silver headlamp.

L166/2000 each 29/11

Combi-sport. The newest lightweight.

L167/1908 each 29/6

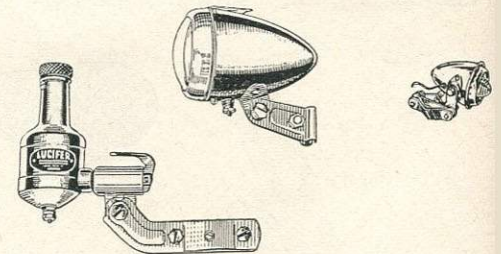

LUCIFER DYNAMO SETS

Made in Switzerland

No. 820A. Aero. With streamlined shape headlamp chromium plated on brass with type "A" English standard fitting bracket. Complete with rear light for mudguard or stay fitting bracket.

L172/3000 per set 45/-

A 10 16

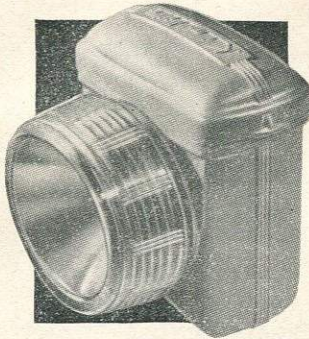

"KIMLITE" PLASTIC FRONT LAMP

Made of Polythene with Polystyrene lens. Rustless and available in black or silver colour
L235/302 each 4/9

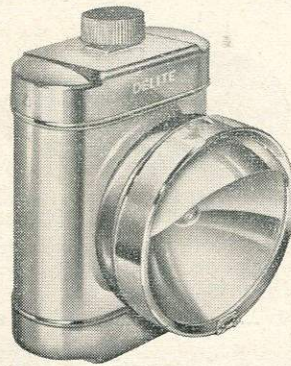

DELITE FRONT LAMP

No. 890CH. Chromium plated with 2.5v. .3A. bulb to fit twin-cell battery. 2½" reflector with visor.
L241/300 each 4/6

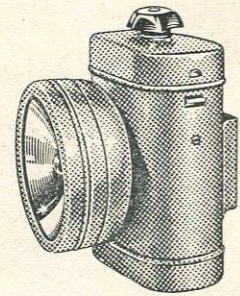

STARLITE FRONT LAMP

No. 1085. Silver.
L250/3206 doz. each 4/1

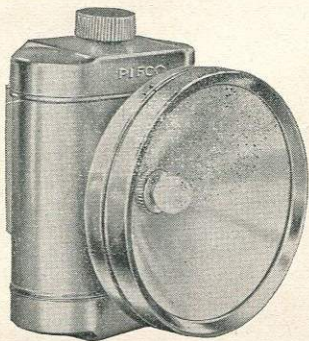

PIFCO "GIANT HEAD" CYCLE HEADLAMP

No. 1140. All chrome headlamp with large 3½" diameter head. Screw-off front with highly polished reflector. Grey milled screw-down switch. Bulb fitted: 2.5 volt Spot. Battery used: Standard twin-cell. Dimensions: 4¼" x 3¾" x 3". Weight: 7 ozs.
L237/308 each 5/6
 Batteries extra 1/4

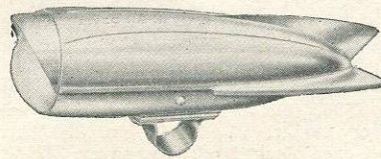

PIFCO "SILVER JET" CYCLE HEADLAMP

No. 1142. Super streamlined headlamp with all chrome body and tail fins. Hinged lid and handlebar mounting bracket. 2" diameter domed plastic lens with polished reflector and chrome vizor. On-Off slide switch. Bulb fitted: 2.5 volt Spot. Battery used: Two large unit cells. Dimensions: 9" x 2½" x 3". Weight: 10½ ozs.
L243/507 each 8/4
 Batteries extra 1/2

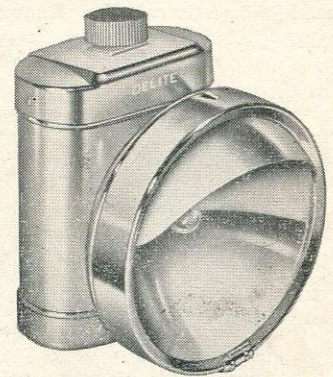

DELITE FRONT LAMP

No. 893CH. Super-de-luxe model. All brass, chromium plated with 2.5v. .3A. bulb, correctly focussed, to fit twin-cell battery. ¾" reflector with visor.
L252/604 each 9/6



THE "GREAT DELITE" DYNAMO SET
No. 227C. Brass chromium plated. Supplied as a boxed set.
L248/1804 each 27/6

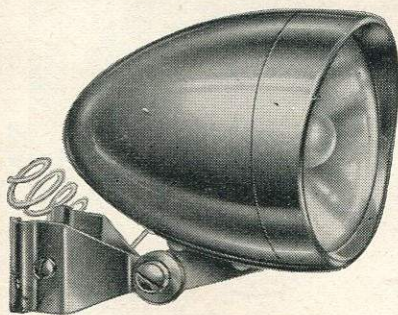

DELITE DYNAMO HEADLAMP

No. 227. Brass chromium plated 2½" reflector. With 6 volt .5 amp. bulb and cable.
L239/500 each 7/6

DELITE DYNAMO

8-Pole construction for constant light output, brass chromium-plated body, self-lubricating bearings.
L247/1106 each 17/3

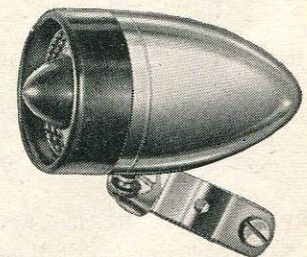

DELITE DYNAMO REARLAMP

No. 705. Chromium plated. Reflector type red lens. With 6 volt .04 amps. bulb.
L254/110 each 2/9

Y B 34

W. G. CHEESE LIMITED
 CYCLE AND MOTOR ACCESSORIES, WIRELESS
 AND ELECTRICAL SUNDRIES

JUPITER HOUSE
 326-327, BRADFORD ST., BIRMINGHAM, 5
 Telephone: MIDland 5804/5 (2 lines)



EVER READY CYCLE FRONT LAMP

No. 2306. Metal construction, with rotary switch. 2 1/4" dia. reflector. Enamelled Black, Blue, Green or Silver. Case and bulb only.

L272/210 each 4/3

EVER READY CYCLE FRONT LAMP

No. 2307. Dimensions: Length, 2 1/2" x width, 2 3/8" x height, 3 3/4". Takes No. 800 battery. Case finished in black or silver. Two-pole slide switch. 2 1/4" diameter reflector. Fixed bracket.

L273/302 each 4/9

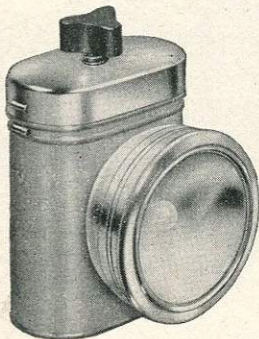

PIFCO CYCLE HEADLAMP

No. 1138. Two-tone headlamp—Golden anodised body with polished aluminium head and top cap. Screw-off 2 3/4" diameter front with chrome plated reflector. Triangular screw-down switch. Bulb fitted: 2.5 volt Spot. Dimensions: 3 3/4" x 2 3/4" x 2 3/4".

L275/208 each 4/-

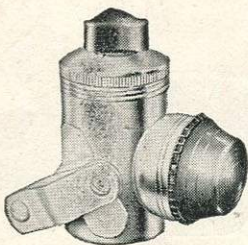

PIFCO CYCLE REAR LAMP

No. 1225. Vertical golden anodised body with polished front and top cap. 1 1/2" dia. domed red lens. Triangular screw-down switch. Adjustable fixing bracket. Bulb fitted: 1.5 volt Spot. Dimensions: 3 1/2" x 2 1/2" x 2 1/2".

L277/2600 doz. each 3/3

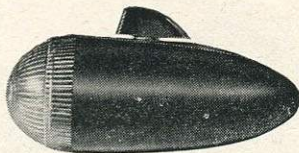

EVER READY REAR CYCLE LAMP

No. 2340. Plastic case with a metal fixing bracket. 1 1/8" dia. lens, rotary type switch. Case and No. 1427 bulb.

L291/300 each 4/6



EVER READY CYCLE FRONT LAMP

No. 2536. Dimensions: Length 2 3/8" x width, 2 7/8" x height, 4". Takes No. 800 battery. Stove-enamelled black or silver. 2 1/4" dia. reflector. Octagonal plastic lens.

L280/300 each 4/6

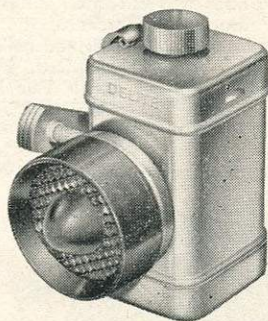

DELITE REAR LAMP

No. 714. For unit-cell battery. All chromium plated. Reflector type red lens.

L283/206 each 3/9

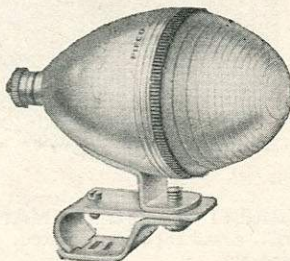

PIFCO DYNAMO REAR LAMP

No. 1218. Silver-grey finish. Red plastic 1 1/2" dia. domed ribbed lens. M.E.S. lampholder. Adjustable stay-fitting bracket. Bulb fitted: 6 volt .04 amp. Diameter: 1 3/8". Length 3 1/4".

L284/1608 doz. each 2/1



EVER READY CYCLE FRONT LAMP

No. 2236. Dimensions: Length, 3 3/4" x width, 3 1/4" x height 3 3/4". Takes No. 800 battery. Stove-enamelled black or silver. 3" diameter reflector. Front snap-on clip. Slide action switch.

L287/506 each 8/3

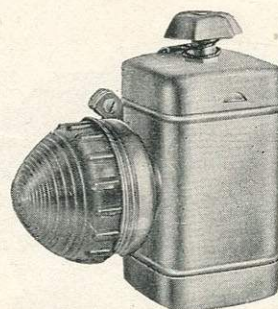

STARLITE REAR LAMP

No. 1280. Fitted with screw-down switch, 2.5 volt bulb and universal bracket for rear stay fitting. Red dome to regulation size (1 1/2"). New model superseding the old-type tubular pattern. Silver enamel finish.

L294/3200 doz. each 4/-

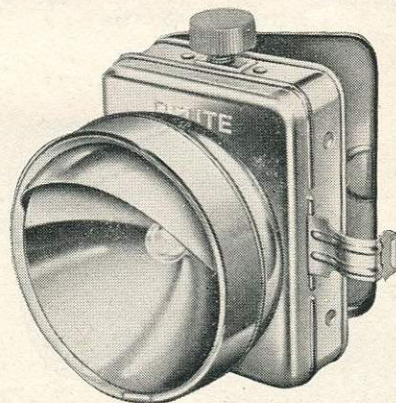

DELITE FRONT LAMP

No. 803CH. For twin-cell battery. All chromium plated. 3 1/4" reflector with visor.

L290/406 each 6/9

EVER READY SQUARE HAND LAMP



No. 5096. Length, 4½" × width, 5½" × height, 7½". Steel case finished in stove-enamelled Silver. Die-cast carrying handle. Positive sliding action switch. Unbreakable plastic lens. 4½" diameter reflector.

L348/1608 each 25/-
Plus
Purchase Tax 4/-

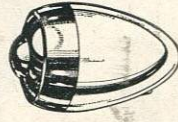

STURMEV-ARCHER REAR LAMP

No. RL6. Available with four types of clip, 5/8" dia. round, 1/2" dia. round, oval or D-shape. **Bulb No. GL598.**

L356/308 each 5/6



EVER READY HANDLAMP

No. 5996. Length, 7½" × width, 5¾" × height, 8". Metal body in Silver finish. Chromium fittings. Gate-type switch. 4½" diameter reflector. This lantern provides a choice of two lights: one for projecting a spot beam, and the other for diffused general lighting.

L360/2200 each 33/-
Plus Purchase Tax 5/6

STARLITE BATTERY COMBINATION SET

No. 1211. Comprising front lamp fitted with 2.5 volt bulb, rear light contact and terminal attachment. Rear lamp fitted with 2.5 volt bulb. Operated by screw-down switch on front lamp. Takes twin-cell battery. Black or Silver finish.

L349/6104 doz. each 7/8

MILLER DYNAMO HEADLAMPS

No. 5. Sports. Chromium plated. L350/800 each 12/-
No. 9. Chromium plated. L351/908 each 14/6
No. 6. With provision for stand-by battery. Silver or Black finish. L352/1108 each 17/6

MILLER No. 53R DYNAMO SPARES

Part No.	Description	Each
51-1	Pulley with Nut	1/1
52-1	Shimwashers	1½d.
53R-5	Top Bracket, complete with Bearing	2/6
53R-6	Rotor	7/2
53R-7	Pivoting Spindle, Shield and Body	3/10
52/8	Release Lever	4½d.
52/9	Spring Cover and Rivet	4½d.
52-10	Pivoting Spring	3½d.
52-11	Pivot Bracket	6½d.
52-12	Dynamo Fixing Screw	3½d.
52-13	Bracket Fixing Screws (2)	3½d.
52-14	Fixing Clip complete	2/6
52-15	Earthing Screw	1½d.
53R-19	Stator	3/4
53R-22	Terminal complete	6½d.
Dynamo No. 53. With Bracket complete		19/10

MILLER No. 598 TAIL LAMP SPARES

Part No.	Description	Each
52-24	Shell, complete with Glass, Clip and Screw	2/8
52-27	Shell complete with Glass	1/11
604	Bulb (6 volt .04 amp.)	10d.
Plus Purchase Tax		
52-25	Bulb Holder	1/1
52-26	Body Clip and Screw	10d.
Tail Lamp No. 598. Complete with bulb		5/-

MILLER Nos. 6 and 7 CYCLE HEADLAMP SPARES

Part No.	Description	Each
6/1	No. 6 Body with Spring Clip	5/-
6/1.B	No. 7 Body with Spring Clip	10/6
8/8	Spring Release Catch complete	4½d.
8/2	Front Rim only	3/7
8/3	Reflector Retaining Wires (set of three)	4½d.
6/4	Front Lens	1/1
6/5	Reflector	2/3
8/6	Main Bulb Holder (Screw type)	5½d.
8/6.B	Main Bulb Holder (Bayonet type)	10d.
6/15	Pilot Bulb Holder	3½d.
650	Pilot or Main Bulb (6 volts .5 amp.)	10d.
Screw type		
Plus Purchase Tax		
8/7	Terminal Screw complete	6½d.
6/13	Switch Lever	...
6/14	Switch complete	...
6/16	Front Rim, Lens, Reflector and Bulbs	11/7

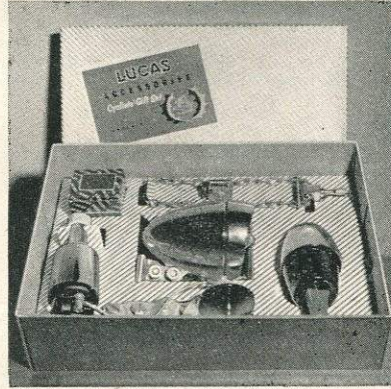

LUCAS CYCLIST'S GIFT SET

Captain Set. Contents: Captain dynamo set, 75 Comet bell, cyclometer, Gem lock and spare key with fitting instructions.

L357/3608 per set 55/-

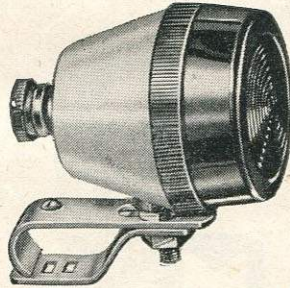

STADIUM DYNAMO REARLIGHT

No. 525. Cream coloured plastic body with 1½" diameter red lens. Two-piece adjustable rear stay clip with earthing screw. Less bulb. L358/108 each 2/6

STADIUM REARLIGHT LENS

No. 748. Diameter, 1½". For converting the smaller, older type dynamo rear light of practically any make into an up-to-date regulation rear light. L359/007 each 10d.

LUCAS CD36 DYNAMO SPARES

No. 650792. Pulley Assembly. L363/008 each 1/-
No. 204012. Bracket Operating Spring. L364/004 each 6d.
No. 204029. Bracket Assembly complete. L365/200 each 3/-
No. 204026. Bracket Loose Clip. L366/004 each 6d.
No. 655435. Bracket Bolts. L367/002 each 3d.
No. 169643. Terminal Nuts. L368/104 doz. each 2d.

LUCAS HEADLAMP SPARES

No. 655583. Bulbholder. For use on "King Minor" and "Sports" Headlamps. L369/004 each 6d.
No. 656039. Bulbholder. For use on No. HC11 "Pathfinder" Headlamp. L370/004 each 6d.
No. 655491. Light Unit. For use on "King Minor" and "Sports" Headlamps. L371/304 each 5/-
No. 177017. Bracket Nuts. For use on "King Minor", "Sports" and "Pathfinder" Headlamps. L372/104 doz. each 2d.
No. 655435. Bracket Bolts. For use on "King Minor", "Sports" and "Pathfinder" Headlamps. L373/002 each 3d.
No. 601208. Bracket Assembly. For use on "King Minor", "Sports" and "Pathfinder" Headlamps. L374/104 each 2/-
No. 656036. Reflector. "Pathfinder" Headlamp. L375/108 each 2/6
No. 656035. Glass. "Pathfinder" Headlamp. L376/008 each 1/-
No. 656040. Rubber Packing for Glass. For "Pathfinder" Headlamp. L377/008 per doz. 1/-
No. 656074. Glass Retaining Wire. For "Pathfinder" Headlamp. L378/006 per doz. 9d.
No. 656078. Front Rim Assembly. For "Pathfinder" Headlamp. L379/204 each 3/6
No. 656043. Rim Fixing Wire. For "Pathfinder" Headlamp. L380/008 per doz. 1/-
No. 656093. Switch Assembly complete. For "Pathfinder" Headlamp. L381/108 each 2/6
No. 656079. Complete Front (less bulb). For "Pathfinder" Headlamp. L382/500 each 7/6
No. 656043. Front Hinge Pin. For "Pathfinder" Headlamp. L383/008 per doz. 1/-

LUCAS CT88 REAR LAMP SPARES

No. 655526. Taper Terminal Nut. L385/004 each 6d.
No. 655546. Red Moulded Lens. L386/006 each 9d.

C 291

W. G. CHEESE LIMITED
CYCLE AND MOTOR ACCESSORIES, WIRELESS
AND ELECTRICAL SUNDRIES

JUPITER HOUSE
326-327, BRADFORD ST., BIRMINGHAM, 5
Telephone: MIDland 5804/5 (2 lines)

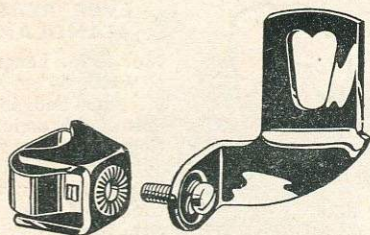

ASHBY "SPRING BAND" FRONT FORK BRACKETS

With ratchet adjustment for angle. Steel.
No. 15. For "D" Forks.
L410/1600. Enamelled black ... each 2/-
L411/2904. Chrome p.ated ... each 3/8
No. 16. For Round Forks.
L412/1600. Enamelled black ... each 2/-

ASHBY "SPRING BAND" STEEL REAR FORK AND SPINDLE BRACKET

Black or chrome-plated finish.
No. 15R. "D" Forks.
L405/1600. Enamelled ... each 2/-
L406/2904. Chrome ... each 3/8
No. 16R. Small Round Forks.
L407/1600. Enamelled ... each 2/-
L408/2904. Chrome ... each 3/8



ASHBY FRONT FORK BRACKETS
No. 18S. Plated Finish. Bracket only.
L413/2400 doz. ... each 3/-
No. 18WS. Bracket, Screw and Washer.
L414/2800 ... each 3/6

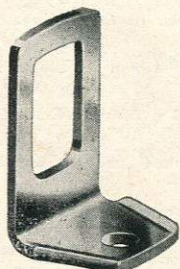

T.D.C. LAMP BRACKET
No. D25. For forward extended handlebars. Made from 10-gauge metal. Fits stem pinch bolt. Chromium plated.
L415/800 doz. ... each 1/-



ASHBY HEADLAMP BRACKET

No. 2. Standard pattern. Pierced 1" with notch. 10 Gauge.
L430/1304 doz. Chrome plated each 1/8

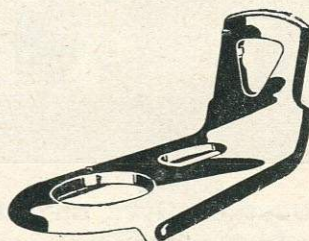

ASHBY HEADLAMP BRACKET

No. 14. "Girder" pattern. A wide and strong bracket with deep turned down sides to take the heaviest headlamps. Suits all types of head including screwed ball races. Extension 1 1/2".
L432/2208. Chrome plated ... each 2/10

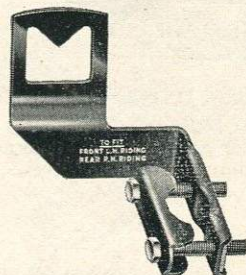

MIDLAND LAMP BRACKETS

No. 4578. Fork fitting. Front.
No. 4579. Fork fitting. Rear.
L450/100 Silver ... each 1/6
L451/110 Chromium plated ... each 2/9



ASHBY FRONT FORK BRACKET

No. 18. A clip fitting bracket with ratchet adjustment to suit all fork angles and enabling the angle of the lamp to be adjusted to individual requirements. For "D" forks. Enamelled black.
L442/2000 doz. ... each 2/6

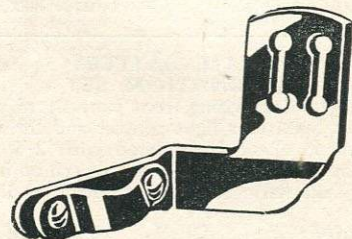

ASHBY FRONT FORK BRACKETS

No. 1. Two-screw pattern. 14-Gauge front. Available for 7/8" "D" or 5/8" round forks.
L445/904. Enamelled black ... each 1/2

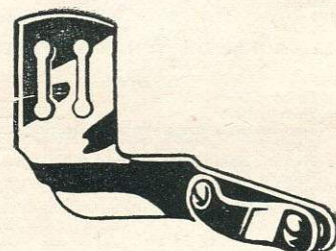

ASHBY REAR FORK BRACKETS

No. 1C. Two-screw pattern. 14-Gauge rear. Available for 7/8" "D" or 5/8" round forks.
L448/904. Enamelled black ... each 1/2



ASHBY HEADLAMP BRACKETS

No. 8. Extension pattern. In 10-gauge material with turned down sides to take heavy lamps. 1 1/2" extension.
L436/1704. Chrome plated ... each 2/2
No. 8B. As No. 8, but 3 1/2" extension.
L438/2504. Chrome plated ... each 3/2
No. 8BX. As No. 8B, but for Expander Bars.
L440/2504. Chrome plated ... each 3/2

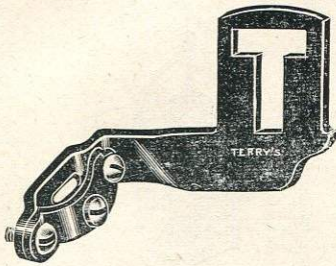

TERRY STANDARD LAMP BRACKET

No. 462. For front or rear or "D" shaped forks. A hardened pointed screw is incorporated in the clip to prevent the bracket slipping down the fork. Black enamelled.
L445/1400 doz. ... each 1/9

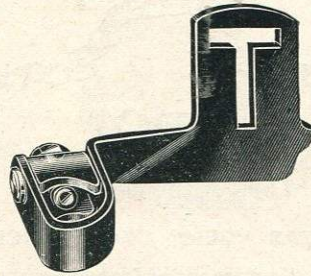

TERRY'S LAMP BRACKETS

No. 1228. For Front "D" shaped forks.
No. 1228R. For Rear "D" shaped forks.
L464/1800 Black enamelled per doz. 27/-

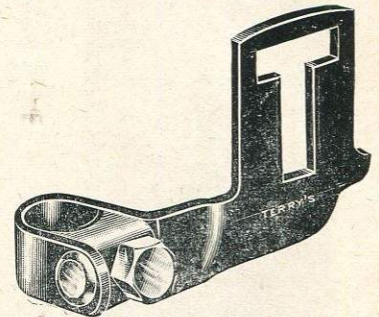

TERRY'S LAMP BRACKETS

No. 1218. For front round forks.
L478/1600 Black enamelled per doz. 24/-
No. 1218R. For rear round forks.
L479/1600 Black enamelled per doz. 24/-
No. 1298. Special bracket for Raleigh round fork, 7/8" diameter.
L480/1600 Black enamelled per doz. 24/-

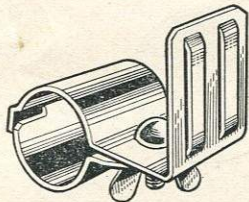

TERRY HANDLEBAR LAMP BRACKET

No. 1399. Fits 1 5/16" handlebar. Chromium plated.
L457/108 ... each 2/6

TERRY BASKET LAMP BRACKET

No. 1095A
L469/1200 doz. Silver each 1/6

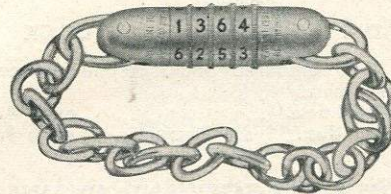

C.I. COMBINATION CODE LOCKS

Type LC/3. Consists of two halves firmly riveted to the ends of a strong welded 12" chain. Numbers 'click' and stay put. It is keyless and operated by a combination code. Chrome plated.
L470/404 ... each 6/6

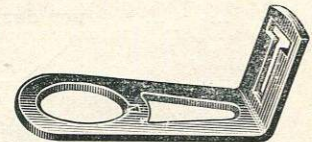

TERRY HEAD LAMP BRACKET

No. 463. Machined to exact size for fixing to cycle head. Chromium plated.
L482/1600 doz. ... each 2/-

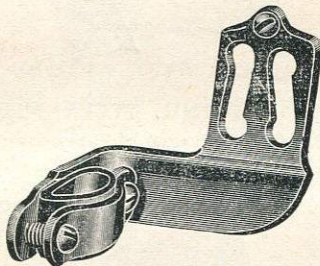

SMITH'S FORK FITTING LAMP BRACKETS

Can be supplied for round or "D" forks. Ebony black.
No. 16. Rear.
L458/608 doz. ... each 10d
No. 17. Front.
L459/608 doz. ... each 10d.

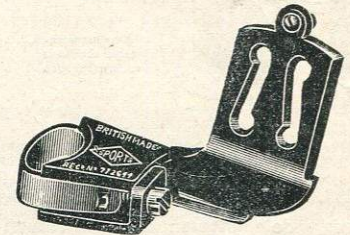

SMITH'S LAMP BRACKETS

No. 20. Front "D" Fork.
L484/1304 Silver per doz. 20/-
L485/2400 Chrome plated per doz. 36/-
No. 21. Front, Round.
L486/1304 Silver per doz. 20/-
L487/2400 Chrome plated per doz. 36/-

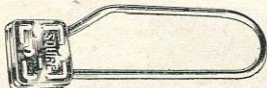

SQUIRE CYCLELOCK

No. 57. Plastic covered shackle. 1 1/2".
L472/300 ... each 4/6

SQUIRE LOCKS

No. 518. Goliath. Heavy duty chain lock for Mopeds, Bicycles and Motor Cycles. Plastic covered chain.
L474/310 ... each 5/9

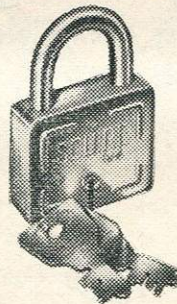

SQUIRE WARED LEVER PADLOCKS

Wrought steel cases, rib-protected steel rivets, self-locking steel shackles. Pure zinc plated. Two milled steel keys.
L460/2304 doz. No. 04. 1 1/4" each 2/11



SQUIRE WELDED STEEL CHAIN

No. 30C. 12" long.
L476/800 doz. ... each 1/-

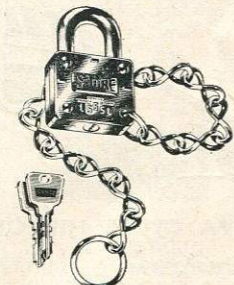

SQUIRE CYCLELOCK

No. 60. Double locking mechanism. Pure zinc plated, 2 keys. 12" welded steel chain.
L489/206 ... each 3/9



LACRINOID POLYTHENE OILCANS

No. 1. Transparent, providing visual check on the oil level. Non-rusting, flexible and unbreakable.

L492/500 per doz. 7/6

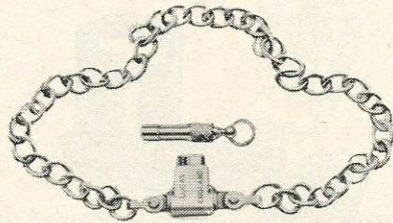

LUCAS "GEM" CYCLE LOCK

No. 104. Keys are varied for additional safety. Chromium-plated finish.
L493/308 each 5/6



KINGSTON OIL CAN

All polythene oil bottle with cap-protected nozzle.
L510/06 each 9d.

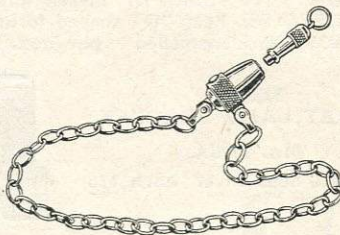

ADIE "ACORN" CYCLE LOCK

No. 101. Coloured body, chromium-plated key and chain.
L495/3400 doz. each 4/3
L496/600 doz. Spare keys each 9d.

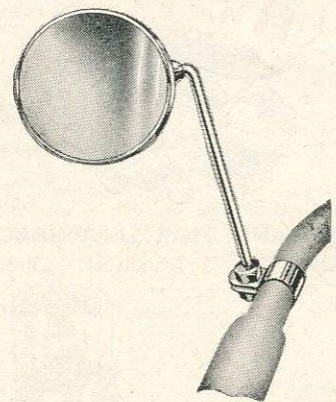

STADIUM ROUND CYCLE MIRROR

No. 288. With Universal ball joint for adjustment to any angle. Length of arm, 6". Dia. of mirror, 3½".
M18/404 each 6/6

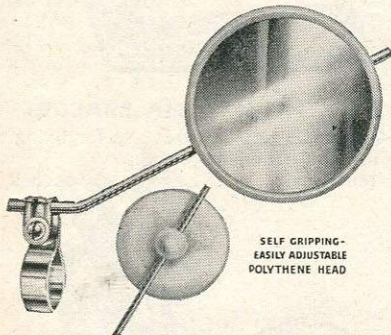

SELF CRIPPING-EASILY ADJUSTABLE POLYTHENE HEAD

STADIUM ROUND CYCLE MIRROR

No. 285. With Polythene Head. Swivel clip gives wide adjustment. Length of arm 6½", dia. of mirror, 3".

M10/200 each 3/-

POPULAR LOCKS AND CHAINS

No. 1000.
L498/104 each 2/-



TECALEMIT GREASE NIPPLES

No. NC6056. ⅜" × 32T.P.I.
L499/407 per doz. 6/6

No. NC6050. ¼" B.S.F.
L500/1006 per doz. 15/-

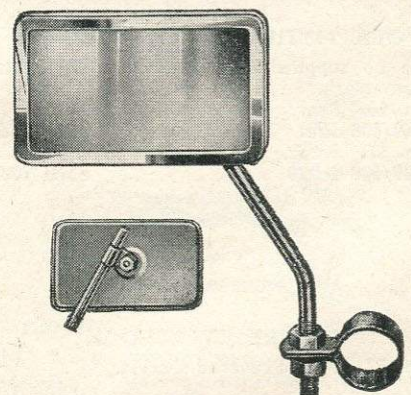

STADIUM OBLONG CYCLE MIRROR

No. 290. With plated front rim and silver back. Curved wide vision mirror glass. Fully adjustable to any angle. Brackets to fit all standard handlebars. Length of arm, 6¼". Size of mirror, 3½" × 2⅜".
M20/500 each 7/6

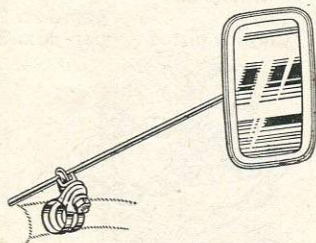

NOVA CYCLE MIRRORS

Chromium plated.

M14/208 each 4/-

APEX MIRRORS

Real view round mirror. Strong clip.

M16/300 each 4/6



ALBION SPRING LID LUBRICATORS

No. 1307.
L504/109 doz. ⅜" Thread each 3d.
L505/109 doz. ½" Thread each 3d.

"LYVIA" CYCLE HANDLEBAR MIRRORS

M11/200. **No. 135.** Round each 3/-
M12/204. **No. 136.** Round each 3/6
M13/208. **No. 139.** Oblong each 4/-

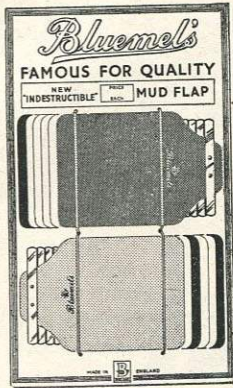

**BLUEMEL'S No. 1
"INDESTRUCTIBLE" MUDFLAPS**

No. 1650c. Flexible plastic reinforced fabric material with high gloss in black and a range of colours.
M50/1400 doz. ... each 1/9



BROOKS TYPE MUDFLAPS

No. 2292. With double-riveted clips. Specially shaped to give extra support. Available in black or white.
M52/102 ... each 1/9



**BLUEMEL'S
"OLYMPIC" MUDGUARDS**

No. 1663. Supplied with the new micro-adjustment stays and fittings, black or white. For 26"/28" wheels.
M54/1100 ... per pair 16/6



**BLUEMEL'S
"GOLD MEDAL" MUDGUARD**

No. 1664. Celluloid or plastic, with the new micro-adjustment stays and fittings. Black or white. For 26"/28" wheels.
M56/908 ... per pair 14/6



**BLUEMEL'S No. 2
"INDESTRUCTIBLE" MUDFLAPS**

No. 1651. Made in the same reinforced material as the No. 1, but in a larger size giving greater protection.
M58/2000 doz. ... each 2/6



DUNLOP MUDGUARD FLAPS

Type MF/1. Hook-on Type (to stays).
M60/3600 doz. ... each 4/6



JOHN BULL MUDFLAPS

Large size for front guards. Clip on to stays. Black.
M62/3600 doz. ... each 4/6

TRICYCLE MUDGUARDS

White, set of 3. Steel.
M65/507 14" and 16" ... per set 8/5
M66/507 18" ... per set 8/5



MIDLAND CYCLE MUDSPLASHERS

Plastic. Assorted colours (12 per card).
M67/100 No. 491. 9 1/2" x 8 1/2" each 1/6
M68/100. No. 674. 7 1/4" x 5 3/4" each 1/6
Tuffide (24 per card).
M69/200. No. 491/T. 9 1/2" x 8 1/2" each 3/-
M70/100. No. 674/T. 7 1/4" x 5 3/4" each 1/6

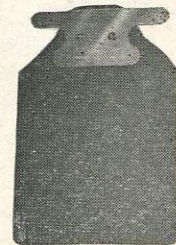

DUNLOP MUDGUARD FLAPS

No. MF/2. Clip-on type (to guard).
M72/3200 doz. ... each 4/-

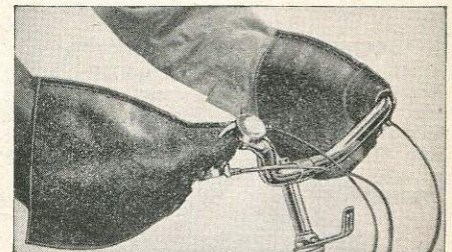

MIDLAND HANDLEBAR MUFFS

No. 1304. Fit over handlebar and brake lever and lace securely. Made from waterproof leathercloth material, fleece lined.
M74/708 ... per pair 11/6



**BLUEMEL'S
"TUFLITE" MUDGUARDS**

Cadmium plated steel stays and bridges. White only. Spearpoint or full width expansion.
M76/908 ... each 14/6

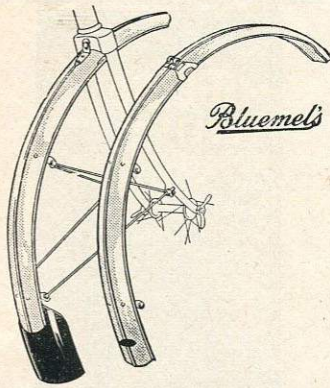

BLUEMEL'S "AIRWEIGHT" ALLOY MUDGUARDS

No. 1552A. Cadmium-plated steel stays. Domed section with rib down centre. Oval Blue Nameplate. Adjustable fittings. For 26"/28" wheels.

M80/900 per pair 13/6

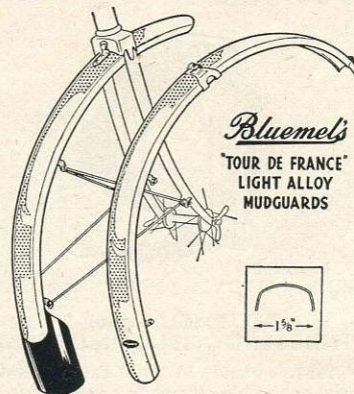

BLUEMEL'S "TOUR DE FRANCE" ALLOY MUDGUARDS

No. 1660A. Cadmium-plated steel stays. Narrow (1 3/8") deep domed section. Side valances. Oval Blue Nameplate. Adjustable fittings. For 26"/28" wheels.

M92/908 per pair 14/6

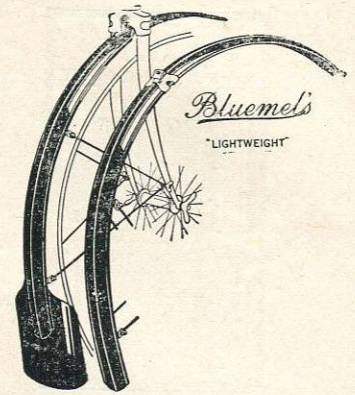

BLUEMEL'S "LIGHTWEIGHT" CELLULOID MUDGUARDS

No. 1631. For the road racing type of cycle. Domed narrow (1 3/8") section with rib down centre. Full width or spearpoint front extension. Steel wire stays and metal fittings, cadmium plated. For 26"/27" wheels. Black or White.

M108/908 per pair 14/6

Colours and Transparent. M109/1004 per pair 15/6

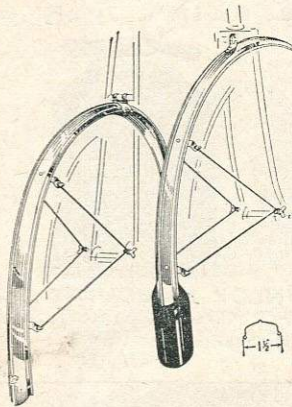

BLUEMEL'S "CONTINENTAL" ALLOY MUDGUARDS

No. 1620A. Cadmium-plated steel stays. Narrow section (1 1/2") with rib down centre. Side valances. Oval Blue Nameplate. Adjustable fittings. Black or white. For 26"/28" wheels.

M84/908 per pair 14/6



BLUEMEL'S EXTENSIONS For Front Mudguards

No. 1108. "Spearpoint" No. 6 White Celluloid. M86/1608 doz. each 2/1

No. 1639. No. 5, abbreviated mudguard in alloy. "Continental" (narrow) section. M88/109 each 2/8

No. 1640. No. 7, similar to above but in "Tour de France" (narrow) section. M89/109 each 2/8

BLUEMEL'S SPARE PARTS

For Celluloid and Alloy Mudguards

No. 1426. Box of replacement parts, each part in separate compartment with key diagram in lid. M90/Trade per box 51/9

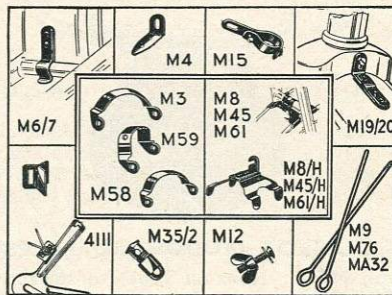

BLUEMEL'S MUDGUARD COMPONENTS

No. M8. Sliding Bridges with Clips. "Noweight", "Featherweight", "Tour de France" and "Continental". Carded in 2 dozens.

M94/Trade per doz. 4/9

No. M45. Sliding Bridges with Clips. "Lightweight" and "Continental" (narrow). M95/Trade per doz. 4/9

No. M9 Stays. Cadmium-plated steel, single, carded in 4 dozens. M96/Trade per doz. 2/8

No. MA32 Stays. Stainless steel, singles, carded in 4 dozens. M97/Trade per doz. 4/9

No. M35/2. Drawbolts (hole drilled for stay) with screw nuts, in cellophane bags of four, carded, 2 dozen bags per display card. M98/Trade per doz. bags 14/8

No. M12. Wing Nut and T-Bolt. With shakeproof washer, in cellophane bags of four, carded, two dozen bags per display card. M99/Trade per doz. bags 12/6

MUDGUARD PINS AND NUTS

		Per gross
Fine or coarse thread.		
M100/Trade	3/16" assorted	6/6
M101/Trade	3/16" x 1/2"	5/4
M102/Trade	3/16" x 5/8"	5/6
M103/Trade	3/16" x 1 1/4"	5/9
M104/Trade	3/16" x 1"	6/-
M105/Trade	3/16" x 1 1/4"	6/10
M106/Trade	3/16" x 1 1/2"	7/6

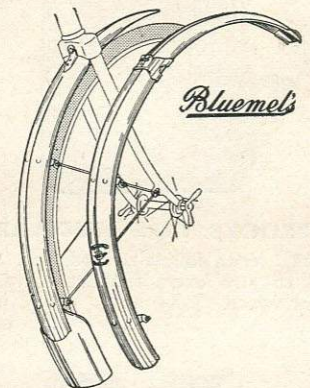

BLUEMEL'S "NOWEIGHT" CELLULOID MUDGUARDS

No. 1553. Domed section (2 1/4") with rib down centre. Spearpoint or full width front extension. For 26"/28" wheels. Black or White.

M112/908 per pair 14/6

Colours and Transparent. M114/1004 per pair 15/6

Optional Extras:—

Fitted to any of Bluemel's Mudguards.

No. 60. Rear Reflector.

M116/008 each 1/-

Wing Nuts, T-bolts and Washers.

M117/008 per set of four 1/-

Fork Clips. M118/100 per set of four 1/6

BLUEMEL'S "CLUB SPECIAL" CELLULOID MUDGUARDS

No. 1661. Deep domed narrow (1 3/8") section with rib down centre. Spearpoint or full width extension. For 26"/27" wheels. Black or White.

M120/1100 per pair 16/6

Colours and Transparent. M121/1108 per pair 17/6

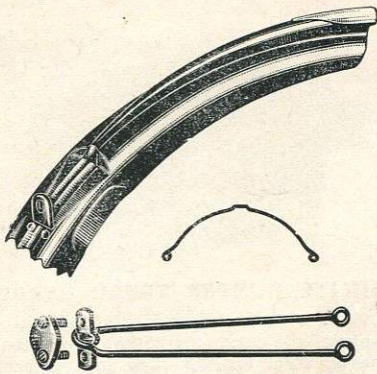

RAINMASTER JUVENILE MUDGUARDS

Ribbed crescent section. Wire stays and plate fastening.

Model P61. Juvenile. 14", 16", 18".
M160/4200 doz. prs. White per pair 5/3

Model P61. Juvenile. 20", 24".
M161/3200 doz. prs. Black per pair 4/-
M162/4300 doz. prs. White per pair 5/4

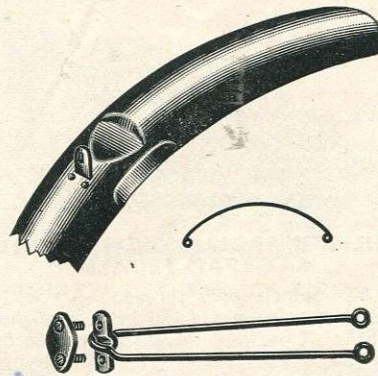

RAINMASTER MODEL P45 "CHROMENOSE" No. 1 MUDGUARDS

"R" Pattern Sports. 26". Special model with standard wire stays, plate fastenings and special "R" accessories.

M171/5400 doz. prs. Black and lined per pair 6/9
M172/6800 doz. prs. White per pair 8/6

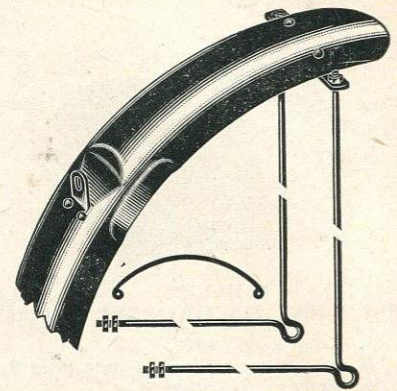

RAINMASTER CARRIER MUDGUARDS

Model V4. 2 3/4" wide section. Two bridges, nutted wire stays. 26".

M182/508 Black ... per pair 8/6

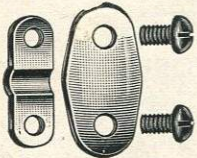

MUDGUARD PLATES WITH SCREWS

M163/406 doz. sets per set 7d.

MUDGUARD ADJUSTABLE SEAT STAY BRIDGES

M164/400 doz. Sports each 6d.
M165/400 doz. Roadster ... each 6d.

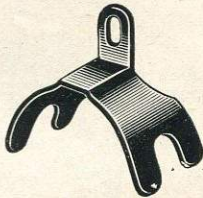

RAINMASTER SPORTS AND LIGHT ROADSTER MUDGUARDS

Model P47. Rib-dome section, 26". Chrome nose.

M174/3800 doz. prs. Black per pair 4/9
M175/5200 doz. prs. White per pair 6/6

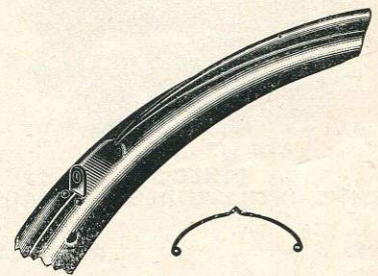

RAINMASTER MODEL P9 MUDGUARDS

Width, 2 3/16". Roadster pattern, 26" and 28". With heavy wire stays and plate fastening.

M184/3400 doz. prs. Black per pair 4/3



APEX SWALLOW MUDGUARDS

.030" Celluloid x 1 3/4" wide.
Black or White, with Reflector.
M168/802 ... per pair 12/3
Coloured.
M169/806 ... per pair 12/9

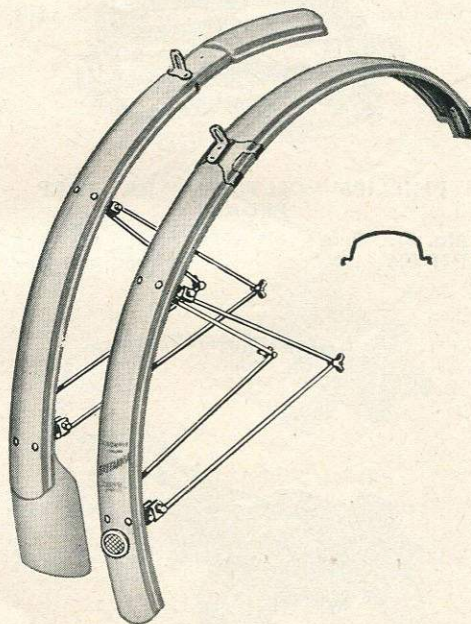

BRITTONS "BRITANNIA" WIDE WHITE RIBBED MUDGUARDS

With reflector and all fittings.
M179/808 ... per pair 13/-



APEX CELLULOID GUARDS

No. 10. Celluloid, .030" thick, 1 7/8" wide.
M186/606 White ... per pair 9/9
White or Black with Reflector.
M187/700 ... per pair 10/6
Coloured with Reflector.
M188/704 ... per pair 11/-

Y V 33

W. G. CHEESE LIMITED
CYCLE AND MOTOR ACCESSORIES, WIRELESS
AND ELECTRICAL SUNDRIES

JUPITER HOUSE
326-327, BRADFORD ST., BIRMINGHAM, 5
Telephone: MIDland 5804/5 (2 lines)

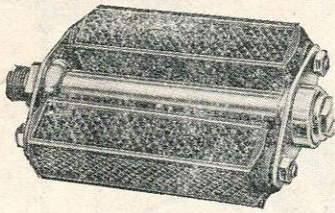

PHILLIPS' "CELTONIA" FULL-RUBBER PEDALS
 No. 65. Gent's. 4" wide.
 P26/506 per pair 8/3
 No. 66. Lady's. 3½" wide.
 P27/506 per pair 8/3

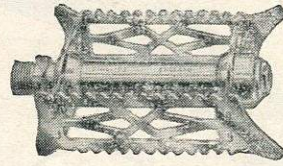

PHILLIPS' APOLLO LIGHTWEIGHT RAT-TRAP PEDALS
 No. 83. Spindle ends threaded $\frac{9}{16}$ " x 20T. Adjustable bearings and $\frac{5}{32}$ " balls throughout.
 P40/511 per pair 8/11

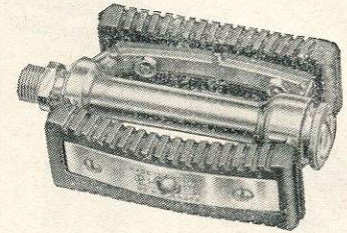

PHILITE RUBBER TREAD PEDALS
 No. 102. A lightweight rustless pedal, with one-piece die-cast aluminium alloy centre, hardened steel bearing cups and replaceable moulded rubber treads. Weight, 20 ounces per pair.
 P48/808 per pair 13/-

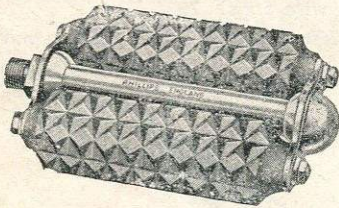

PHILCO GENT'S "FULL-RUBBER" PEDALS
 No. 97. 4¼" wide.
 P29/603 per pair 9/5
 No. 98. 4½" wide.
 P31/604 per pair 9/6



PHILITE LIGHTWEIGHT PEDALS
 No. 166. With hollow spindle and hardened steel strips fitted to wearing surfaces. Weight 13½ ounces per pair.
 P42/1009 per pair 16/2

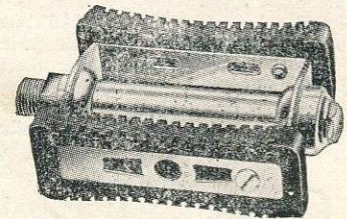

CREDALUX LIGHTWEIGHT TOURIST PEDALS
 No. 202. Two-piece pressed steel frame with replaceable rubbers. Weight, 22 ozs. per pair.
 P50/609 per pair 10/2

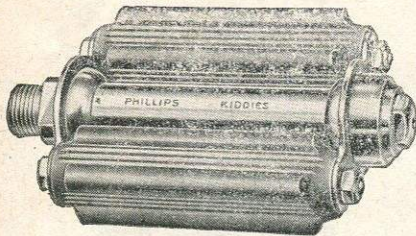

PHILLIPS' "CREDEX" KIDDIES' FULL-RUBBER PEDALS
 No. 58. 3" wide. Robust type with best quality rubbers and smooth, easy running bearings.
 P33/501 per pair 7/8

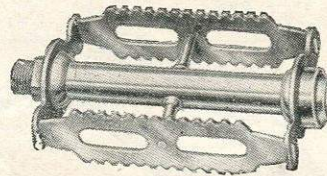

PHILLIPS' "CELTONIA" RAT-TRAP PEDALS
 No. 61. Gent's. 4" wide.
 P44/504 per pair 8/-

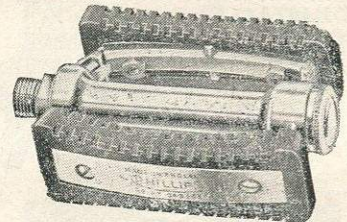

PHILITE "REFLEX" RUBBER TREAD PEDALS
 No. 157. Replaceable moulded rubber tread, one-piece centre of die-cast aluminium alloy, with reflectors on side plate of pedals. Weight, 20 ounces per pair.
 P52/903 per pair 13/11

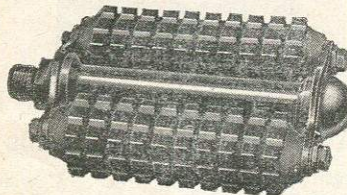

PHILLIPS' ANGLO HEAVY CARRIER PEDAL
 No. 70. 4" wide.
 P35/810 per pair 13/3

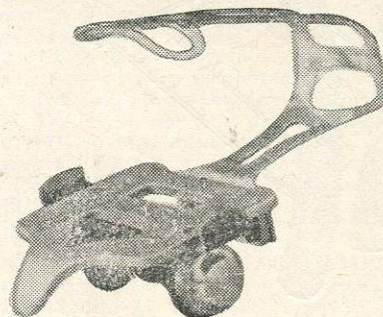

CONSTRICTOR "ASP" PEDALS
 Weight, 16 ozs. pair.
 P54/1500 per pair 22/6
 Toe clips extra.

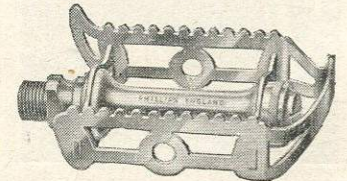

CREDALUX SOLID CENTRE RAT-TRAP PEDALS
 No. 101. For all types of Sports Bicycles. Constructed with solid centre barrel and light alloy easy-fit caps.
 P46/1011 per pair 16/5

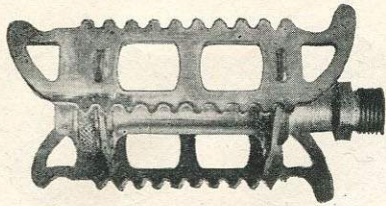

CONSTRUCTOR "VIPER" PEDAL

Weight, 14½ ozs. pair.

P80/1404 per pair 21/6

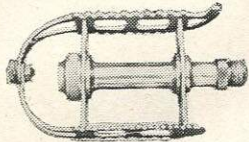

CONSTRUCTOR "COBRA" PEDAL

Weight, 15 ozs. pair.

P82/1404 per pair 21/6

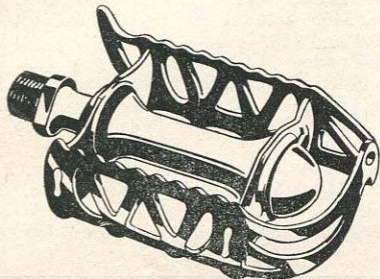

WEBB QUILL PEDALS

No. 21. Totally enclosed bearings at both ends and easily detachable dust cap, 5/32" diameter. Ball bearings retained in cage.

P84/1100 per pair 16/6

RESILION PEDALS

P85/608 Chromium plated per pair 10/-



PHILLIPS' PEDAL RUBBER BARS AND NUTS

No. P701X. Suitable for Pedals Nos. 65, 45, 125, 127 and 353.

P88/Trade per doz. 3/7

No. P702X. Suitable for Pedals Nos. 66, 46, 126, 128, 201 and 354.

P89/Trade per doz. 3/7

No. P703X. Suitable for Pedal No. 58.

P90/Trade per doz. 3/1

No. P704X. Suitable for Pedal No. 97.

P91/Trade per doz. 4/-

No. P705X. Suitable for Pedal No. 98.

P92/Trade per doz. 4/-

No. P706X. Suitable for Pedals Nos. 81 and 84.

P93/Trade per doz. 4/9

No. P718X. Suitable for Pedal No. 70.

P94/Trade per doz. 4/7

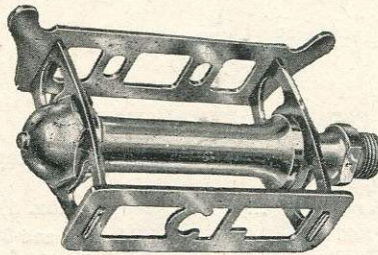

CHATER-LEA SPRINT PEDAL

No. 1690. Single sided, solid centre, stainless steel frames, nipple lubrication.

P102/2404 *2304* per pair ~~32~~ *35*

CHATER-LEA RACE PEDAL

No. 1619. Solid centre, stainless steel frames, nipple lubrication. (Not fitted with oil seals.)

P104/2404 *2304* per pair ~~32~~ *35*

WIPPERMAN PEDALS

SR51. Rat-trap. Italian style, single-sided racing chromium-plated pedals.

P106/700 per pair 10/6

WIPPERMAN PEDALS

Gent's 4" chromium-plated rubber pedals.

P107/406 per pair 6/9

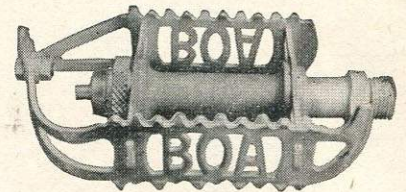

CONSTRUCTOR "BOA" PEDAL

Weight, 15 ozs. pair.

P112/1908 per pair 29/6

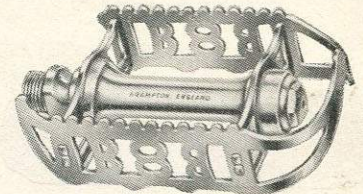

BRAMPTON SOLID CENTRE RACING PEDALS

No. B8. Size 2½" between End Plates 3¾" Tread. Provision for toe straps. Chromium plated.

P113/1011 per pair 16/6



DAWES "TWIRL" PEDALS

Very reasonably priced and well finished.

P115/900 per pair 13/6

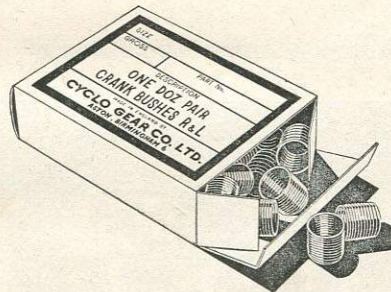

CYCLO CRANK BUSHES

No. 125B. To suit R. and L. single. Boxed in 1 dozen pairs.

P110/Trade Box 12/-

CHATER-LEA PEDAL SPINDLES

Right or left-hand.

P98/402 each 6/3

PHILLIPS' PEDAL SPINDLES

With Spindle, Cone, Locknut and Washer.

No. P127X. Suitable for Pedals Nos. 65, 61, 45, 125, 127 and 353 (4").

P118/Trade per doz. pairs 21/4

No. P133X. Suitable for Pedals Nos. 66, 46, 126, 128 and 354 (3½").

P119/Trade per doz. pairs 21/4

No. P134X. Suitable for Pedal No. 58 (3").

P120/Trade per doz. pairs 20/4

No. P140X. Suitable for Pedal No. 97 (4¼").

P121/Trade per doz. pairs 22/11

No. P141X. Suitable for Pedal No. 98 (4½").

P121/Trade per doz. pairs 24/1



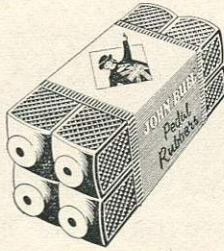

JOHN BULL CYCLE PEDAL RUBBERS
 3½" × 1". Ladies'.
P150/108 per set of four 2/6
 4" × 1". Gent's.
P151/108 per set of four 2/6



PHILLIPS' JUVENILE PEDAL RUBBERS
No. P616. Suitable for No. 58 Juvenile Pedals.
P154/Trade per set 1/1



TERRY PUMP CLIPS **P156/K**
No. 692. Inflator Clips for cycle and motor cycle.

Size	Per dozen pairs	Chromium plated
1" × 7/8"	...	30/-
1½" × 7/8"	...	30/-

PUMP CLIPS
 Standard.
P158/508 per doz. pairs 8½d.
 Juvenile.
P159/508 per doz. pairs 8½d.



BLUEMEL'S "PREMIER" CONNECTIONS
No. P9. Silko braided, 6½" long. For both Dunlop (Woods) and high pressure valves.
P162/1008 per doz. 16/-



PHILLIPS' PEDAL CONES
No. P203. Suitable for all Pedals except Nos. 70 and 81.
P164/Trade per doz. 1/8
No. P202. Suitable for Pedals Nos. 70 and 81.
P166/Trade per doz. 2/7

PHILLIPS' PEDAL RUBBER BAR NUTS

No. N601. Suitable for all Pedals. Cadmium.
P168/Trade per gross 3/3
No. N610. Locknut. Suitable for Pedals Nos. 70, 81 and 84.
P169/Trade per gross 6/-

PHILLIPS' SPINDLE LOCKNUTS

No. N1003. Suitable for all Pedals except Nos. 70 and 81.
P172/Trade per doz. 8d.
No. N1013. Suitable for Pedals Nos. 70 and 81.
P173/Trade per doz. 9d.

PENNANTS

A wide range of felt pennants with standards, nuts and clips for handlebar fitting, depicting Cycle and Motor Cycle, Football Clubs, Skull and Cross Bones, Red Devil, Union Jack.
P176/1100 doz. each 1/6

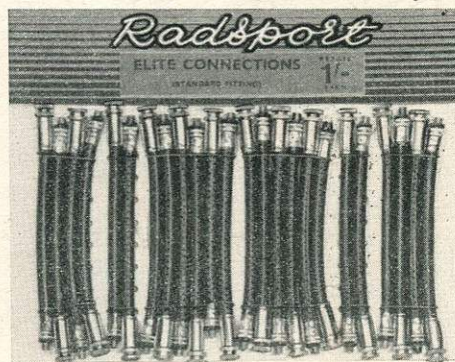

"RADSPORT" ELITE CONNECTIONS
 Standard. 24 per card.
P178/1404 each 1/-
 H.P. 24 per card.
P179/1404 each 1/-

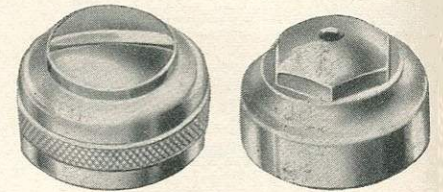

BRAMPTON PEDAL DUST CAPS
P180/208 doz. No. B323 4d.
P181/709 doz. No. B324 1/-



PHILLIPS' PEDAL DUST CAPS
No. P515. Suitable for Pedals Nos. 58, 61, 65, 66, 83, 97, 98, 125, 126, 191 and 202.
P183/Trade per doz. 2/8
No. P516. Suitable for Pedals Nos. 45, 46, 55, 101 and 166.
P184/Trade per doz. 7/9
No. P518. Suitable for Pedals Nos. 102., 157
P185/Trade per doz. 7/9
No. P504. Suitable for Pedals Nos. 70, 81 and 84.
P186/Trade per doz. 3/11
No. P514. Suitable for Pedals Nos. 353 and 354.
P187/Trade per doz. 4/7

CONSTRUCTOR PEDAL CAPS

P189/106 each 2/3

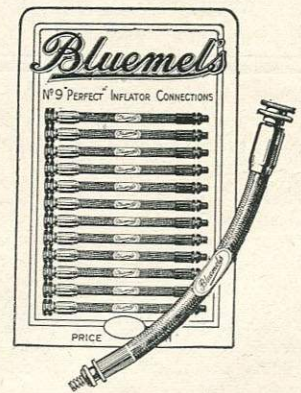

BLUEMEL'S INFLATOR CONNECTIONS
No. 9/9A. Universal Pattern, 5½" for standard Woods, and high pressure valves.
P192/800 per card each 1/-

Y D 24

W. G. CHEESE LIMITED
 CYCLE AND MOTOR ACCESSORIES, WIRELESS
 AND ELECTRICAL SUNDRIES

JUPITER HOUSE
 326-327, BRADFORD ST., BIRMINGHAM, 5
 Telephone: MIDland 5804/5 (2 lines)



"RADSPORT" CELLULOID PUMPS

Guaranteed 100%

- P201/210 9" White ... each 4/3
- P202/210 12" White ... each 4/3
- P203/3108 doz. 15" White ... each 3/11
- P204/3108 doz. 15" Black ... each 3/11



BAILEY'S "SUPER" PUMPS

All pumps fitted with 5 1/2" Connections. Steel-lined celluloid covered, 15" x 7/8".

- P208/400. Black or White ... each 6/-
- P209/404. Coloured ... each 6/6

Aluminium-lined celluloid covered, 15" x 7/8".
 P210/404. Black or White ... each 6/6
 P211/408. Coloured ... each 7/-
 12" Pumps, Less 6d. 18" Pumps, Extra 6d.

We can arrange for customer's name to be marked on Bailey "Super" and celluloid pumps for minimum quantities of 36, free of charge. Maximum number of characters, 32.



APEX "GRAND PRIX" ALUMINIUM ALLOY PUMPS

Fitted with three coloured rings on barrel and 7" high-pressure connection. 18" x 1 5/8".

- P214/606 Metallic colours ... each 9/9
- P215/600 Polished ... each 9/-



APEX "ULTRALITE" PUMP

Polished, with solid zinc plated plunger tube.
 P216/302 15" x 7/8" ... each 4/9
 P217/306 18" x 7/8" ... each 5/3
 As above plus 3 colour rings on barrel and 7" high pressure connection.

- P219/310 18" x 7/8" ... each 5/9
- P220/306 15" x 7/8" ... each 5/3

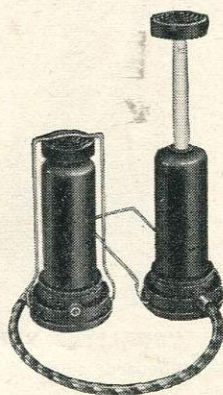

AIREZE CYCLE FOOT PUMP

Major Model. Overall height, 5 3/4". Fitted 12" connector with a removable adaptor making the pump suitable for either Cycle or Schrader-type Valves.

- P226/510 ... each 8/9
- P227/404 Standard Model ... each 6/6



APEX "ULTRALITE" RACER PUMP

Cone-shaped ends. With 3 coloured rings on barrel. Zinc plated plunger tube. 7" connection.

- P228/404 Polished ... each 6/6
- P229/502 Coloured ... each 7/9



APEX "SUPERLITE" CELLULOID PUMPS

With solid plated Plunger Tube. 5 1/2" Connection.

- P232/304. 15" x 7/8" Black or White each 5/-
- P233/308. 15" x 7/8". Colours ... each 5/6
- P234/300. 12" x 7/8". Black or White each 4/6
- P236/304. 12" x 7/8". Colours ... each 5/-
- P237/308. 18" x 7/8". Black or White each 5/6
- P238/400. 18" x 7/8". Colours ... each 6/-



APEX STEEL PUMPS

With split-steel plunger tube. 15" x 7/8". 5 1/2" Connection. Black or White enamel finish.

- P239/206 ... each 3/9

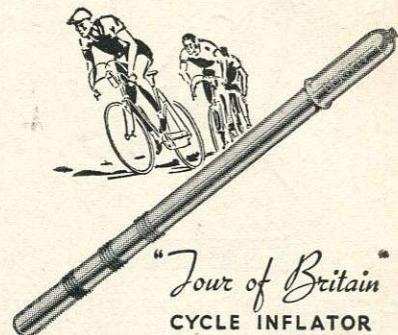

"Tour of Britain"
BLUEMEL'S "TOUR OF BRITAIN" ALLOY PUMPS

No. 1728. Polished. 18" x 1".

- P248/700 ... each 10/6

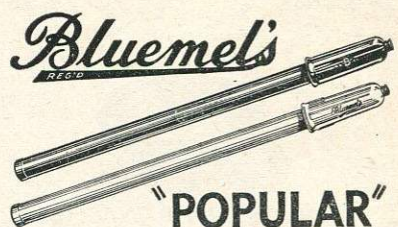

Bluemel's
"POPULAR" INFLATORS

BLUEMEL'S "POPULAR" PUMPS

- No. 1736. Plastic. 15" x 7/8". Black or White. P250/304 ... each 5/-
- No. 1736C. Plastic. 15" x 7/8". Coloured. P251/308 ... each 5/6
- No. 1738. Plastic. 18" x 7/8". Black or White. P252/400 ... each 6/-
- No. 1738C. Plastic. 18" x 7/8". Coloured. P253/404 ... each 6/6



BLUEMEL'S "AIRWEIGHT" ALLOY PUMP ...

Seamless light alloy barrel and plunger tube spring loaded at bottom. Spring loaded handle, oiled leather washer and braided rubber connection with swivelling spring collar.

- No. 1566. 15" x 7/8". P256/310 ... each 5/9
- No. 1567. 18" x 7/8". P257/408 ... each 7/-



APEX "LASTWELL" CELLULOID PUMPS

With split-steel plunger tube. Black or White.

- P258/210 12" x 7/8" ... each 4/3
- P259/300 15" x 7/8" ... each 4/6
- P260/304 15" x 7/8" Coloured ... each 5/-

C 49

W. G. CHEESE LIMITED
CYCLE AND MOTOR ACCESSORIES, WIRELESS AND ELECTRICAL SUNDRIES

JUPITER HOUSE
326-327, BRADFORD ST., BIRMINGHAM, 5
Telephone: MIDland 5804/5 (2 lines)

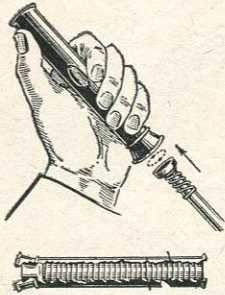

BLUEMEL'S OILED LEATHER PUMP WASHERS IN FORMING TOOL

No. 1051. $\frac{7}{8}$ " dia. packed in 2-doz. lots, in special container with forming tool incorporated.
P202/208 doz. Each 4d.
 No. 1051A. 1" dia. packed 1 doz. in a metal tube. (Forming tool not available.)
P204/306 doz. Each 6d.



DUNLOP PUMP WASHERS

No. PW/4. $\frac{7}{8}$ " Cycle and Motorcycle. Packed two dozen in tin. Oiled ready for fitting.
P207 per tin 2/-



DUNLOP COTTON RIM TAPES

$\frac{17}{32}$ " wide for Standard Narrow Section and Endrick Rims.
 No. RT/9. Superior (12 on Card).
R23/600 doz. each 9d.
 No. RT/10. Standard (Bundles of 50).
R24/Trade per bundle 17/6

DUNLOP RUBBER RIM TAPES

No. RT/5. $\frac{1}{2}$ " wide for Narrow Section and Endrick Rims.
R27/1400 doz. each 1/9
 No. RT/6. $\frac{3}{8}$ " wide for Endrick Special Lightweight Rims.
R28/1200 doz. (36 in Carton) ... each 1/6

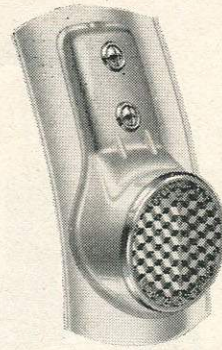

LUCAS "REALITE" REFLECTOR

No. 46. Mudguard flush fitting. White enamel.
R20/100 each 1/6

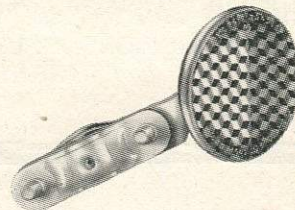

LUCAS "REALITE" REFLECTOR

No. 45S. Lightweight model, stay fitting.
R42/100 each 1/6

JUPITER RIM TAPES

Cotton: Three dozen per bundle.
R30/400 doz. each 6d.
R31/4500 gross each 6d.



"RADSPORT" REFLECTORS

Rubber mounted. 12 per Card. Silver Grey.
R18/800 each 1/3

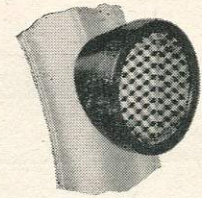

LUCAS "REALITE" REFLECTOR

No. 47. Rubber moulded body, with single nut mudguard fitting. Silver-grey.
R38/010 each 1/3



LUCAS "REALITE" REFLECTOR

No. 51. Single-nut mudguard fitting, polished light alloy body.
R39/010 each 1/3

IVORETTE CLIP-ON REFLECTORS

Supplied one dozen on Card.
R33/800 card each 1/-

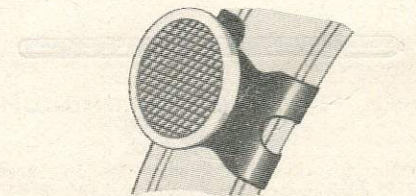

BLUEMEL'S REAR REFLECTORS

No. 61. $1\frac{1}{2}$ " face prismatic, mounted on a sliding bridge to fit on to mudguard.
R43/1200 Ref. 1493 ... per doz. 18/-
 No. 52. $1\frac{1}{2}$ " face prismatic in white case with single screw mudguard fitting. Suits guards of all widths.
R46/1400 Ref. 1492 ... per doz. 21/-
 No. 7. $1\frac{1}{2}$ " face prismatic in white case with stay clip fitting. Carded in dozens.
R47/1800. Ref. 1066/2 per doz. 27/-

REFLECTOR LENSES

$1\frac{1}{2}$ " diakon.
R49/400 doz. each 6d.

Y Y 27

W. G. CHEESE LIMITED
 CYCLE AND MOTOR ACCESSORIES, WIRELESS
 AND ELECTRICAL SUNDRIES

JUPITER HOUSE
 326-327, BRADFORD ST., BIRMINGHAM, 5
 Telephone: MIDland 5804/5 (2 lines)

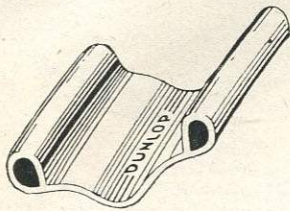

Tubular

DUNLOP STEEL RIMS

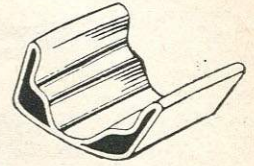

(Narrow) Section

Type and Gauge	Size (in.)	Finish					R55/Trade	Price each	
							Endrick	Wired	
Standard	22, 24, 26	Rough	Drilled	4/11	5/1
		Chromium Plated	Drilled	7/10	7/11
	27	Rough	Drilled	4/11	—
		Chromium Plated	Drilled	7/10	—
Endrick Special Lightweight	28	Rough	Drilled	5/1	5/1
		Chromium Plated	Drilled	7/11	8/-
	11, 12, 14	Rough	Drilled	4/8	4/9
	16, 18, 20†	Chromium Plated	Drilled	7/7	7/8
Tandem	26 × 1 1/4	Rough	Depressed and Pierced	5/11	—	—
	27 × 1 1/4	Chromium Plated	Depressed and Pierced	9/2	—	—
	26	Rough	Drilled	5/5	—	—
	26	Chromium Plated	Drilled	8/4	—	—
Carrier	26 × 1 1/4	Rough	Drilled	—	5/10	—
	26 × 1 1/4	Chromium Plated	Drilled	—	8/8	—
	26 × 1 1/4	Rough	Depressed and Pierced	—	8/-	10/11
	26 × 1 1/4	Chromium Plated	Depressed and Pierced	—	6/7	6/9
Heavy G Section	12 1/2 × 2 1/4	Rough	Depressed and Pierced	—	—	5/1
	20 × 2 1/2	Rough	Depressed and Pierced	—	—	5/3
	13	Chromium Plated	Drilled	—	—	5/4
	14	Chromium Plated	Drilled	—	—	—
For Moulded Cushion Tyres	15	Chromium Plated	Drilled	—	—	—
				—	—	—
Centring, Black only	Extra	—	—	2 1/2 d.
Centring and Lining, Red, Green or Bronze	Extra	—	—	3 1/2 d.
† Endrick only.									

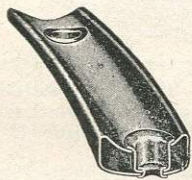

"FIAMME" ROAD SPRINT RIMS

In two weights, Road 14 ozs., or Track 12 ozs. Drilled 32/40, 36/36 or 28/28 holes. 27" only.
 R59/3302 pair ... per pair 49/11
 R60/3000 pair ... 12 pairs rate

WESTRICK RIMS

R62/904 ... per pair 14/-

STANDARD RIM WASHERS

R63/Trade ... per gross 5d.

WEINMAN ALLOY RIMS

Alesa High Pressure. 26" or 27" × 1 1/4".
 R66/2609 ... per pair 40/-

WEINMAN ALLOY ENDRICK RIMS

26" × 1 1/4".
 R67/3000 ... per pair 45/-

SCHERENS HOLLOW SPRINT RIMS

R68/-/ ... per pair -/-

SCHERENS WOOD INSERT SPRINT RIMS

R69/-/ ... per pair -/-

SPOKES AND NIPPLES

Rustless. All lengths. Packed 1 gross.

Per gross

R72/706 15 gauge ... Trade

R73/804 14 gauge ... Trade

R74/1102 15/17 gauge ... Trade

R75/1307 13 gauge ... Trade

R76/1502 12 gauge ... Trade

R77/1500 12/14 gauge ... Trade

5d. per gross extra if boxed.

Y S 7

W. G. CHEESE LIMITED
 CYCLE AND MOTOR ACCESSORIES, WIRELESS
 AND ELECTRICAL SUNDRIES

JUPITER HOUSE
 326-327, BRADFORD ST., BIRMINGHAM, 5
 Telephone: MIDland 5804/5 (2 lines)

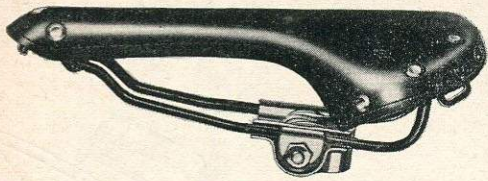

BROOKS CHAMPION SPORTS SADDLE
No. B17. Swallow. Two-wire. Size 11" x 6" x 3 1/8". Weight 1 lb. 9 ozs.
S5/4500 Chrome finish ... each 67/6



BROOKS CHAMPION SPORTS SADDLE
No. B17. Competition. Two-wire Sports. Size 11" x 6 1/2" x 3 1/8". Weight 1 lb. 7 ozs.
S6/3008 Black enamel ... each 46/-
S7/3204 Chrome finish ... each 48/6



BROOKS CHAMPION SPORTS SADDLES
No. B17. Standard. Two-wire. Size 11" x 6 3/4" x 3 1/8". Weight 1 lb. 12 ozs.
S10/3000 Black enamel ... each 45/-
S11/3108 Chrome finish ... each 47/6
No. B17. Flyer. Two-wire. Size 11" x 5 1/4" x 3". Weight 1 lb. 10 ozs.
S9/3108 Chrome finish ... each 47/6

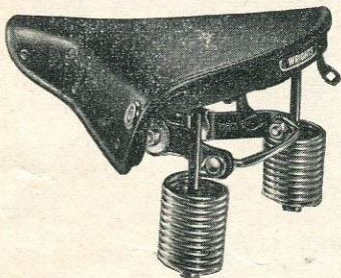

WRIGHTS POWER-CYCLE SADDLE
No. S65/3. For Motorised Bicycles. Sprung mattress interior with thick felt underlay. Vynide waterproof seat, size, 10 3/4" x 11 1/2". Shock absorbing tension coils, double girder pivoted frame and chromium-plated rear coils and clip. Enamelled.
S26/1804 ... each 27/6

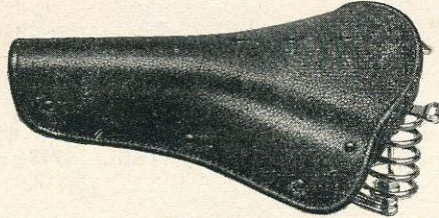

BROOKS MATTRESS SADDLE
No. B22. Multi-mattress spring construction. Four-wire bracket, with two rear coils. Size: 10 3/4" x 9 1/4" x 3 1/8". Chrome plated.
S14/1804 ... each 27/6

BROOKS HEAVY DUTY SADDLES
No. B90/2. Loop-front. Size 11" x 9 1/4" x 4 1/8". Weight, 3 lbs. 12 ozs.
S15/3804 Black enamel ... each 57/6
S17/4104 Chrome finish ... each 62/-
No. B90/3. Loop-front. Size 12" x 9 3/4" x 4 1/8". Weight 4 lbs. 4 ozs.
S18/4200 Black enamel ... each 63/-
S19/4500 Chrome finish ... each 67/6

BROOKS STANDARD SWALLOW SADDLE
No. CL3. Bristol. Standard enamel.
S22/1009 ... each 16/-

BROOKS SWALLOW RACING SADDLE
No. CL3.
S23/1206 ... each 18/9

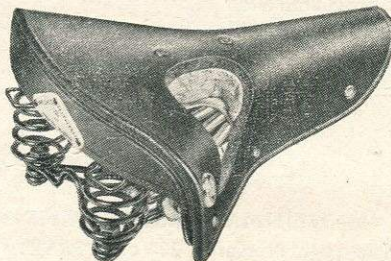

WRIGHTS FEATHERBED SADDLE
No. 505. A sprung mattress saddle with felt underlay, airfoam interior and soft leather anti-friction lining. Vynide waterproof seat corner-guard protected. Ladies' and Gent's Models. Enamelled.
S25/1804 ... each 27/6

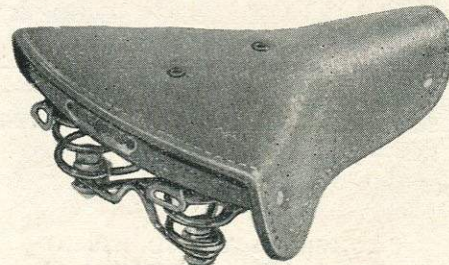

"RADSPORT" MATTRESS SADDLE
 Tan with chrome undercarriage.
S13/1000 ... each 15/-



BROOKS CHAMPION SPORTS SADDLES
No. B15. Narrow. Two-wire. Size 11" x 6" x 3 1/8". Weight 1 lb. 10 ozs.
S28/2108 Black enamel ... each 32/6
S29/2304 Chrome finish ... each 35/-
No. B15. Flyer. Two-wire. Size 11" x 5 1/4" x 3". Weight, 1 lb. 11 ozs.
S27/2304 Chrome finish ... each 35/-

BROOKS TOURIST SADDLES
No. B73. Three-coil. Size: 10 1/4" x 8 1/4" x 3 7/8". Weight, 2 lbs. 9 ozs. Gent's Model.
No. B73/L. Ladies' Model.
S32/2304 Black enamel ... each 35/-
S33/2504 Chrome finish ... each 38/-



BROOKS JUVENILE SADDLE
No. J5. Four-wire. Size 10 1/4" x 6 3/4" x 2". Weight, 1 lb. 8 ozs.
S35/1400 Black enamel ... each 21/-



WRIGHTS "OLYMPIAN 56" SPORTS SADDLE
No. 56L. Leather seat which floats on supporting mattress springs. Size: 11" x 6". Weight, 1 lb. 15 ozs.
S37/1711 ... each 26/10

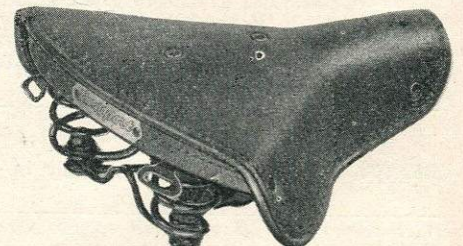

"RADSPORT" MATTRESS SADDLE
 Black.
S39/900 ... each 13/6

A 11 14

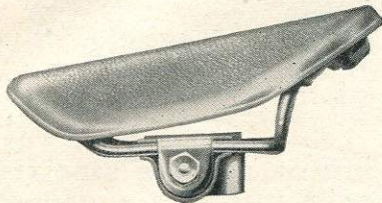

LYCETT'S JUVENILE RUBBER SADDLE
Model L4. Large seating area. Rubber envelope top on strong wire frame. Size: $7\frac{3}{8}'' \times 7'' \times 3''$.
S50/600 each 9/-

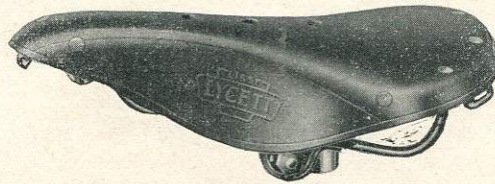

LYCETT'S STANDARD SADDLE
No. L15. Two-wire. Sports Model with solid leather top. Black enamel. Size: $11'' \times 6\frac{3}{4}'' \times 3\frac{1}{8}''$.
S61/1600 Enamel each 24/-
S62/1708 Chromium each 26/6

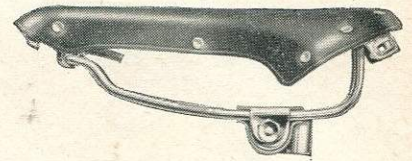

LYCETT'S SWALLOW SADDLE
Model L15. Cut-away top. Patent bridge support. Chromium plated. Size: $11'' \times 6'' \times 3\frac{1}{8}''$.
S75/1608 each 25/-

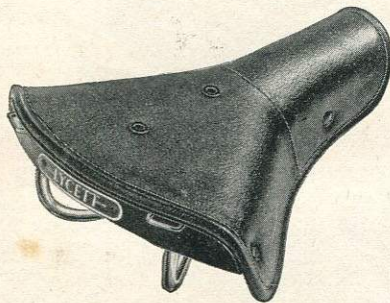

LYCETT'S JUVENILE MATTRESS
No. S5. Mattress spring construction on two-wire frame. Tailored felt and top covered leathercloth. Black enamel finish. Size: $8\frac{3}{4}'' \times 6\frac{1}{2}'' \times 3''$.
S52/904 each 14/-

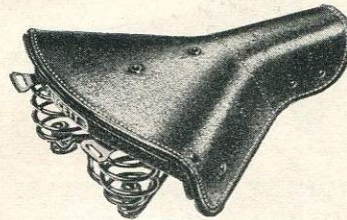

LYCETT'S MATTRESS SADDLE
No. S21. Suitable for ladies or gents. Multi-spring mattress, girder frame. Four-wire bracket with two rear coils. Leathercloth covering tailored felt. Black enamel finish. Size: $9\frac{3}{4}'' \times 8\frac{1}{2}'' \times 2\frac{3}{8}''$.
S65/1104 Enamel each 17/-
S66/1304 Chrome each 20/-

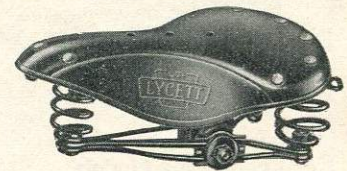

LYCETT'S TOURIST SADDLE
No. L71. Three-coil. Size: $10'' \times 8\frac{1}{4}'' \times 3\frac{7}{8}''$. Weight, 2 lb. 2 oz. Gent's Model.
S77/1400 Enamel each 21/-
No. L71L. Ladies' Model. Size: $9\frac{3}{4}'' \times 8\frac{1}{4}'' \times 3\frac{7}{8}''$.
S78/1400 Enamel each 21/-



LYCETT'S NARROW SADDLE
L15. Narrow. Size: $11'' \times 6'' \times 2\frac{7}{8}''$. Weight, 1 lb. 7 oz.
S54/1600 Enamel each 24/-
S55/1708 Chromium each 26/6



MANSFIELD RACING SADDLE
No. 38N. Specially built for speed work. Size: $11\frac{1}{2}'' \times 6''$. Weight, 1 lb. 8 oz.
S68/1108 each 17/6

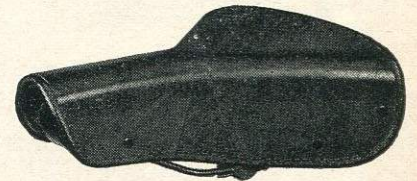

LYCETT'S SADDLE
Model L50.
S79/1000 each 15/-

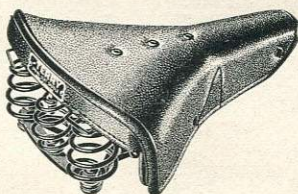

TERRY'S EXTRA COIL SADDLES
 With patent suspension. Automatically adjusts to carry any weight rider.
No. 1087X. Ladies' Model. Size: $9\frac{1}{2}'' \times 8\frac{1}{2}''$.
S57/1608 each 25/-
No. 1086X. Gent's Model. Size: $9\frac{1}{2}'' \times 10\frac{1}{2}''$.
S58/1608 each 25/-
Replacement Top
S59/808 each 13/-



MANSFIELD CLUB SADDLE
 Butt leather top supported by mattress coil springs. Size: $11\frac{1}{2}'' \times 5\frac{1}{2}''$. Weight, 1 lb. 13 oz.
S69/1700 each 25/6



MANSFIELD "ORMOND" SADDLE
 Sprint saddle of special leather on rustproof Duralumin frame. Size: $11\frac{1}{2}'' \times 4\frac{1}{2}''$. Weight, 15 oz. approx.
S70/2304 each 35/-

MANSFIELD "BATH ROAD" RACING SADDLE
 Fitted with a wire frame, a beautifully balanced Racing Saddle at an attractive price. Size: $11\frac{1}{2}'' \times 5\frac{1}{2}''$. Weight 1 lb. 7 oz.
S80/2000 each 30/-

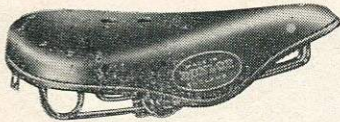

**DUNLOP SADDLES
4-Wire Models**

No. D6. Size 10" x 8".
S104/1108 ... each 17/6

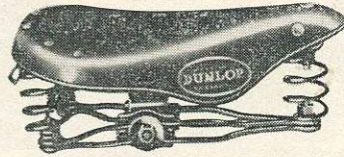

**DUNLOP SADDLES
3-Coil Models**

No. D7. Size 10" x 8". 4-wire bracket, three spiral springs.
S112/1204 ... each 18/6



DUNLOP JUVENILE SADDLES

No. S.1. 8" x 6 1/4". 2-wire, 9/16"/5/8" eyebolt. S126/604 ... each 9/6
No. S1. 8" x 6 1/4". 2-wire, 7/16"/1/2" eyebolt. S128/608 ... each 10/-

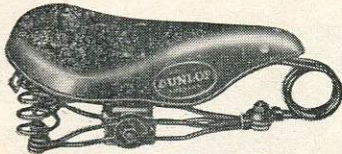

**DUNLOP SADDLES
Loop Front Models**

No. D8. Size 10" x 8". 4-wire bracket, loop front, spiral rear springs.
S105/1204 ... each 18/6

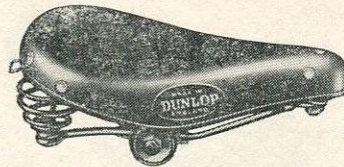

DUNLOP LADIES' SADDLES

No. PT13. Size 9 3/4" x 8". Two-coil. S114/1300 ... each 19/6
No. PT15. Size 9 3/4" x 8". Three-coil. S115/1208 ... each 19/-

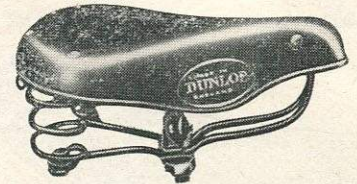

DUNLOP JUVENILE SADDLES

No. S3. 2-coil. Each
S131/700 8" x 6 1/4" ... 9/16"/5/8" eyebolt 10/6
S132/700 8" x 6 1/4" ... 7/16"/1/2" eyebolt 10/6
S133/704 8" x 6 1/4" ... 5/8" or 7/8" clip 11/-

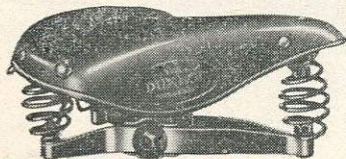

DUNLOP CARRIER SADDLES

No. F26. Size 10 3/4" x 8 3/4". Girder bracket, three-coil springs.
S106/1404 ... each 21/6

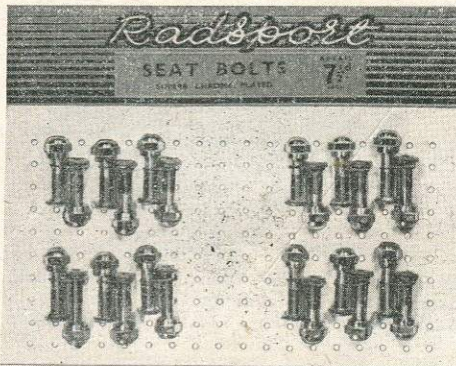

"RADSPORT" SEAT BOLTS

Superb design. 24 per Card.
S118/1000 card ... each 7 1/2 d.

JUVENILE SADDLE EYE BOLTS

S120/103 ... each 1/11

CAMPAGNOLO SEAT PILLARS

Patented, with chrome clips. Sizes 3, 4 and 5.
S122/2601 ... each 36/-

ALLOY SEAT PILLARS

S124/206 8" ... each 3/9

BAYCLIFF SADDLE COVERS

No. CL97. In Khaki, single texture material.
S136/206 ... each 3/9

CANEX SADDLE COVERS

No. 39R. Velvet corduroy top, reversible, inside showerproof, rubber sponge padding.
S138/304 ... each 5/-

CRESTA FLUTED SEAT PILLAR

Best quality. 9" x 1 1/2". Chrome plated.
S139/209 ... each 4/2

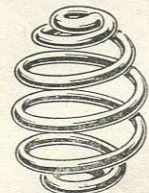

TERRY'S No. 62 SADDLE SPRINGS

Enamelled.
S141/208 ... 3-coil ... per doz. 4/-
S142/300 ... 4-coil ... per doz. 4/6
S143/304 ... 5-coil ... per doz. 5/-



TERRY'S No. 524 SADDLE SPRINGS

Enamelled.
S109/508 3-coil ... per doz. 8/6
S110/800 4-coil ... per doz. 12/-
S111/1300 5-coil ... per doz. 19/6

W. G. CHEESE LIMITED
CYCLE AND MOTOR ACCESSORIES, WIRELESS
AND ELECTRICAL SUNDRIES

JUPITER HOUSE
326-327, BRADFORD ST., BIRMINGHAM, 5
Telephone: MIDland 5804/5 (2 lines)



ASHBY "BLOCK" SPANNERS
 No. 2. Heavy duty drop-forged and hardened. Standard cycle 4-nut fitting.
 S222/110 each 2/8



ASHBY "PEG & CONE" SPANNERS
 No. 9. Heavy duty pattern. Separate hardened pegs and spanner body. 12-gauge.
 S276/608 each 10d.

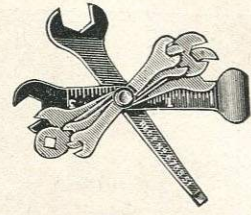

LINCO SPANNER SET
 No. 4C. Nickel-plated finish.
 S246/200 each 3/-

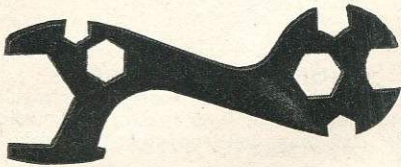

PHILLIPS "EIGHT-IN-ONE" SPANNERS
 No. M714. 12 on a Card.
 S226/Trade per card 11/3

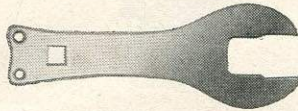

BROOKS PEG AND CONE SPANNER
 S238/008 No. 3 each 1/-



LINCO SPANNER SET
 No. 6E. Suitable for motor cyclists.
 S248/208 each 4/-

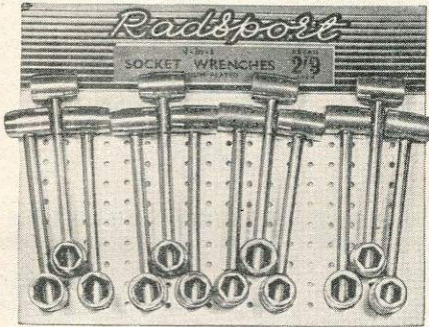

"RADSPORT" 4-IN-1 SOCKET WRENCHES
 Chromium plated. 12 per Card.
 S229/2200 card each 2/9



BROOKS TENSION SPANNER
 S239/010 No. 3/T each 1/3

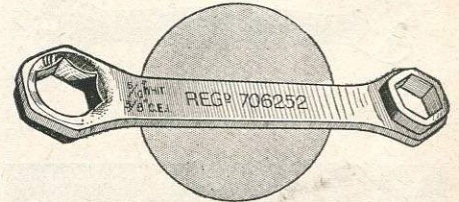

LINCO BOX TYPE SPANNERS
 No. 75D. Size, $\frac{5}{16}$ " \times $\frac{3}{8}$ ".
 S250/706 doz. each 11d.

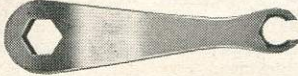

BROOKS TENSION SPANNER
 S240/108 No. 5 each 2/6



BROOKS SIX-WAY SPANNER
 S242/010 No. 7 each 1/3

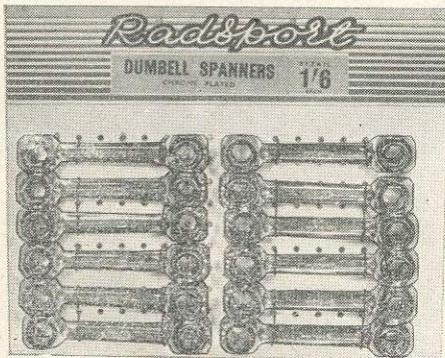

"RADSPORT" DUMBBELL SPANNERS
 12 per Card.
 S230/1200 card each 1/6



BROOKS FOUR HOLE SPANNER
 S243/008 No. 8 each 1/-

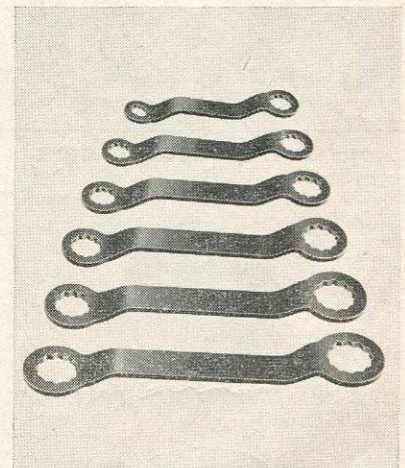

LINCO No. 8 RING SPANNER SET
 Set of six Whitworth ring spanners. Sizes:
 $\frac{1}{8}$ " \times $\frac{3}{16}$ ", $\frac{3}{16}$ " \times $\frac{1}{4}$ ", $\frac{1}{4}$ " \times $\frac{5}{16}$ ", $\frac{5}{16}$ " \times $\frac{3}{8}$ ", $\frac{3}{8}$ " \times $\frac{7}{16}$ ",
 $\frac{7}{16}$ " \times $\frac{1}{2}$ ".
 S252/500 per set 7/6



BROOKS HEAD AND LOCK RING SPANNER
 S244/010 No. 6 each 1/3

FOR MOTOR CYCLE SPANNERS SEE PAGE 108

B 275

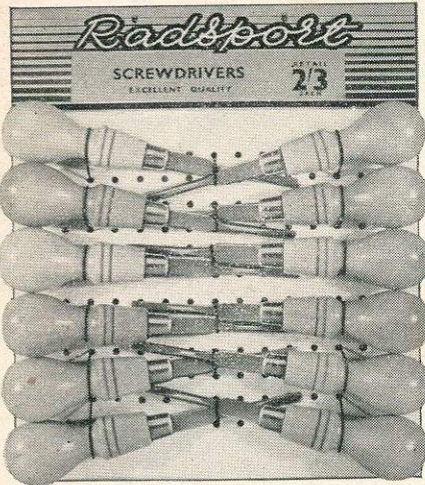

RADSPORT WOODEN HANDLED SCREWDRIVERS
12 per Card.
S291/1800 card each 2/3



TERRY'S CYCLE PEDAL SPANNERS
No. 648A. 12".
S298/208 each 4/-

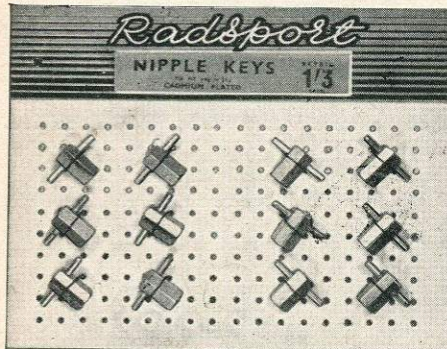

"RADSPORT" NIPPLE KEYS
12 per Card.
S300/900 each 1/3

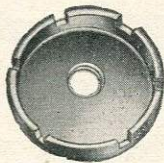

BROOKS SIX-WAY NIPPLE KEY
S335/008 No. 3 each 1/-



CYCLO UNIVERSAL NIPPLE KEYS
No. 135. Supplied carded.
S337/104 each 2/-

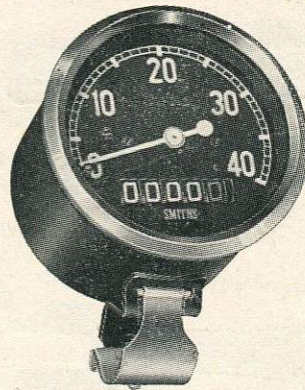

SMITHS CYCLE SPEEDOMETERS
Popular Model. Supplied with flexible drive, gear ring and pinion set. Gives accurate readings from 0-40 m.p.h., as well as recording distances in 1/10ths of a mile up to 9,999.
S304/3508 complete 47/6

Spare Parts
S305/2801½ Head only each 37/6
Flexible Drive complete up to 30".
S306/406 each 6/-
Flex: Inner Drive or Outer Casing only, up to 30".
S307/203 each 3/-
S308/710½ Gear Drive each 10/6
Fibre Pinion only.
S309/300 each 4/-
S310/309 Gear Ring each 5/-

De-Luxe Model. Designed for use on motor assisted bicycles.
Gives steady readings from 0-40 m.p.h., and records distance in 1/10ths of a mile up to 9,999. Polychromatic grey finish with chromium bezel and black dial with white figures and red pointer.
S312/4103 complete 55/-

Spare Parts
S313/3000 Head only each 40/-
S314/406 Gear Rings each 6/-
S315/706 Gear Drive each 10/-
S316/605 Flex, up to 30" each 8/6

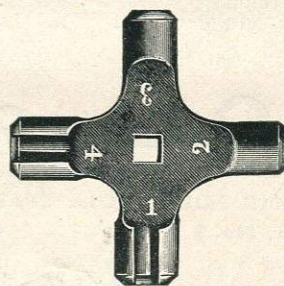

ALBION NIPPLE KEYS
No. 1383. Supplied 12 on a card.
S318/Trade per card 4/4



TERRY'S SPOKE NIPPLE SPANNER
No. 1160. Hardened and Tempered Steel.
S319/1000 doz. each 1/3

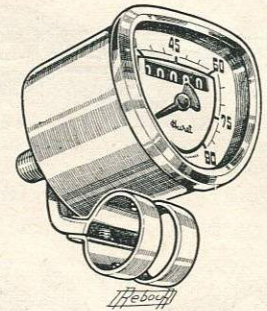

"HURET" SPEEDOMETERS
Complete set, in a carton containing triangular speedometer head, 0-40 m.p.h., transmission cable, 26" long, left and right-hand driving gear.
No. MT23. For 23" wheels.
S322/2700 each 36/-
No. MT24. As above but for 24" wheels.
S323/2700 each 36/-
No. MT26. As above but for 26" wheels.
S324/2700 each 36/-
No. MT27. As above but for 27" wheels.
S325/2700 each 36/-

SPEEDO FOR MOPED see page 107



"HURET" SPEEDOMETER SPARES
Driving gears for the following wheel sizes, 23", 24", 26", 27" and 28".
S328/905 each 12/6
Special driving gears with replacement nuts for Raleigh moped.
S329/1103 each 15/-
Standard complete transmission cable, 26".
S330/508 each 7/6
Alternative lengths as required from 20" to 31".
S331/508 each 7/6
Flexible cables (inner).
S332/305 each 4/6
Sheath for transmission cables (outer).
S333/203 each 3/-



RADSPORT ADJUSTABLE SPANNERS
6 per Card.
S295/1908 each 4/11

E 147

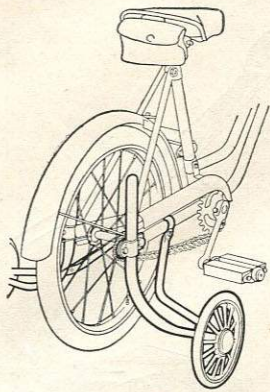

SHURESTA STABILIZER

Adjustable for 14", 16", 18" and 20" cycle wheels. Give child a sense of balance.

S340/1206 each 18/9

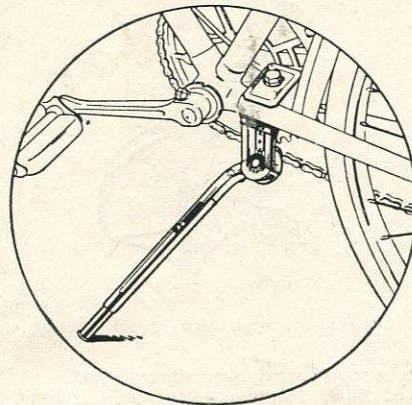

SHURESTA XPT ADJUSTABLE STAND

Lightweight stand, fully adjustable up to 28" wheels. Finished polished aluminium and plated steel.

S346/500 each 7/6

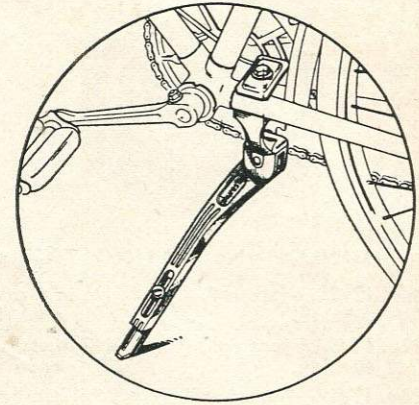

SHURESTA ADJUSTABLE PROP CYCLE STAND

Fits all makes of cycles and is adjustable for 26" or 28" wheels. Finished polished aluminium.

S352/510 each 8/9

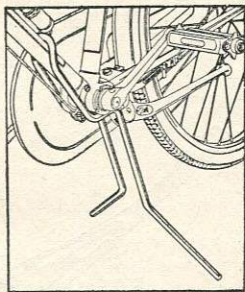

RALEIGH "VINCE" CYCLE STANDS

Very strongly made.

S342/509 each 8/6

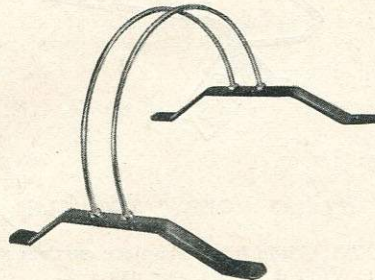

PHILLIPS CYCLE STANDS

No. 467. The ideal stand for window displays, showrooms, club premises, in the house and anywhere where cycles are left unattended. Quickly and easily adjustable for wheel and tyre sizes. Light construction, perfectly rigid and easily portable. Protects the bicycle from wall rubbing, scratching or over-balancing.

S347/508 each 8/6

"LAPIZE" TOE STRAPS

S343/310 per pair 5/9

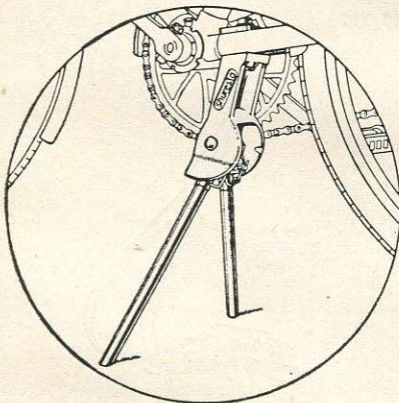

SHURESTA XL CYCLE STAND

Fits all makes of cycles. Suitable for motorised cycles. The unique folding action retracts the legs neatly along the chain stays. Finished polished aluminium and plated steel.

S356/1004 each 15/6

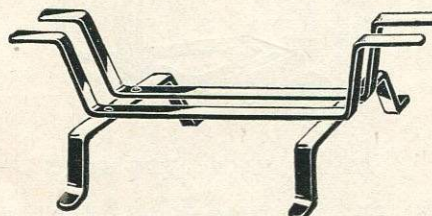

ASHBY "EMPIRE" CYCLE STAND

No. 4. Easily adjusted to suit all rim sizes. Packs flat, 21" x 4" x 1½". Enamelled black.

S350/400 each 6/-

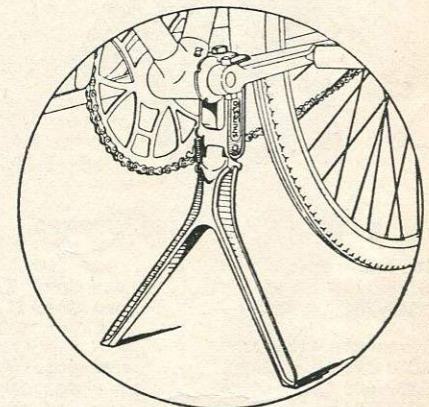

SHURESTA "V" CYCLE STAND

Fits all makes of cycles from 26" to 28" wheels. Suitable for motorised cycles. Finished polished aluminium.

S353/706 each 11/3

A 8 15

W. G. CHEESE LIMITED
CYCLE AND MOTOR ACCESSORIES, WIRELESS
AND ELECTRICAL SUNDRIES

JUPITER HOUSE
326-327, BRADFORD ST., BIRMINGHAM, 5
Telephone: MIDland 5804/5 (2 lines)



DUNLOP INSULATING TAPE

No. IT/2. 2-yard roll, $\frac{5}{8}$ " wide (24 in carton).
 T16/400 doz. each 6d.
 No. IT/5. 5-yard roll, $\frac{5}{8}$ " wide (12 in carton).
 T17/600 doz. each 9d.
 No. IT/10. 10-yard roll, $\frac{5}{8}$ " wide (12 in box)
 T18/1000 doz. each 1/3
 No. IT/25. 25-yard roll, $\frac{1}{2}$ " wide.
 T19/1600 doz. each 2/-

INSULATING TAPE

Excellent Quality

Five-yard roll $\times \frac{1}{2}$ " width.
 T88/400 doz. each 6d.
 10-yard roll $\times \frac{5}{8}$ " wide.
 T89/800 doz. each 1/-

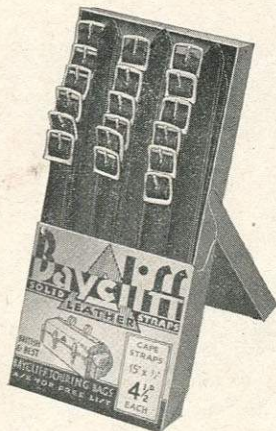

BAYCLIFF LEATHER STRAPS

Blue Chrome
 S386/500 ... 9" $\times \frac{5}{8}$ " ... per doz. 7/6
 S387/704 ... 18" $\times \frac{7}{8}$ " ... per doz. 11/-

Natural Leather
 S388/408 ... 7" $\times \frac{1}{2}$ " ... per doz. 7/-
 S389/608 ... 15" $\times \frac{1}{2}$ " ... per doz. 10/-
 S390/704 ... 18" $\times \frac{1}{2}$ " ... per doz. 11/-

Black Leather
 S392/304 ... 7" $\times \frac{1}{2}$ " ... per doz. 5/-
 S394/504 ... 15" $\times \frac{1}{2}$ " ... per doz. 8/-
 S395/600 ... 18" $\times \frac{1}{2}$ " ... per doz. 9/-
 S396/1008 ... 24" $\times \frac{1}{2}$ " ... per doz. 16/-
 S397/1208 ... 30" $\times \frac{1}{2}$ " ... per doz. 19/-
 S398/1408 ... 36" $\times \frac{1}{2}$ " ... per doz. 22/-
 S399/1600 ... 42" $\times \frac{1}{2}$ " ... per doz. 24/-



"CHRISTOPHE" TOE CLIPS

Light spring steel, chromium plated.
 No. 50C, Medium. No. 50SC, Long.
 No. 50DAC, Short. No. 51, Clip on.
 T5/404 per pair 6/6

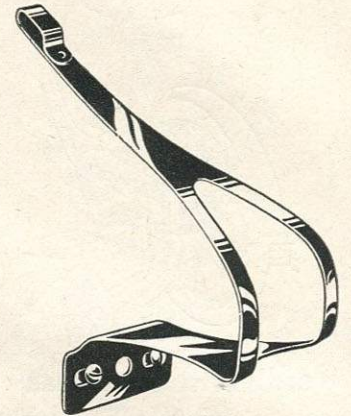

ASHBY "TYPE MONIQUE" TOE CLIPS

No. 17LC. With squarish entry for the rider's shoe. Fixed type for rat-trap pedals. Made from carbon steel, hardened and tempered. Weight, $3\frac{1}{4}$ ozs. per pair. Chromium plated.
 T8/304 per pair 5/-

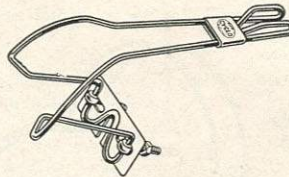

CYCLO "OPPY" TOE CLIP

Ref. 751. Made from one-piece rustless piano wire. Weight $2\frac{1}{2}$ ozs. per pair.
 T6/202 each 3/2

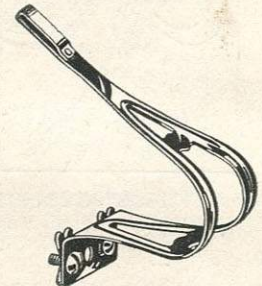

ASHBY "PRINCIP" TOE CLIPS

No. 12LC. For rat-trap pedals. Made from carbon steel. Weight, 3 ozs. per pair. Chromium plated.
 T10/211 per pair 4/4

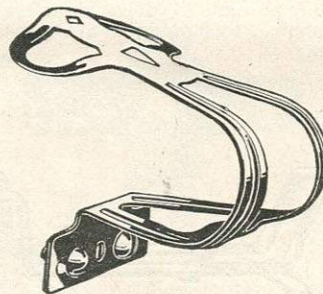

ASHBY "ACE" TOE CLIPS

No. 20LC. For rat-trap pedals. Spread head pattern to take toe strap. Made from carbon steel. Weight under $2\frac{1}{2}$ ozs. per pair. Chromium plated.
 T7/206 per pair 3/8

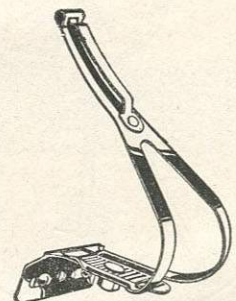

ASHBY "WANDERLUST" TOE CLIPS

No. 15LC. For rat-trap pedals. Fully adjustable clip and long strap loop. Made from carbon steel. Weight, 4 ozs. per pair. Chromium plated.
 T12/304 per pair 5/-

Y H 12

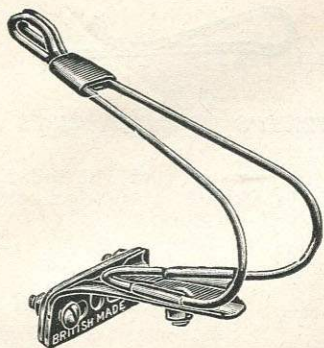

SMITHS TOE CLIPS

No. 8. Adjustable tempered steel wire. Chromium plated.
T31/204 per pair 3/6

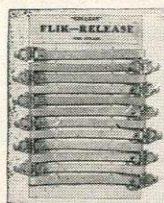

FLIK TOE STRAPS

Carded 12 pairs, assorted, all red or all blue.
T43/204 per pair 3/6

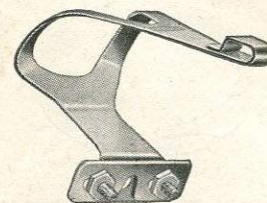

BROOKS TOE CLIPS

No. 1. Best quality spring steel, chromed. Three sizes: Small, medium and large.
T42/310 per pair 5/9

"LAPIZE" TOE STRAPS

T47/310 per pair 5/9



BROOKS TOE CLIP STRAPS

No. 1R. Chrome leather. Fitted with special quick-release buckle. Red.
T44/300 per pair 4/6

No. 1. Chrome leather. Fitted with special quick-release buckle.
T48/206 per pair 3/9

No. 2. Chrome leather. With spring-loaded buckle.
T45/108 per pair 2/6

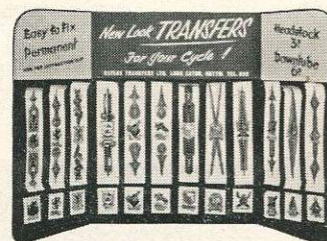

KAYLEE TRANSFERS

Showcard contains 12 designs of transfers to head stocks and down tubes. (12 of each design).
T49/Trade Price per card 72/-

CYCLE TRANSFERS

Miscellaneous:

- | | |
|---------------------|-----------------------|
| CS/Speedster | CS/Continental |
| CS/Sports | CS/Checkers |
| CS/Atomic Flier | (all colours) |
| CS/Coronation Model | CS/Meteor A |
| CS/Light Roadster | CS/Red Devil A |
| CS/Safety Model | CS/Black Panther |
| CS/Club Model | CS/Chevron A (pair) |
| CS/Grand Prix A | CS/Chevron B (pair) |
| CS/Tour de France | CS/Pennant (set of 4) |
| T52/Trade | per doz. 4/- |

Headstock Transfers:

- | | |
|------------------|-----------------|
| CS/Lion | CS/Eagle |
| CS/Regal | CS/Rocket |
| CS/Empire | CS/Pegasus |
| CS/Chieftain | CS/Grand Prix B |
| CS/Invader | CS/Senior T.T. |
| CS/Centurion | CS/Meteor B |
| CS/Revenge | CS/Red Devil B |
| CS/Clipper | CS/Glory |
| T53/Trade | per doz. 2/- |

Union Jack Transfers

- | | |
|------------------------|---------------|
| T54/Trade CS/UJ Large | per doz. 1/8 |
| T55/Trade CS/UJ Medium | per doz. 10d. |
| T56/Trade CS/UJ Small | per doz. 6d. |

Letter and Numeral Transfers

- AL/6. All Colours.
T58/Trade per doz. 4/-

T 25a

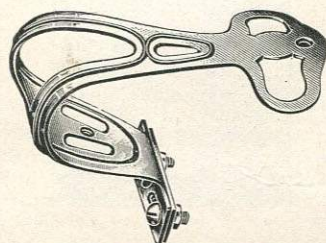

SMITHS TOE CLIPS

No. 17. Made in spring steel, with ribbed and looped clip to take straps.
T34/200 per pair 3/-

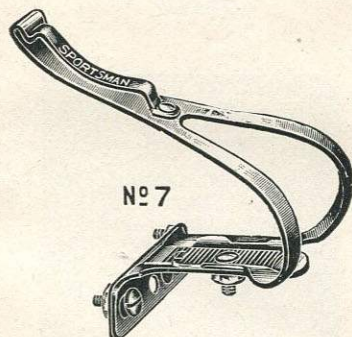

SMITH'S TOE CLIPS

No. 7. Tempered spring steel, light and strong. Chromium plated.
T35/302 per pair 4/9

SHOCKSTOP RUBBER SHOE PLATES

T36/104 per pair 2/-

PETERS SHOE PLATES

T37/2000 doz. prs. per pair 2/6

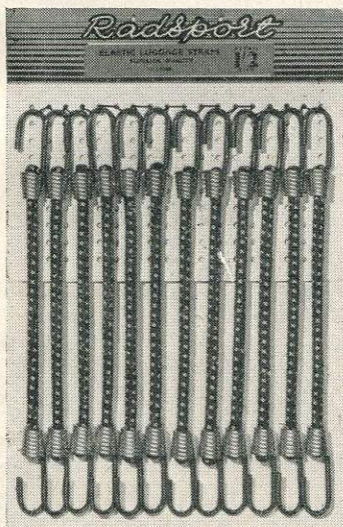

"RADSPORT" ELASTIC STRAPS

T62/904 card 12" each 1/2
T63/1304 card 18" each 1/8



TERRY'S TROUSER BANDS

No. 4. Popular Medium Bands.
 T72/400 Bronzed ... per doz. pairs 6/-
 T73/600 Chromium ... per doz. pairs 9/-

TERRY'S TROUSER BANDS

No. 1123. Celluloid Covered Bands.
 T75/800 ... per doz. pairs 12/-

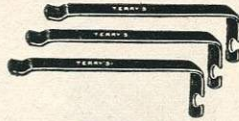

TERRY'S "ONE-MINUTE" TYRE LEVERS

No. 735. Spring steel tyre levers. All edges rounded and smooth. Blued steel finish. Packed in sets of three. Carded.
 T85/010 ... per set 1/3

TERRY'S SPOON TYRE LEVERS

No. 71. Hardened and tempered steel cycle tyre lever. Bronzed and carded.
 T82/600 ... per doz. 9/-



TERRY'S TROUSER CLIPS

No. 2. Narrow steel clips with rolled ends.
 T87/300 Bronzed ... per doz. pairs 4/6

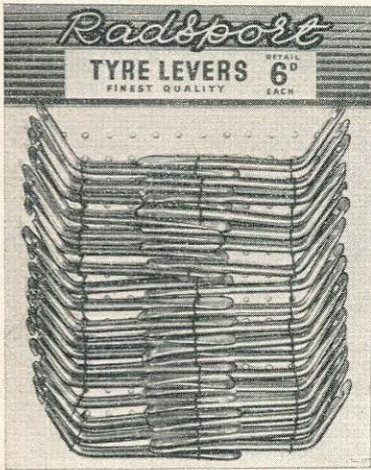

"RADSPORT" TYRE LEVERS

Finest quality. 36 per card.
 T79/1009 card ... each 6d.

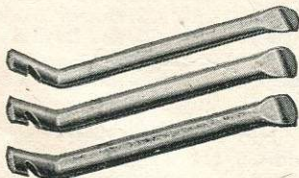

BROOKS TYRE LEVERS

No. 6. In sets of three.
 T80/104 ... per set 2/-

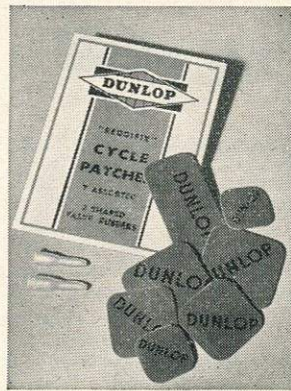

DUNLOP "REDDIFIX" CYCLE PATCHES

No. RP/7. Packet of 7 assorted, including 2 shaped valve rubbers (24 packets on card).
 T96/304 doz. ... each 5d.



DUNLOP "REDDIFIX" CYCLE PATCH STRIP

No. RPS/2. Rolls 9" x 3". 12 on card.
 T92/1000 doz. ... per roll 1/3
 No. RPS/3. Rolls, 36" x 3".
 T93/Trade ... per doz. 30/-

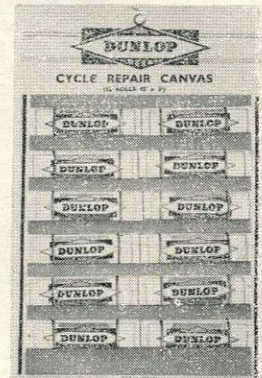

DUNLOP CASING REPAIR MATERIAL

No. CF/3. Canvas 12" x 3" (12 on card).
 T95/600 doz. ... each 9d.

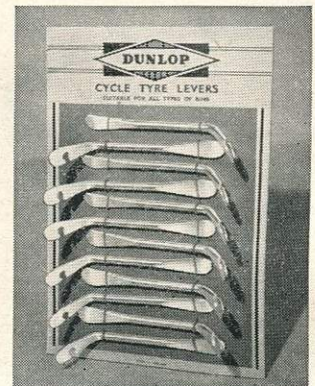

DUNLOP CYCLE TYRE LEVERS

Type TL/7. Cranked. 12 on card.
 T86/400 ... per doz. 6/-

A 3 27



JOHN BULL "OBLONG" REPAIR OUTFIT

Contents: Strip of "Gang" Patches, French chalk, rubber solution, valve cleaning tool, glasspaper, pump connection washers, valve tubing, prepared canvas rolls, marking crayon. Packed 2 dozen in carton.

T100/1400 doz. ... each 1/9



JOHN BULL "JUNIOR" REPAIR OUTFIT

Contents: Strip of "Gang" patches, rubber solution, prepared canvas, glasspaper, French chalk in block form, valve tubing. Boxed in 2 dozens.

T101/1000 doz. ... each 1/3



JOHN BULL RUBBER SOLUTION

Non-inflammable. Packed in 2 dozens.
T102/400 doz. Small Tubes ... each 6d.
T103/504 doz. Large Tubes ... each 8d.

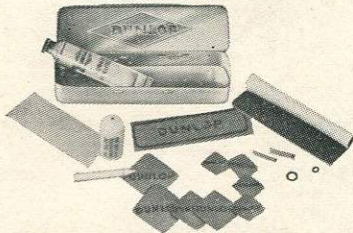

DUNLOP "LONG" REPAIR OUTFIT

No. RO/7. Contains: Patches, solution dusting chalk puffer, canvas, sulphur remover, straight valve rubber, crayon and pump connection washers. Packed 12 in carton.

T107/1200 doz. ... each 1/6



DUNLOP "MIDGET" REPAIR OUTFIT

No. RO/9. Contains: Patches, solution, sulphur remover, straight valve rubber and canvas. Packed 12 in carton.

T113/904 doz. ... each 1/2

DUNLOP "EASY-PUMP" VALVES

CV/30. Easily replaces rubber sleeved plug. Complete with dust caps. Supplied 12 pairs on display card.

T119/800 card ... per pair 1/-



DUNLOP VALVE TUBING

No. VT/3. 12 yards in tin.
T120/Trade ... per tin 7/6

No. VT/4. 1 lb. reel (approx. 90 yards).
T122/Trade ... per reel 40/-



DUNLOP RIM CEMENT

No. RC/1. For fixing tubular tyres to wood or alloy rims. Does not set hard. A brush is included in the top of the flask.

T110/2800 doz. Flask (approx. 4 ozs.) each 3/6



DUNLOP SHAPED VALVE RUBBERS

Designed to the shape of the valve plug, and made from the highest grade latex.

No. VT/2. Packet of 5 pieces (36 packets on card).

T114/600 card ... each 3d.

No. VT/5. Tin (500 approx.)
T115/Trade ... per tin 5/-



DUNLOP DUSTING CHALK

No. FC/2. Small flask.
T111/008 ... each 1/-

No. FC/3. 12 oz. tin (approx.)
T112/106 ... each 2/3

JOHN BULL VALVE TUBING

T117/600 (36 packets per card) each 3d.



ROMAC "CURE-C-CURE" CYCLE REPAIR OUTFIT

No. CC48. With tube solution and extra contents.

T125/1200 ... each 1/6

ROMAC "CURE-C-CURE" CYCLE PATCHES

No. CC54. Assorted sizes.
T126/1600 ... per packet, each 8d.

D 246

W. G. CHEESE LIMITED
CYCLE AND MOTOR ACCESSORIES, WIRELESS
AND ELECTRICAL SUNDRIES

JUPITER HOUSE
326-327, BRADFORD ST., BIRMINGHAM, 5
Telephone: MIDland 5804/5 (2 lines)

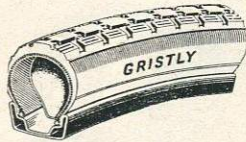

JOHN BULL GRISTLY

A luxury tyre, made of pure gristly rubber for years of trouble-free service. Sizes: $26 \times 1\frac{1}{2}$, $1\frac{3}{8}$; $28 \times 1\frac{1}{2}$.

T300/1505 each 22/-

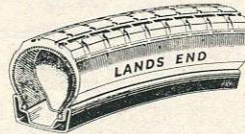

JOHN BULL LAND'S END

A sturdily built general purpose tyre of new design to give maximum value at lowest cost. Sizes: $26 \times 1\frac{1}{4}$, $1\frac{3}{8}$, $1\frac{1}{2}$; $28 \times 1\frac{1}{2}$.

T306/901 each 12/11

T307/406 Inner Tube each 6/5



JOHN BULL SAFETY SPEED

With the famous ratchet tread for extra driving effort and skid-free braking. Sizes $26 \times 1\frac{1}{4}$, $1\frac{3}{8}$; $27 \times 1\frac{1}{4}$.

T314/1200 each 17/2

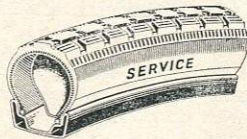

JOHN BULL NEW SERVICE

The famous "Lapland" tyre, made of toughened pure rubber for speed, lightness and strength. Sizes: $26 \times 1\frac{1}{4}$, $1\frac{3}{8}$, $1\frac{1}{2}$.

T302/1305 each 19/2

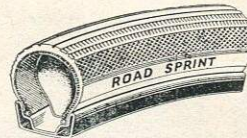

JOHN BULL ROAD SPRINT

Extremely light, fast and safe, combining really hard-wearing qualities. Sizes: $27 \times 1\frac{1}{4}$.

T308/1505 each 22/-

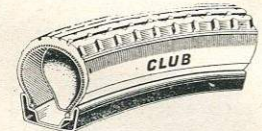

JOHN BULL CLUB

A modestly priced but extremely serviceable "all rounder". Sizes: $26 \times 1\frac{1}{4}$, $1\frac{3}{8}$.

T315/910 each 14/1

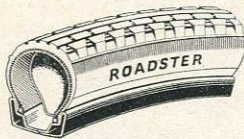

JOHN BULL ROADSTER

Light, flexible and hard wearing. A good, sound tyre for everyday use. Sizes: $26 \times 1\frac{1}{4}$, $1\frac{3}{8}$, $1\frac{1}{2}$.

T304/1010 each 15/5

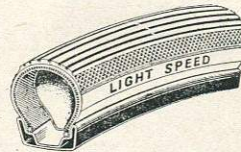

JOHN BULL LIGHT SPEED

Light, fast, hard wearing. The ideal "training" tyre for the racing cyclist. Sizes: $26 \times 1\frac{1}{4}$; $27 \times 1\frac{1}{4}$.

T310/1305 each 19/2

T311/503 H.P. Inner Tube each 7/6

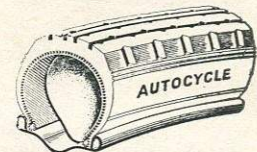

JOHN BULL AUTOCYCLE

Of extra generous construction for more miles of safe, trouble-free riding. Size: $26 \times 2 \times 1\frac{3}{4}$.

T316/1909 each 28/3

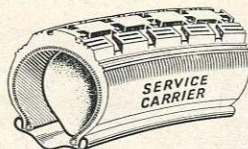

JOHN BULL SERVICE CARRIER

Size: $20 \times 2 \times 1\frac{3}{4}$.

T320/1507 each 22/3

Size: $26 \times 2 \times 1\frac{3}{4}$.

T321/1909 each 28/3

Size: $26 \times 1\frac{3}{4}$.

T322/1505 each 22/-

CLEMENT TUBULAR TYRES

T326/2400 Elvezia each 35/11

T327/2900 Gran Sport each 43/6

T328/3200 No. 48 each 48/-

T329/3600 No. 50 each 54/-

T330/4908 No. 10 each 74/6

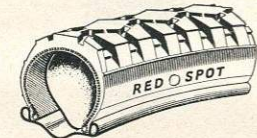

JOHN BULL RED SPOT

Sizes: $26 \times 1\frac{3}{8}$, $1\frac{3}{4}$; $28 \times 1\frac{1}{2}$.

T352/1010 each 15/5

ENGLEBERT H.P. COVERS

T342/1204 27" each 18/6

ENGLEBERT TYRES

T343/2008 Tubular, 27" each 27/6

ENGLEBERT TUBES

T344/311 $\frac{1}{2}$ 27" each 5/11

/300 $26 \times 1\frac{1}{4}$, $26 \times 1\frac{3}{8}$ each 4/6

PARAGON STANDARD ROADSTER

Dutch Made

Black. Sizes: $26 \times 1\frac{1}{4}$; $26 \times 1\frac{3}{8}$.

T348/702 Cover each 10/9

T349/210 Tube (boxed) each 4/3

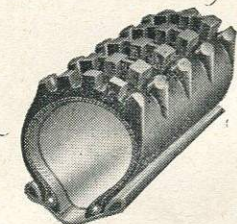

AVON SKIDWAY "GRIPSTER"

For rear wheel use on cycle speedway. Size: $26 \times 1\frac{3}{8}$.

T354/911 each 14/3

MICH TUBULAR
1806 ITALIAN TUBULARS 24/8
~~T324/1704~~ Ventura, 16 oz. each 25/41
~~T325/1908~~ Vega, 12 oz. each 29/6
T321/2108 Vedetta, 13 $\frac{1}{2}$ oz. each 32/6

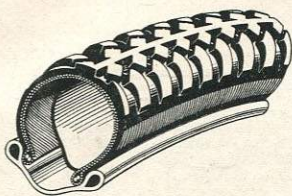

Roadster

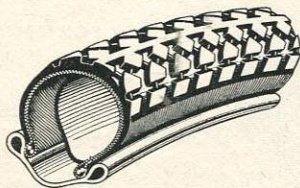

Carrier

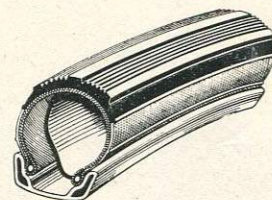

High Speed

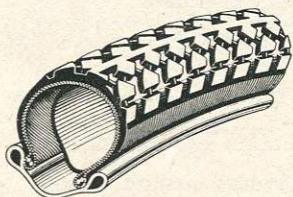

Endurance

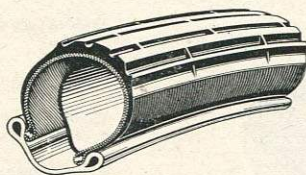

Power Drive

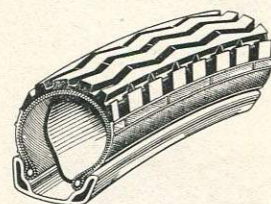

Sports

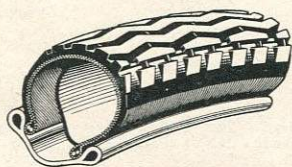

Zigzag

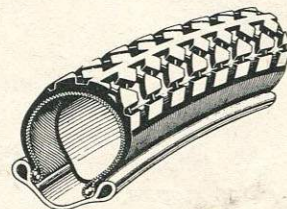
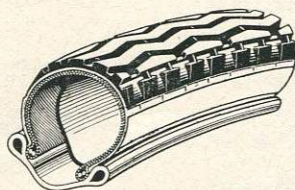

Juvenile

MICHELIN TYRES

Michelin Roadster

26 × 1 1/4	...	/1010	...	each	15/5
26 × 1 3/8	...	/1010	...	each	15/5
26 × 1 1/2	...	/1010	...	each	15/5
28 × 1 1/2	...	/1010	...	each	15/5

Michelin Endurance

26 × 1 1/4	...	/910	...	each	14/1
26 × 1 3/8	...	/910	...	each	14/1
26 × 1 1/2	...	/910	...	each	14/1
28 × 1 1/2	...	/910	...	each	14/1

Michelin Zigzag

26 × 1 1/4	...	/901	...	each	12/11
26 × 1 3/8	...	/901	...	each	12/11
26 × 1 1/2	...	/901	...	each	12/11
28 × 1 1/2	...	/901	...	each	12/11

Michelin Carrier

26 × 1 3/4	...	/1505	...	each	22/-
------------	-----	-------	-----	------	------

MICHELIN TYRES

Michelin Power Drive

26 × 1 3/4	...	/1210	...	each	18/4
*26 × 1 3/4	× 1 1/2	/1505	...	each	22/-

* Fits 26 × 1 1/2 tube.

Michelin White Wall

26 × 1 1/4	...	/910	...	each	14/1
26 × 1 3/8	...	/910	...	each	14/1

Michelin High Speed

26 × 1 1/4	...	/1102	...	each	15/11
*27 × 1 1/4	...	/1102	...	each	15/11

* Translucent or White Wall

Michelin Sports

26 × 1 1/4	...	/910	...	each	14/1
*27 × 1 1/4	...	/910	...	each	14/1

* Translucent or White Wall

Michelin Juvenile

*12 1/2 × 2 1/4	...	/1002	...	each	14/6
14 × 1 1/4	...	/702	...	each	10/3
16 × 1 1/4	...	/702	...	each	10/3
18 × 1 1/4	...	/702	...	each	10/3
20 × 1 1/4	...	/702	...	each	10/3
24 × 1 1/4	...	/901	...	each	12/11

* White Balloon.

MICHELIN TUBES

Michelin Super

26 × 1 1/4	...	/502	...	each	7/4
26 × 1 3/8	...	/502	...	each	7/4
26 × 1 1/2	...	/502	...	each	7/4
28 × 1 1/2	...	/502	...	each	7/4

Michelin High Speed

Presta type Valve

26 × 1 1/4	...	/409	...	each	6/9
27 × 1 1/4	...	/409	...	each	6/9

Michelin Universal

Woods Valve

26 × 1 1/4	...	/406	...	each	6/5
26 × 1 3/8	...	/406	...	each	6/5
26 × 1 1/2	...	/406	...	each	6/5
28 × 1 1/2	...	/406	...	each	6/5

With Schrader Valve

26 × 1 1/4	...	/409	...	each	6/10
26 × 1 3/8	...	/409	...	each	6/10
26 × 1 1/2	...	/409	...	each	6/10
28 × 1 1/2	...	/409	...	each	6/10

Michelin Carrier

Woods Valve

26 × 1 3/4	...	/503	...	each	7/6
With Schrader Valve	...	/507	...	each	7/11

Michelin Juvenile

Woods Valve

14 × 1 1/4	...	/311	...	each	5/7
16 × 1 1/4	...	/311	...	each	5/7
18 × 1 1/4	...	/311	...	each	5/7
20 × 1 1/4	...	/311	...	each	5/7
24 × 1 1/4	...	/406	...	each	6/5

Y H 11

W. G. CHEESE LIMITED
 CYCLE AND MOTOR ACCESSORIES, WIRELESS
 AND ELECTRICAL SUNDRIES

JUPITER HOUSE
 326-327, BRADFORD ST., BIRMINGHAM, 5
 Telephone: MIDland 5804/5 (2 lines)

DUNLOP CYCLES TYRES

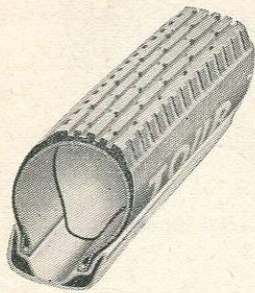

Tourist Sprite

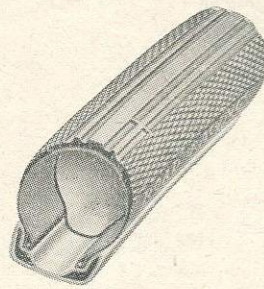

Road Racing (H.P.)

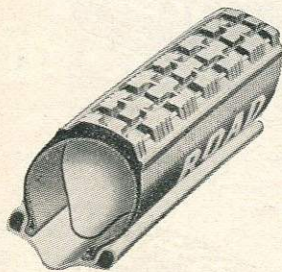

Roadster

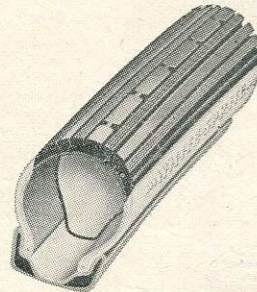

White Sprite

T530/Coded

FOR ROADSTER CYCLES, Etc.

Type of Cover	Nominal Size (inches)	COVER	
		Trade	Retail
DUNLOP TOURIST SPRITE WHITE SIDEWALL ...	26 x 1 1/8 Wired	/1505	22/-
DUNLOP WHITE ROADSTER WHITE SIDEWALL ...	24 x 1 1/8 Wired 26 x 1 1/8 Wired	/1211	18/6
DUNLOP ROADSTER ...	22 x 1 1/8 Wired 24 x 1 1/8 Wired 26 x 1 1/8 Wired 26 x 1 1/8 Wired 28 x 1 1/8 Wired 26 x 1 1/8 Wired 28 x 1 1/8 Beaded	/1010	15/5
		/1300	18/7

DUNLOP CHAMPION WHITE SIDEWALL ...	24 x 1 1/8 Wired	/1010	15/6
---------------------------------------	------------------	-------	------

DUNLOP CHAMPION ...	24 x 1 1/8 Wired 26 x 1 1/8 Wired 26 x 1 1/8 Wired 26 x 1 1/8 Wired 28 x 1 1/8 Wired	/901	12/11
---------------------	--	------	-------

FOR JUNIOR CYCLES, Etc.

Type of Cover	Nominal Size (inches)	COVER	
		Trade	Retail
DUNLOP JUNIOR WHITE SIDEWALL ...	20 x 1 1/8 Wired	/808	12/4
DUNLOP JUNIOR ...	11 x 1 1/8 14 x 1 1/8 Wired 16 x 1 1/8 18 x 1 1/8 Wired 20 x 1 1/8 Wired	/702	10/3
DUNLOP BALLOON ...	12 1/2 x 2 1/4 Wired	/1002	14/6

FOR SMALL CYCLES, PERAMBULATORS, Etc.

Type of Tyre	Nominal Size (inches)	TYRE		Type of Tyre	Nominal Size (inches)	TYRE	
		Trade	Retail			Trade	Retail
DUNLOP CUSHION Triple Stud	14 x 1 1/4	/708	11/-	DUNLOP AIRSPRUNG	12 x 1 1/4	/1204	17/8
Tread	16 x 1 1/4	/810	12/8		14 x 1 1/4	/1110	16/11
Plain	8 x 1 1/4	/500	7/1		16 x 1 1/4	/1300	18/7
Tread	10 x 1 1/4	/507	7/11				

FOR SPORTS CYCLES, Etc.

Type of Cover	Nominal Size (inches)	COVER	
		Trade	Retail
DUNLOP ROAD RACING High Pressure	26 x 1 1/4 Wired ... 27 x 1 1/4 Wired	/1505	22/-
DUNLOP WHITE SPRITE WHITE SIDEWALL	26 x 1 1/4 Wired* 26 x 1 1/8 Wired* 27 x 1 1/4 Wired*	/1305	19/2
DUNLOP SPRITE	26 x 1 1/4 Wired* 26 x 1 1/8 Wired* 27 x 1 1/4 Wired*	/1204	17/8
DUNLOP SPEED WHITE SIDEWALL	26 x 1 1/4 Wired* 26 x 1 1/8 Wired* 27 x 1 1/4 Wired*	/1107	16/7
DUNLOP SPORTS	26 x 1 1/4 Wired* 26 x 1 1/8 Wired* 27 x 1 1/4 Wired*	/910	14/1
DUNLOP TANDEM	26 x 1 3/8 (Wide Section) Wired	/1400	20/-

Dunlop Road Racing (High Pressure) Tyres must be fitted to 'K' Section Rims.
* When fitted on 'K' Section Rim use Dunlop Road Racing Tube.

FOR TRADESMEN'S CARRIER CYCLES, AUTOCYCLES, MOTORISED CYCLES, Etc.

Type of Cover	Nominal Size (inches)	To Fit Rim	COVER	
			Trade	Retail
DUNLOP ...	14 x 2 x 1 1/2 Wired	14 x 1 1/2 (F2J)	/1408	21/-
DUNLOP CARRIER	20 x 2 x 1 1/2 Wired	18 x 1 1/2 (F4J)	/1507	22/3
	20 x 2 1/2 Wired	20 x 2 1/2 (G. Sect.)	/2102	30/3
	26 x 1 1/2 Wired	26 x 1 1/2 (F9)	/1505	22/-
	26 x 1 3/8 Wired	26 x 1 3/8 (F12)	/1505	22/-
	26 x 2 x 1 1/2 Wired	26 x 1 3/8 (F12)	/1909	28/3
	26 x 2 x 1 1/2 Oversize Wired	26 x 1 3/8 (F12)		
DUNLOP CARRIER "R"	12 1/2 x 2 1/4 Wired	12 1/2 x 2 1/4 (G1J)	/2004	29/1
DUNLOP MOTORETTE	26 x 1 3/8 Wired	26 x 1 3/8 (EA3 & F4)	/1400	20/-
	26 x 1 3/8 x 1 1/2 Wired	26 x 1 1/2 (F9)	/1505	22/-

27" TUBULAR RACING TYRES

Type of Tyre	TYRE		Type of Tyre	TYRE	
	Trade	Retail		Trade	Retail
No. 0 ...	/4611	£3 7 0	No. 9 ...	/2909	£2 2 6
No. 1 ...	/4904	£3 10 6	No. 10 ...	/2909	£2 2 6
No. 2 ...	/4904	£3 10 6	SILK		
No. 3 ...	/4904	£3 10 6	No. 0 ...	/7105	£5 2 0
No. 5 ...	/4904	£3 10 6	No. 2 ...	/7411	£5 7 0
No. 8 ...	/3710	£2 14 0	No. 5 ...	/7411	£5 7 0

DUNLOP CYCLE TUBES

Type of Tube	Size	TUBE	
		Trade	Retail
DUNLOP AIRSEAL	22 x 1 1/8 24 x 1 1/8 26 x 1 1/8 26 x 1 1/8 26 x 1 1/8 26 x 1 1/8 28 x 1 1/8 27 x 1 1/8 27 x 1 1/8 †	/502	7/4
DUNLOP CHAMPION AIRSEAL	24 x 1 1/8 26 x 1 1/8 26 x 1 1/8 26 x 1 1/8 26 x 1 1/8 28 x 1 1/8 27 x 1 1/8 †	/406	6/5
DUNLOP JUNIOR AIRSEAL	11 x 1 1/8 14 x 1 1/8 16 x 1 1/8 18 x 1 1/8	/400	5/8
DUNLOP TANDEM AIRSEAL	26 x 1 3/8	/502	7/4
DUNLOP CARRIER AIRSEAL	14 x 2 x 1 1/2 20 x 2 x 1 1/2 20 x 2 1/2 26 x 1 1/2* 26 x 1 1/2 26 x 2 x 1 1/2 12 1/2 x 2 1/4	/406 /502 /509 /509 /503 /503 /511	6/5 7/4 8/2 8/2 7/6 7/6 8/5
DUNLOP MOTORETTE AIRSEAL	26 x 1 3/8* 26 x 1 3/8 x 1 1/2*	/504	7/7
DUNLOP BALLOON AIRSEAL	12 1/2 x 2 1/4 (4116 Valve)*	/604	9/-
DUNLOP ROAD RACING (HIGH PRESSURE)	26 x 1 1/4 † 27 x 1 1/4 †	/502	7/4

All Dunlop Tubes are fitted with Dunlop Easypump Valves unless otherwise indicated. Specify Schrader Valves when ordering Dunlop Carrier Tubes for fitment to autocycles and motorised cycles. Extra charge for fitting Schrader Valves: Trade 5d.; Retail 7d. each.

Tubes marked with an asterisk* are fitted with a Schrader Valve at the inclusive price. †These Tubes are fitted with Dunlop Cycle Racing Valves.

H 15

W. G. CHEESE LIMITED
CYCLE AND MOTOR ACCESSORIES, WIRELESS
AND ELECTRICAL SUNDRIES

JUPITER HOUSE
326-327, BRADFORD ST., BIRMINGHAM, 5
Telephone: MIDland 5804/5 (2 lines)



STURMEY-ARCHER WHEELS WITH THREE OR FOUR-SPEED HUBS

Ref. A.W. Standard Wide Ratio Three-speed Wheel with "Flick" Trigger or Top Tube Control.
W27/5107 each 71/2

Ref. F.W. Standard Wide Ratio Four-speed Wheel with "Flick" Trigger Control.
W31/5400 each 74/7

Ref. F.M. Medium Ratio Four-speed Wheel fitted with Alloy Shell, "Flick" Trigger Control, Wing Nuts and Splined Sprocket.
W10/5107 each 71/2

Ref. A.B. Wheel incorporating AW Hub with Internal Expanding Brake and Rod Control.
W11/6403 each 88/8

Ref. F.G. Wheel incorporating FW Hub with patent six-volt Dynohub.
W12/8909 each 123/10

Ref. B.F. Wheel incorporating Front Hub with Internal Expanding Brake and Rod Control.
W13/3706 each 51/7

Ref. B.R.C. Wheel incorporating Single-speed Hub with Internal Expanding Brake and Cable Control.
W14/3908 each 54/7

Ref. A.B.C. Wheel incorporating AW Hub with Internal Expanding Brake and Cable Control.
W15/6403 each 88/8

Ref. A.G. Wheel incorporating AW Hub with patent six-volt Dynohub.
W40/8506 each 118/-

Ref. B.R. Wheel incorporating Rear Single-speed Hub with Internal Expanding Brake and Rod Control.
W41/3908 each 54/7

Ref. G.H.6. Wheel incorporating patent six-volt Dynohub.
W42/5611 each 78/4

Ref. B.F.C. Wheel incorporating Internal Expanding Brake and Cable Control.
W43/3706 each 51/7

JUVENILE WHEELS

14", 16", 18", 20" × 1 3/8". Chromium plated.
W45/1304 Front each 20/-
W46/1404 Rear each 21/6

SPECIAL WHEELS MADE TO ORDER

Quotations on receipt of requirement details.

CARRIER WHEELS

Best quality Westward Carrier Rims, 26" × 1 3/8", 14 gauge spokes and B.W. or Brampton Hubs. Black enamelled.
W50/3003 per pair /-/
W51/1409 Front only each /-/
W52/1506 Rear only each /-/
 14" or 20" Front.
W53/1409 each /-/

H.P. STEEL

26" or 27". 15/17 gauge spokes.
W62/2106 Front. Resilion each 32/3
W63/2400 Rear. Resilion each 36/-
W64/1906 Front. B.W. 51 each 29/3
W65/2006 Rear. B.W. 310 each 30/9
W70/2600 Racelite. Front each 39/-
W72/2909 Racelite. Rear each 44/6

STANDARD WHEELS

Front. Westwood. 24", 26". Chromium plated.
W18/1403 each 21/3

Front Endrick. 26". Chromium plated.
W19/1403 each 21/3

Rear. Westwood. 24", 26". Chromium plated.
W20/1506 each 23/3

Rear Endrick. 24", 26", 27". Chromium plated. Double Fixed.
W21/1600 each 24/-

Gear and Fixed (310).
W22/1703 each 25/9

Extra for 28" wheels.
W23/001 each extra 2d.

Resilion Endrick. 26", 27".
W25/1806 Front each 27/9
W26/2100 Rear each 31/6

D 109

W. G. CHEESE LIMITED
 CYCLE AND MOTOR ACCESSORIES, WIRELESS
 AND ELECTRICAL SUNDRIES

JUPITER HOUSE
 326-327, BRADFORD ST., BIRMINGHAM, 5
 Telephone: MIDland 5804/5 (2 lines)

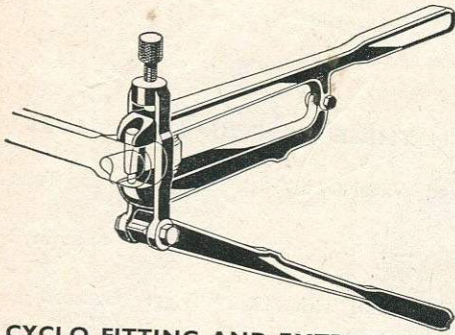

CYCLO FITTING AND EXTRACTING TOOL
 No. 147. For Crank Cotter Pins.
 W100/Trade each 33/-



CYCLO NEW STANDARD PEDAL TAP
 No. 120. R. and L., double-ended.
 W101/Trade each 7/8



CYCLO FORK COLUMN CUTTER DIE REDUCER
 No. 127. Will reduce 1" butted part of column to $\frac{31}{32}$ " cutting size.
 W102/Trade each 11/6

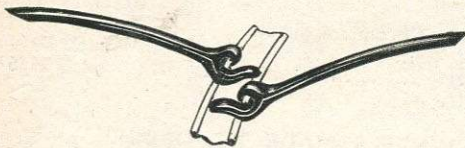

"ROSA" RIM TRUERS
 No. 132. For Westwood type rims.
 W103/Trade per pair 7/8

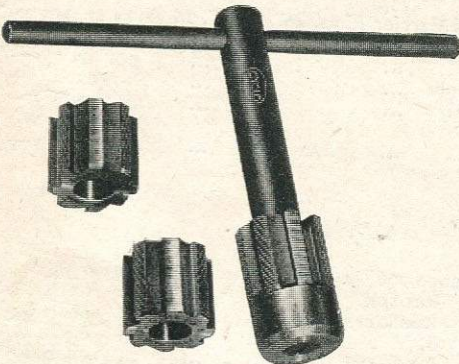

CYCLO BOTTOM BRACKET CLEARING TAP
 No. 123. R. and L. hand thread, $1\frac{3}{8}$ " x 24T.
 W104/Trade each 12/1

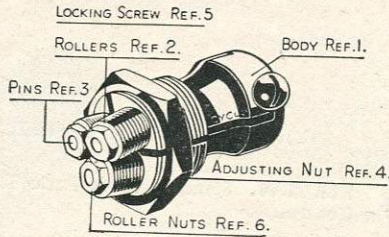

CYCLO SPOKE THREAD ROLLING HEADS

No. 155. The rollers are correctly set at 14G. unless otherwise specified. Enables threads to be easily rolled on both 14 and 15 gauge cycle spokes.
 W110/Trade each 22/-

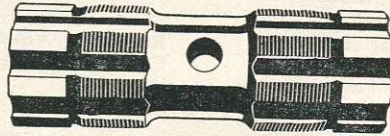

CYCLO BRACKET TAP
 No. 124. Double-ended $1\frac{3}{8}$ " x 24 thread.
 W112/Trade each 19/3



CYCLO HEXAGON DIE NUTS
 No. 128. Made in sizes: $\frac{3}{16}$ " x 32 thread; $\frac{1}{4}$ " x 20 thread, 26 and 30 thread; $\frac{5}{16}$ " and $\frac{3}{8}$ " x 26 thread.
 W114/Trade each 5/6

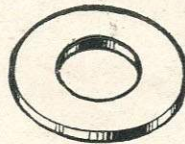

STEEL CYCLE WASHERS
 Plated Steel. Each size packed 1 gross in box.
 W129/104 Size $\frac{3}{16}$ " ... per gross 2/-
 W130/108 Size $\frac{1}{4}$ " ... per gross 2/6
 W131/205 Size $1\frac{5}{16}$ " ... per gross 3/8
 W132/207 Size $\frac{3}{8}$ " ... per gross 3/11
 Assorted sizes $\frac{3}{16}$ " to $\frac{1}{2}$ ".
 W133/206 per gross 3/9

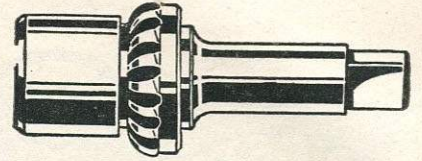

CYCLO HEAD LUG REAMER
 No. 119. Standard type complete with holder and revolving guide.
 W118/Trade each 24/2

No. 119C. Head Lug Cutter only.
 W120/Trade each 13/9



CYCLO CRANK TAP AND REAMER
 No. 125. For rebushing cranks, R. and L.
 W120/Trade each 14/4



CYCLO FORK COLUMN DIES
 No. 116/D. Made in: Standard B.S.A. size $\frac{31}{32}$ " x 30 thread; 1" x 24 thread; 1" x 26 thread, and Juvenile sizes $\frac{7}{8}$ " x 24, 26 or 30 thread.
 W122/Trade each 11/6
 No. 109/B. Tandem Die only, Standard Brampton size $1\frac{1}{8}$ " x 26 thread.
 W124/Trade each 15/11



CYCLO CRANK TRUEING TOOL
 No. 157. 14" handle giving ample leverage. Steel drop forging.
 W126/Trade each 8/3

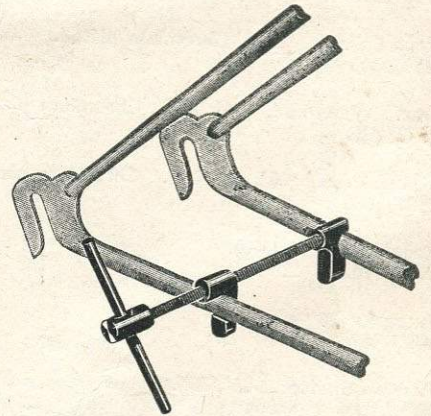

"ROSA" IMPROVED FORK EXPANDER
 No. 133.
 W128/Trade each 8/3

A 1 40

COMPRISING . . .

MOTOR CYCLE AND MOPED SECTION

- **BULBS**
- **BATTERIES**
- **BRAKE LINERS**
- **CLOTHING**
- **GLOVES**
- **GOGGLES**
- **GREASE GUNS**
- **HELMETS**
- **LAMPS**
- **MIRRORS**
- **OILS**
- **POLISHES**
- **SPARKING PLUGS**
- **SPEEDOMETERS**
- **TOOLS**
- **TYRES**
- **WINDSCREENS**

C 6

W. G. CHEESE LIMITED
CYCLE AND MOTOR ACCESSORIES, WIRELESS
AND ELECTRICAL SUNDRIES

JUPITER HOUSE
326-327, BRADFORD ST., BIRMINGHAM, 5
Telephone: MIDland 5804/5 (2 lines)

86 BULBS, BATTERIES, SUNDRIES

SPLENDOR MOTOR CYCLE AND CAR BULBS

MB40/Coded

British Prefocus Headlights.
Double filament. Each

312/209	6v. 30/24w.	Clear Bulb ...	5/-
306/206	6v. 36/36w.	Clear Bulb ...	4/6
354/206	12v. 42/36w.	Clear Bulb ...	4/6

Headlights, 38mm. Double filament.

171/111	12v. 36/36w.	"T" filament ...	3/6
---------	--------------	------------------	-----

Stop and Tail and Flashing Indicator Bulbs

384/2300 doz.	6v. 18/6w.	S.B.C. ...	3/6
380/2300 doz.	12v. 21/6w.	S.B.C. ...	3/6

Side and Tail Bulbs. 18mm. Clear.

200/809 doz.	6v. 3w.	S.C.C. ...	1/4
205/1000 doz.	6v. 6w.	S.C.C. ...	1/6
207/809 doz.	12v. 6w.	S.C.C. ...	1/4
209/809 doz.	12v. 6w.	S.B.C. ...	1/4

Side, Tail or Indicator Bulbs. 15 mm. Clear.

988/903 doz.	6v. 3w.	M.C.C. ...	1/5
951/1006 doz.	6v. 6w.	M.C.C. ...	1/7
986/703 doz.	12v. 2-2w.	M.E.S. ...	1/1
989/903 doz.	12v. 6w.	M.C.C. ...	1/5

All Bulb Prices Plus Purchase Tax.

Scooter Headlamp Bulb. 6v. 15/15w.

/306	each 5/3
------	-----	-----	----------

Plus Purchase Tax 10d.

Parking Lamp Bulb, screw in. 12v. 2-2w.

/800 doz.	each 1/-
-----------	-----	-----	----------

Plus Purchase Tax 1/11 Doz.

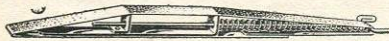

CONTACT MASTER DISTRIBUTOR POINT CLEANERS

A simple and efficient way to clean magneto points. 6 on card.

MB70/800 card	each 2/-
---------------	-----	-----	----------



HEYBERD BATTERY CHARGERS

No. A.O.21. Popular Model. Charges 2-volt, 6-volt or 12-volt batteries at 1 amp.

MB50/5806	each 78/-
-----------	-----	-----	-----------



HEYBERD BATTERY CHARGERS

No. A.O.23. Charges 6-volt or 12-volt batteries at 3 amps. and 2 volts at 1 amp.

MB58/7611	each 102/6
-----------	-----	-----	------------

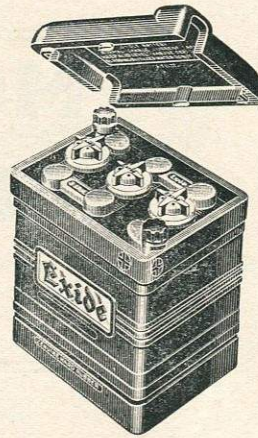

EXIDE BATTERIES

Model 3ER7L. Square type 3ER7L 6 volt 12 amp. at 10 hr. rate. Length, $6\frac{3}{16}'' \times 3\frac{9}{16}'' \times 6\frac{3}{8}''$.

MB53/3300.	Dry	...	each 44/-
MB54/111.	Charging extra	...	each 2/6

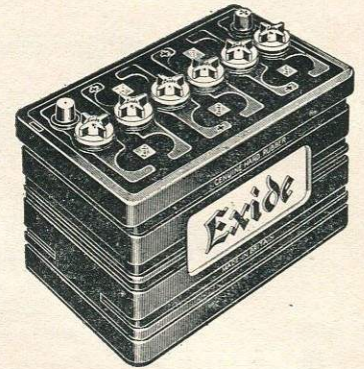

EXIDE CAR BATTERIES STANDARD or DOUBLE LIFE DRY or FILLED and CHARGED PRICES ON APPLICATION

Please Give Details of Car.



EXIDE HYDROMETER

Syringe Type for testing specific gravity of electrolyte.

MB60/606	each 8/8
----------	-----	-----	----------



STADIUM HYDROMETER

MB62/304	each 5/-
----------	-----	-----	----------

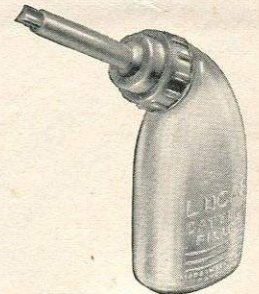

LUCAS BATTERY FILLER

Small Size.
MB63/208

each 3/6

Large Size.
MB64/402

each 5/6

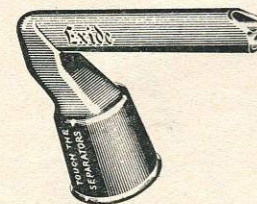

EXIDE TOPPING-UP SPOUT

Made in a tough plastic material and is flexible. Will fit most common bottles of about one to one-and-a-half pint size.

MB65/201	each 2/9
----------	----------

M 28

W. G. CHEESE LIMITED
CYCLE AND MOTOR ACCESSORIES, WIRELESS
AND ELECTRICAL SUNDRIES

JUPITER HOUSE
326-327, BRADFORD ST., BIRMINGHAM, 5
Telephone: MIDland 5804/5 (2 lines)

FIBRAX BRAKE LINERS FOR MOTORIZED CYCLES AND MOPEDS

Supplied in Cartonned Sets, complete with Rivets. MB120/M

Make	Model	Year	Location	Dimensions	Set No.	Per Set
B.S.A.	98cc.		F or R	$4\frac{1}{2} \times \frac{3}{4} \times \frac{1}{4}$ "	PCL/27/1	6/5 D.
	Winged Wheel	1955/57	R	$4\frac{1}{2} \times \frac{3}{8} \times \frac{1}{4}$ "	PCL/56	7/2 D.
Berini	49cc. M.21	1956/58	F	$3\frac{3}{4} \times \frac{3}{8} \times \frac{1}{4}$ "	PCL/19	5/- D.
	47cc. Hohner	1956/58	F. or R.	$1\frac{1}{2} \times 1\frac{1}{2} \times 4\frac{3}{4}$ "	PCL/65	6/8 D.
Binetta	47cc. Lachs	1956/58	F	$9\frac{1}{2} \times 16 \times 4\frac{3}{4}$ "	PCL/40	6/- D.
			R.	$9\frac{1}{2} \times 20 \times 4\frac{3}{4}$ "	PCL/47	6/4 D.
Bond	Minibyk	1950/57	F. or R.	$4\frac{1}{2} \times \frac{3}{4} \times \frac{1}{4}$ "	PCL/27/1	6/5 D.
	49cc. Hummel	1956/57	F. or R.	$1\frac{1}{2} \times 1\frac{1}{2} \times 3\frac{3}{4}$ "	PCL/78	5/2 U.
D.K.W.	49cc.	1956/59	F. or R.	$1\frac{1}{2} \times 1\frac{1}{2} \times 3\frac{3}{4}$ "	PCL/90	5/8 U.
		1955/58	F. or R.	$4\frac{1}{2} \times \frac{3}{4} \times \frac{1}{4}$ "	PCL/49	4/6 D.
Ducati	49cc. 55/E	1955/58	F.	$1\frac{1}{2} \times 1\frac{1}{2} \times 3\frac{3}{4}$ "	PCL/41	7/9 D.
	Douglas-Vespa	1950/59	R.	$1\frac{1}{2} \times 2\frac{1}{2} \times 3\frac{3}{4}$ "	PCL/42	8/7 D.
Douglas-Vespa	125cc. G, GL2 and G	1955/59	F.	$1\frac{1}{2} \times 2\frac{1}{2} \times 5\frac{3}{4}$ "	PCL/43	10/5 D.
	125cc. GL2, 42L2	1953/55	R.	$1\frac{1}{2} \times 2\frac{1}{2} \times 5\frac{3}{4}$ "	PCL/43/2	10/5 D.
Excelsior	150cc. GS.	1955/59	F. or R.	$1\frac{1}{2} \times 2\frac{1}{2} \times 4\frac{3}{4}$ "	PCL/58	11/8 D.
	Skutabyk	1957/59	F.	$4\frac{1}{2} \times \frac{3}{4} \times \frac{1}{4}$ "	PCL/27/2	6/5 D.
			R.	$5 \times \frac{7}{8} \times \frac{1}{8}$ "	PCL/61	7/9 D.

Make	Model	Year	Location	Dimensions	Set No.	Per Set
Heinkel	49cc. Perle	1956/58	F. or R.	$86 \times 16 \times 3\frac{3}{4}$ "	PCL/64	4/6 U.
	49cc.	1957/58	F. or R.	$122 \times 16 \times 4\frac{3}{4}$ "	PCL/89	6/10 D.
Lambretta	123cc. LC, LD	1952/59	F.	$120 \times 15 \times 4\frac{3}{4}$ "	PCL/50	7/2 D.
	150cc. LDB and LD	1954/59	R.	$130 \times 20 \times 4\frac{3}{4}$ "	PCL/37	9/2 D.
Leopard	124cc and 140cc LL	1959	F. or R.	$155 \times 25 \times 4\frac{3}{4}$ "	PCL/108	11/3 D.
	175cc. TV	1959	F.			
N.S.U.	175cc. TV	1959	R.	$155 \times 25 \times 4\frac{3}{4}$ "	PCL/108	11/3 D.
	47cc. Bobby	1956/59	F. or R.	$92 \times 20 \times 4\frac{3}{4}$ "	PCL/47	6/4 D.
Norman	49cc. Quickly	1956/59	F. or R.	$95 \times 16 \times 4\frac{3}{4}$ "	PCL/40	6/- D.
	47cc. Nippy	1957/59	F. or R.	$4\frac{1}{2} \times \frac{3}{4} \times \frac{1}{4}$ "	PCL/27/1	6/5 D.
Phillips	Gadabout 3"	1955 on	F.	$3\frac{3}{4} \times \frac{1}{2} \times \frac{1}{8}$ "	PCL/63	6/1 D.
	Puch	1955/58	F. or R.	$85 \times 20 \times 4\frac{3}{4}$ "	PCL/72	5/10 U.
Raleigh	Moped	1959	F. or R.	$3\frac{1}{8} \times \frac{3}{8} \times \frac{1}{8}$ "	PCL/15	5/- D.
	Hornet Mk. V	1949/56	F. or R.	$4\frac{1}{2} \times \frac{3}{4} \times \frac{1}{8}$ "	PCL/27/3	6/8 D.
Sun	50cc. Fips	1955/57	F. or R.	$92 \times 20 \times 4\frac{3}{4}$ "	PCL/47	6/4 D.
	47cc. Nicky	1956/59	F. or R.	$92 \times 20 \times 4\frac{3}{4}$ "	PCL/47	6/4 D.



RENOLD MARK 10 MOTOR CYCLE CHAINS

For Machines from 250cc. upwards.	MC72/G	Retail per foot
No. 110038. Simple Roller.	$\frac{3}{8}$ " pitch by $\frac{7}{32}$ " inside width	6/9
No. 110044. Simple Roller.	$\frac{3}{8}$ " pitch by $\frac{3}{16}$ " inside width	10/2
No. 110046. Simple Roller.	$\frac{3}{8}$ " pitch by $\frac{5}{16}$ " inside width	10/2
No. 110054. Simple Roller.	$\frac{3}{8}$ " pitch by $\frac{1}{4}$ " inside width	11/11
No. 110056. Simple Roller.	$\frac{3}{8}$ " pitch by $\frac{3}{8}$ " inside width	11/11

RENOLD CHAIN FOR MOTORIZED CYCLES

No. 112045. 120 Pitches.	$\frac{1}{2}$ " pitch by $\frac{3}{16}$ " inside width.	
MC74/906	...	each 14/3

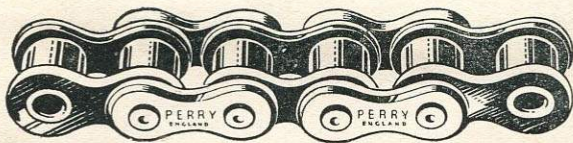

PERRY MOTOR CYCLE CHAINS "53"

No. 11506		
MC78/407. Simple Roller.	$\frac{3}{8}$ " pitch by .155" inside width	per foot 6/1
No. 12008.		
MC79/610. Simple Roller.	$\frac{1}{2}$ " pitch by .205" inside width	9/2

PERRY MOPED CHAIN

120 L. $\frac{1}{2}$ " x $\frac{3}{16}$ " H.D.	
MC80/808	each 13/-



RENOLD SPARE PARTS KITS For Mark 10 Motor Cycle Chains

Each Kit contains: One Inner Link, Two Single Connecting Links, Three Spring Clip Fasteners and One Double Cranked Link.

No. 690001. For $\frac{1}{2}$ " x $\frac{3}{16}$ " Chains.	No. 690002. For $\frac{1}{2}$ " x $\frac{5}{16}$ " Chains.
MC85/308	per kit 4/10½
No. 690005. For $\frac{5}{8}$ " x $\frac{1}{4}$ " Chains.	No. 690006. For $\frac{5}{8}$ " x $\frac{3}{8}$ " Chains.
MC86/502	per kit 6/10

RENOLD MARK 10 CHAIN LINKS

MC87/Coded	No. 26 Connecting Link Single		No. 30 Double Cranked Link	
	Trade doz.		Trade doz.	
$\frac{3}{8}$ " pitch by $\frac{5}{32}$ " inside width	...	/402	6/9	
$\frac{3}{8}$ " pitch by $\frac{7}{32}$ " inside width	...	/402	6/9	
$\frac{3}{8}$ " pitch by $\frac{3}{16}$ " inside width	...	/710	13/6	
$\frac{3}{8}$ " pitch by $\frac{5}{16}$ " inside width	...	/710	13/6	
$\frac{3}{8}$ " pitch by $\frac{1}{4}$ " inside width	...	/1100	19/2	
$\frac{3}{8}$ " pitch by $\frac{3}{8}$ " inside width	...	/1100	19/2	

PERRY "53" MOTOR CYCLE CHAIN SPARES

No. 6. $\frac{1}{2}$ " Chain. Connecting Links.	
MC90/706	each 10d.
No. 10. $\frac{1}{2}$ " Chain. Double Cranked Links.	
MC91/1209	each 1/5
No. 6. $\frac{5}{8}$ " Chain. Connecting Links.	
MC92/1000	each 1/1½
No. 10. $\frac{5}{8}$ " Chain. Double Cranked Links.	
MC93/1703	each 1/11

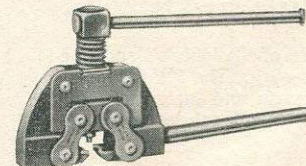

RENOLD UNIVERSAL CHAIN RIVET EXTRACTOR

MC94/1206. No. 311 006	each 16/7
------------------------	-----------

W. G. CHEESE LIMITED
CYCLE AND MOTOR ACCESSORIES, WIRELESS
AND ELECTRICAL SUNDRIES

JUPITER HOUSE
326-327, BRADFORD ST., BIRMINGHAM, 5
Telephone: MIDland 5804/5 (2 lines)

**"RADSPORT" HURRICANE
MOTOR CYCLE SUIT**

A 100% waterproof, black, two-piece suit of durable P.V.C. material with warm lining, giving complete all-weather protection. Sizes: Small chest, 32"-34". Medium chest, 36"-38". Large chest, 40"-42".

Complete Suit.
MC175/8400 each £6 6 0
Plus Purchase Tax 4/-

Coat only.
MC176/5309 each £4 1 0
Plus Purchase Tax 2/6

Trousers only.
MC177/3009 each £2 6 0
Plus Purchase Tax 1/6



**"RADSPORT"
MOPED SCOOTER SUIT**

A 100% waterproof, black, two-piece suit of durable P.V.C. material, with warm lining, 2 pockets, and belted full zipp jacket. Elasticated top, easy slip-on trousers. Sturdy yet light. Sizes: Small and Large.

Complete Suit.
MC196/6309 each 95/9
Plus Purchase Tax 3/-

Coat only.
MC198/3703 each 56/-
Plus Purchase Tax 1/9

Trousers only.
MC199/2606 each 39/9
Plus Purchase Tax 1/3

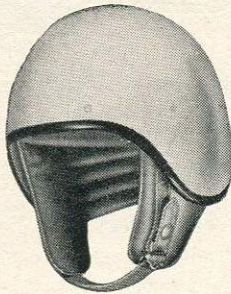

STADIUM SAFETY HELMET

Project III Space Helmet. Moulded in strong fibre glass, lined with laminated cork. Silver finish. Headband lined with soft foam padding, finished with soft leather.

MC180/5000 each 75/-

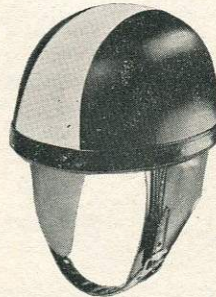

FLASH SAFETY HELMET

MC187/2809 each 42/6



STADIUM HELMETS

The Cruiser. A peakless helmet made from "Polyfibre" and lined with 1/4" of laminated cork, also includes P.V.C. harness with temple protection pads, quick release buckles and a securing loop for goggles.

No. 244W. White. each 46/6
MC200/3100
No. 244B. Black. each 46/6
MC201/3100



STADIUM HELMETS

The Clipper. Made of "Polyfibre" and lined with 1/4" of laminated cork. The P.V.C. harness is lined with soft satin and includes temple protection pads, with quick-release press stud fastening.

No. 245W. White. each 51/6
MC182/3404
No. 245B. Black. each 51/6
MC183/3404

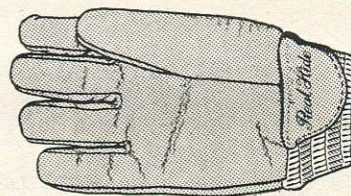

GLOVES

No. DG14GB. Fully fingered elastic wrist gloves in Tan or Yellow coated leather. Warm fleece lining throughout hand and wrist. Sizes: Medium and large.

MC189/1206 per pair 16/9
Plus Purchase Tax 6d.

No. DG14B. Boys and Youths. All hide elastic wrist gloves. Fleece lined throughout hand and wrist. Tan. Sizes: Medium and Large.

MC194/1106 24.04 per pair 15/9
Plus Purchase Tax 6d. 1/11

BEST GAINLOTS

34/6

GLOVES

No. 14T. Boys. Tan. Fully fingered elastic wrist gloves, fleece lining throughout hand and wrist.

MC206/1106 per pair 16/6
Plus Purchase Tax

GLOVES

No. 14Y. Yellow. Fully fingered elastic wrist gloves, fleece lining throughout hand and wrist.

MC210/1206 per pair 16/9
Plus Purchase Tax 6d.

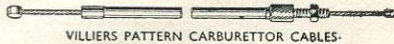

VILLIERS PATTERN CARBURETTOR CABLES



B.S.A. BANTAM PATT. FRONT BRAKE CABLE 1/2 ADJUSTER

CLARK'S CONTROL CABLES FOR MOPEDS

SUITABLE REPLACEMENT FOR:													Clark's Ref. No.	MC55/Coded Complete Assembly
Quickly Mk. I and Mk. II														
Throttle, Mk. I	1422/109	2/8
Throttle, Mk. II	2423/109	2/4
Clutch	3424/107	2/4
Front Brake	4425/207	3/9
Gear Change	5425/206	3/0
Exhaust	5426/103	1/10
Quickly Model L														
Throttle	5621/105	2/2
Clutch	5622/109	2/8
Front Brake	5623/109	2/8
Gear Change	5624/201	3/2
Decompressor	5627/109	2/8
Quickly Models N and S														
Front Brake	5626/109	2/8
Raleigh Mark I Moped														
Throttle	5711/105	2/2
Front Brake	5713/201	3/2
Decompressor	5717/105	2/2
Rear Brake	5718/208	4/-
Mobylette De Luxe														
Throttle	5731/105	2/2
Front Brake	5733/101	1/7
Decompressor	5737/105	2/2
Rear Brake	5738/109	2/8
Choke	5739/105	2/2

All Prices plus 5%

Equipment and Vehicle Manufacturers' Part Nos. and Names are used for Reference Purposes only.

ADDITIONAL CABLES

H 68

W. G. CHEESE LIMITED
 CYCLE AND MOTOR ACCESSORIES, WIRELESS
 AND ELECTRICAL SUNDRIES

JUPITER HOUSE
 326-327, BRADFORD ST., BIRMINGHAM, 5
 Telephone: MIDland 5804/5 (2 lines)

90 FOOTREST, FORKS, HEATERS & JOINTINGS



GASKET GOO

Tubes. Twelve per display card.
 MJ30/1200 doz. ... per tube 1/6

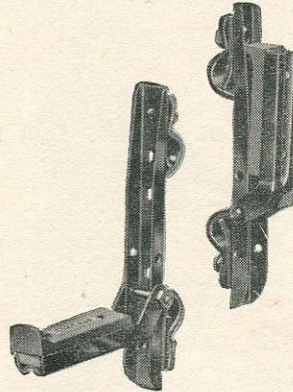

LYCETT PILLION FOOTRESTS

No. S16. Adjustable and folding. The rubber rest is securely riveted to the steel frame, which is fitted with two universal clips. Size: 8 3/8" high x 5 1/2" wide (open).
 MF12/600 ... per pair 9/-



OSOTITE JOINTING CEMENT

Twelve tins per carton.
 MJ40/200 ... each 3/-



BOSTIK ADHESIVES

No. 252. Properties similar to Bostik C.
 MJ33/204 Large Tube ... each 3/6



WEBB SPRING FORKS FOR MOTOR-ASSISTED CYCLES

Standard. Column length, 8". Length of thread, 3". T.P.I. 24.
 Model No. 824B. Black.
 MF14/5405 each £3 15 0
 Model 824S. Silver.
 MF15/5405 each £3 15 0
 Long Column. Column length, 10". Length of thread, 3". T.P.I. 24.
 Model 1024B. Black.
 MF16/5405 each £3 15 0



BOSTIK SEALING COMPOUNDS

No. 692. In tubes. Non-inflammable. For sealing leaky windscreens, windows, etc., and for general sealing purposes to motor vehicles.
 MJ42/204 Large Tube ... each 3/6

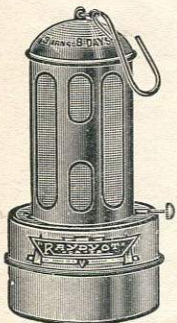

RAYDYOT "EIGHT-DAY" OIL HEATER

No. H505. Burns for 8 days consecutively without attention on one filling of paraffin. Finish: Gold Enamel and Blue.
 MH20/1202 each 17/5
 Plus Purchase Tax 3/-



DESMO HANGING HEATER
 No. 58B. Will burn for 250 hours with one filling. Incorporates an outside flame regulator and hook. Paraffin.
 MH24/1203 each 17/6
 Plus Purchase Tax 2/11

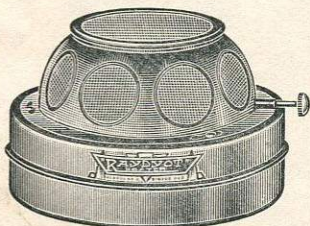

RAYDYOT "DUALETTE" HEATER

No. H81. Diameter of base 9 1/2". Overall height 6". Burning capacity approx. 200 hours. Paraffin.
 MH22/1606 ... each 23/8
 Plus Purchase Tax 4/-

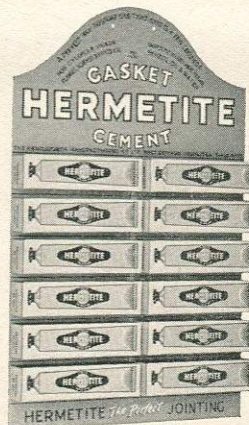

HERMETITE LIQUID JOINTING

Tubes, one dozen on display card.
 MJ36/1408 card ... per tube 1/10

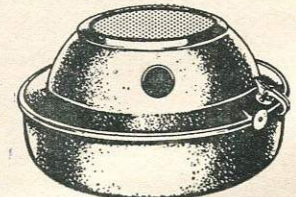

DESMO UNIVERSAL SUMP HEATER

No. 126B. One filling of 4 pints paraffin gives 250 hours' burning. Outside flame regulator; double heat; low cone burner; heavy gauge materials throughout.
 MH26/1610 ... each 24/-
 Plus Purchase Tax 4/1



STADIUM FEATHERWEIGHT GOGGLE

No. 366. Made from pliable, clear transparent P.V.C. material. The featherweight frame holds exchangeable acetate lenses giving clear and wide vision. Adjustable elastic headband. Specially suitable for users of motorised bicycles.
MG57/204 each 3/6

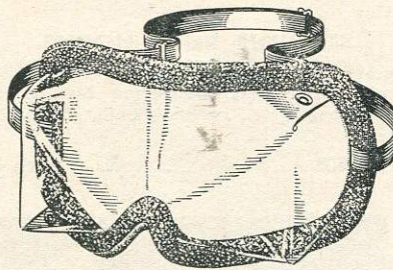

STADIUM SAFETY EYESHIELDS

Non-inflammable eyeshields bound with soft chenille and fitted with adjustable elastic headband. Can be worn over spectacles.
No. 314. Large. Approximate size 7½" x 4".
MG49/110 each 2/9

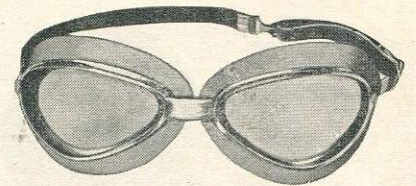

STADIUM LIGHTWEIGHT GOGGLES No. 356. With Plastic Lenses. Aluminium non-rust goggles with sponge-rubber eye-cups and non-inflammable curved lenses. Fitted with adjustable quick-release elastic headband and metal-covered elastic nose-bridge. Replacement lenses snap easily into frame.
MG64/308 per pair 5/6

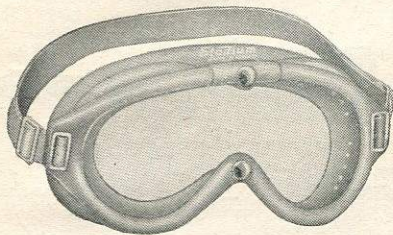

STADIUM "VISTA" GOGGLES

No. 343. Designed for flush fitting to the face and unimpaired vision. Scientific ventilation prevents steaming. Two press studs secure unbreakable non-inflammable windows and allow easy replacement.
MG59/508 per pair 8/6
No. 343/RL. Spare windows for above in Clear, Orange or Green.
MG60/010 each 1/3

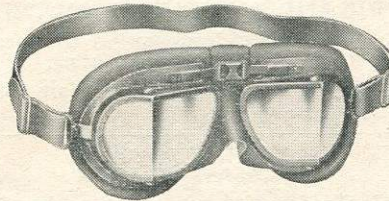

STADIUM POPULAR SERVICE GOGGLES

Mark VIII. Clear laminated glass lenses. Soft leather face mask, padded with sponge rubber. Adjustable nosebridge and elastic headband.
MG53/1809 per pair 25/-

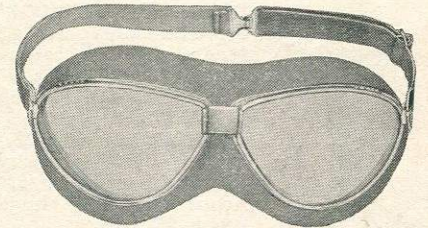

STADIUM WIDE VISION GOGGLES No. 363. Moulded rubber mask and with plastic lenses. Ventilated aluminium frame with domed non-inflammable plastic lenses and metal-covered elastic nosebridge. Quick-release elastic headband. Fits over spectacles.
MG65/502 each 7/9

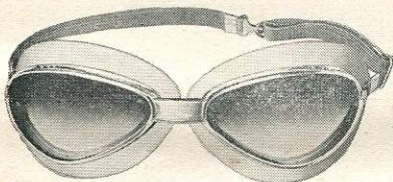

STADIUM LIGHTWEIGHT GOGGLES NI. 355G. Similar to No. 356, but has lenses which graduate from a restful deep green at the top edge to clear at the lower edge. Scientific protection from glaring sun and dazzling headlights.
MG62/402 per pair 6/3

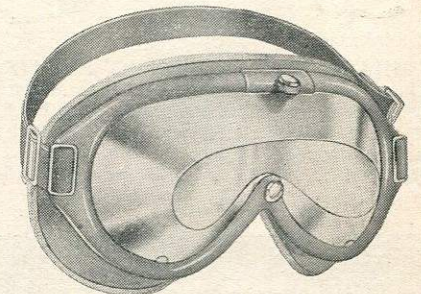

STADIUM "VISTA" RAIN GOGGLES No. 335. Specially shaped aperture lens gives clear vision in rain and snow, eliminating drop reflections at night. Fits every face, even over spectacles. Clear transparent.
MG66/804 each 12/6

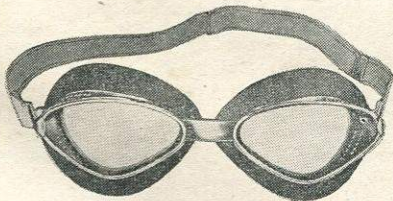

STADIUM FULL VIEW GOGGLES No. 202. With Triplex Laminated Glass Lenses. Aluminium frames with sponge-rubber eye-cups. Sliding clips permit easy exchange of glasses. Adjustable elastic headband.
MG51/1000 per pair 15/-

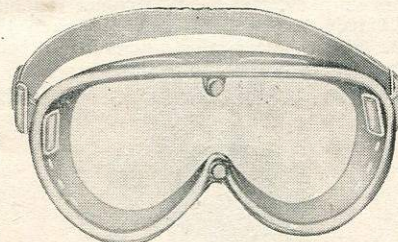

STADIUM "VISTA" JUNIOR GOGGLES No. 344. Wide-vision P.V.C. goggle. Two press studs firmly secure non-inflammable exchangeable windows which are available in Clear, Orange and Green anti-glare tints. Adjustable elastic headband.
MG63/500 each 7/6

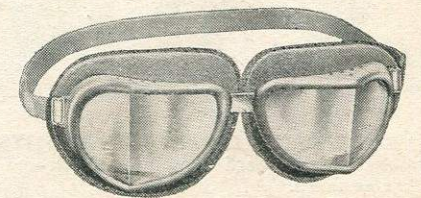

STADIUM MARK X GOGGLES No. 356. With Plastic Lenses. Aluminium non-rust goggles with sponge-rubber eye-cups and non-inflammable curved lenses. Fitted with adjustable quick-release elastic headband and metal-covered elastic nose-bridge. Replacement lenses snap easily into frame.
MG64/308 per pair 5/6

O 45

W. G. CHEESE LIMITED
 CYCLE AND MOTOR ACCESSORIES, WIRELESS
 AND ELECTRICAL SUNDRIES

JUPITER HOUSE
 326-327, BRADFORD ST., BIRMINGHAM, 5
 Telephone: MIDland 5804/5 (2 lines)

CLEARHOOTER ELECTRIC HORNS

No. HF140. Light-weight high-frequency horns designed for motor cycles, electric vehicles and small cars. Finished in Ebony Black and Chrome. 6-volt or 12-volt.
MH28/1302
 each 19/9

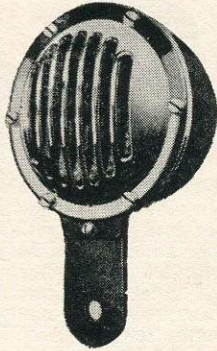

STADIUM BULB HORNS

No. 110C. Plated finish. Strong steel bracket. Suitable for cycles, motorised bicycles and motor cycles. Red or Black bulb. Chromium plated.
MH29/508 each 8/6

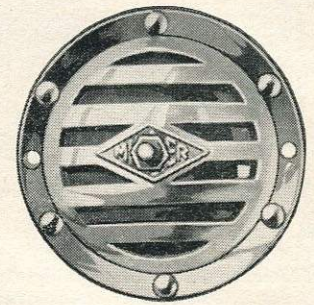
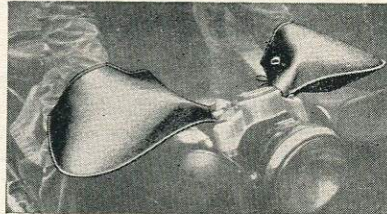

MILLER A.C. HORNS

Specially suitable for Mopeds. With switch.
MH30/1000 each 15/-



NUBEX GREASE GUN

No. 501/0/PO.
MG53/608 each 9/9



DUNLOP "JUNIOR" SINGLE LIFT JACKS

Model LJ/2. Capacity, 8 cwt. Closed height, 7". Actual lift, 4 1/2". Handle length, 18".
MJ20/1606... each 22/-
 Model LJ/5. Capacity, 15 cwt. Closed height, 5 1/2". Actual lift, 5 7/8". Handle length, 18".
MJ21/2109... each 29/-

MIDLAND HANDLEBAR MUFFS

No. 4771. Made of hard-wearing waterproof leathercloth, felt padded and fleecy lined. Special cut-outs on off-side for control cables. Lace fitting.
MH31/1505 per pair 23/1

MIDLAND HANDLEBAR MUFFS

No. 1388. Made of hard-wearing, waterproof material. Fleece lined. Strap fitting.
MH32/1103 per pair 16/10

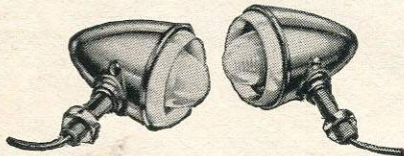

MILLER TWIN PARKING LIGHTS

Chromium plated on brass, and mounted either side of the headlamps with 3/8" x 26T.P.I. 1" fixing bolts. Fitted with 6v. 3w. M.E.S. bulbs and cable.
ML2/904 per pair 14/-

HACKSAW BLADES

MH36/Trade 10" per doz. 5/-
MH37/Trade 12" per doz. 6/3



MILLER MOTOR CYCLE REAR LAMPS

No. 37ET. Incorporating a reflector and fitted with 6v. 6w. S.C.C. bayonet cap bulb.
ML5/1000 each 15/-
 No. 38ET. A stop-tail lamp similar to above but fitted with a 6v. 18/6w. bulb.
ML6/1108 each 17/6

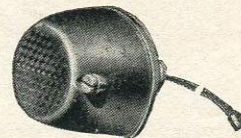

MILLER MOTOR CYCLE REAR LAMP

Model 39E. Incorporates reflector and fitted with 6v. 6w. S.C.C. bayonet cap bulb.
ML8/508 each 8/6

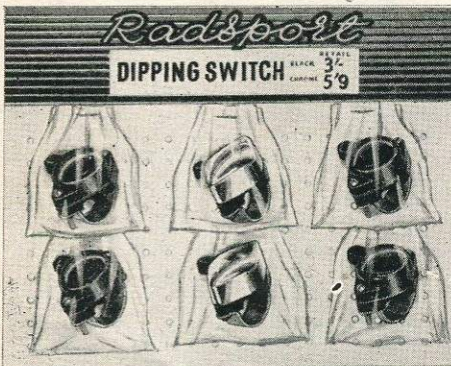

"RADSPORT" DIPPING SWITCHES

Precise action. Card contains 4 Black and 2 Chrome finish.
ML3/1508 card each 3/-
ML4/-/ card Chrome each 5/9



ERSIN MULTICORE SOLDER

Packets. Packed 1-gross packets per case.
MH39/400-doz. per packet 6d.

TINMAN'S SOLDER

Sticks approximately 8 ozs. weight.
MH40/Trade each 3/8

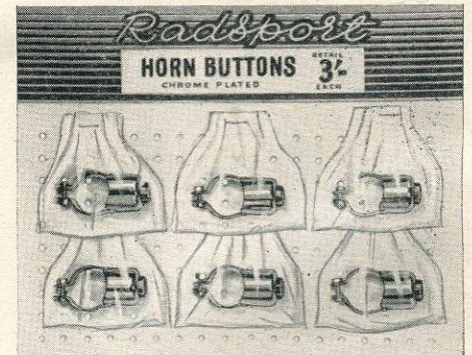

"RADSPORT" HORN BUTTONS

Superior Chrome finish. 6 per card.
ML10/1200 card each 3/-

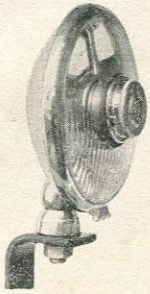

BUTLER'S "SAUCER" SPOT, FOG AND PASS LAMPS

Diameter 6¼". Bolt centre to back 7⁄8". Overall depth 3½". 12-volt or 6-volt pre-focused bulb. All Chrome.

- No. 1468/K. Pass and Spot. ... each 53/6
- ML22/4000 ... each 53/6
- No. 1468/J. Fog (Amber). ... each 55/6
- ML23/4106 ... each 55/6
- No. 1468/C. Fog or Spot (Clear). ... each 53/6
- ML24/4000 ... each 53/6



MILLER SPOT LAMPS

No. 40S. Fully chromium plated on brass with adjustable bracket for 7⁄8" or 1" bars. 4¼" dia. and fitted with 6v. 30w. bulb.

- ML35/2000 ... each 30/-
- No. 40F. Similar to above but fitted with amber fog lamp glass. ... each 30/-
- ML36/2000 ... each 30/-

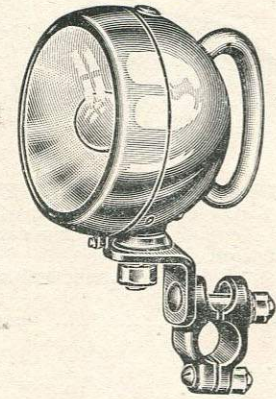

RAYDYOT MOTOR CYCLE SPOT LAMPS

No. HL15. With 4¾" flush-fitting front. Made of non-ferrous metals. Full universal adjustment available and clip to fit either 7⁄8" or 1" handlebars. Silvered reflector, adjustable focus, bulb and flex included. Chrome body and front, silver enamel fittings.

- ML51/3002 ... each 45/2
- No. HL16. Same specification as Model HL15, with the addition of chrome-plated handle at back for easy manipulation. ... each 47/3
- ML52/3106 ... each 47/3

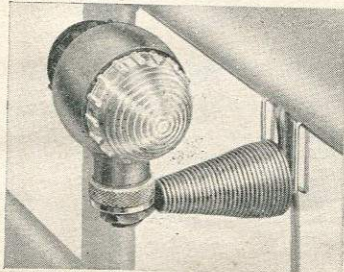

STARLITE PARKING LIGHT

No. 1308. Chrome-plated conical spring window fitting. Supplied with 6 ft. twin cable. Less bulb.

- ML54/700 ... each 10/6

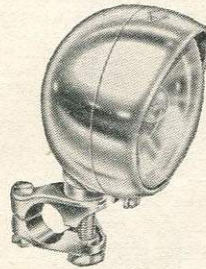

MILLER SPOT LAMPS

No. 44S. Ideal for Scooters and motor cycles. Fitted with adjustable ball joint for 7⁄8" or 1" handlebars or crashbars. 4¼" dia. 6v. 30w. bulb.

- ML39/2108 ... each 32/6
- No. 44F. Similar to above but fitted with amber glass. ... each 32/6
- ML40/2108 ... each 32/6

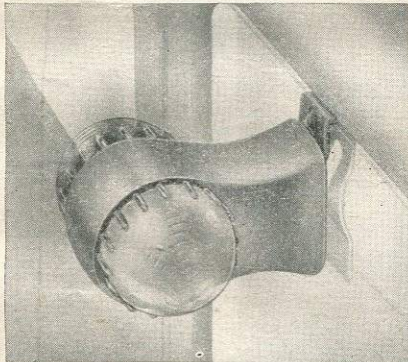

STARLITE CAR PARKING LIGHT

No. 1293. Hooks on the window glass, wind up the window and the light is secured. No screws or holes needed. Operated from car battery or from independent dry or wet batteries, any voltage. Complete with 1½" dia. Red and White Domes and 6 ft. of cable.

- ML55/500 ... each 7/6

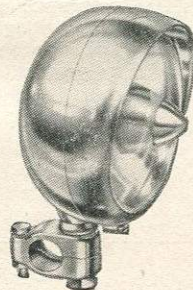

MILLER SPOT LAMPS

No. 54SM. Chromium plated with adjustable ball joint bracket, for 7⁄8" or 1" bars. 5¼" dia. Fitted chromium-plated bulb cowl. 6v. 36w. bulb.

- ML44/2904 ... each 44/-
- No. 54FM. As above but fitted with yellow fluted fog glass giving flat topped spread beam. ... each 45/-
- ML45/3000 ... each 45/-

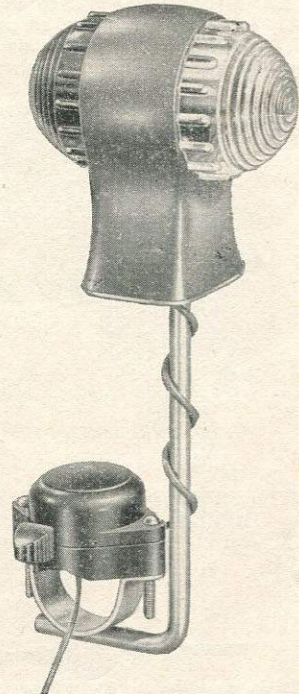

STARLITE MOTOR CYCLE PARKING LIGHT

No. 1304. Supplied complete with 1½" Red and Clear Lens. Bracket adjustable for 7⁄8" or 1" Bars and attractive switch. Overall height 6¼". Operated from motor cycle battery or independent wet or dry battery, any voltage. Supplied less bulb. Individually boxed.

- ML30/710 ... each 11/9
- Spare domes available for all models.

J 123

W. G. CHEESE LIMITED
CYCLE AND MOTOR ACCESSORIES, WIRELESS
AND ELECTRICAL SUNDRIES

JUPITER HOUSE
326-327, BRADFORD ST., BIRMINGHAM, 5
Telephone: MIDland 5804/5 (2 lines)



BRITAX "REFLECTOLITE"
 Combined Stop and Tail Light Unit, with large clear panel for number plate illumination and integral reflector.
No. E52. With double filament bulb and snap connectors.
 ML/111/804 each 12/6

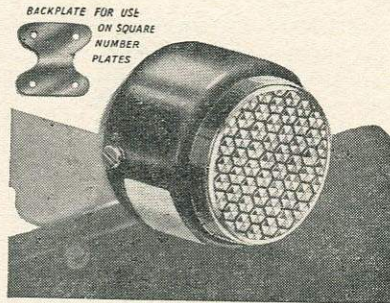

STADIUM NUMBER PLATE REAR LIGHT

No. 553. Complies with latest lighting regulations. Efficient rear light for scooters, power assisted cycles, and "Mopeds". With 1 3/4" bright red plastic lens and large window for number plate illumination. Bulb holder and contact incorporated in rubber plug. Can easily be withdrawn to allow exchange of bulbs. The screw positions and special back plate allow easiest possible fitment to all types of number plates. Complete with bulb.
 ML118/308 each 5/6

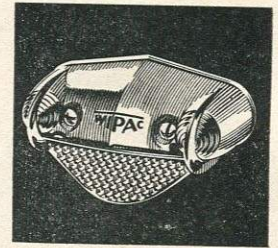

WIPAC "3 BULB" STOP AND REAR LAMP

Series 143.
No. S0088. Suitable for cars and motor cycles. Incorporates three bulbs, one for rear lighting and two for stop warning lights. Bulbs are flexibly mounted for longer life. Complete with bulbs.
 ML127/1300 each 19/6

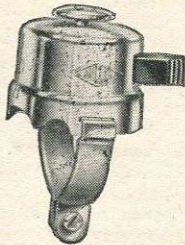

MILLER HANDLEBAR SWITCH
No. HB1. A moped switch to control the lights (Off, Main and Dip), the horn and cut-out. Chromium plated on brass and supplied with all instructions.
 ML113/400 each 6/-

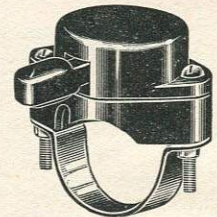

RAYDYOT DIPPING SWITCH
 Dipping Switch for cars or motor cycles. Clip fits either 7/8" or 1" bar.
No. S21. Black finish.
 ML133/110 each 2/9
No. S23. Chrome finish.
 ML134/310 each 5/9

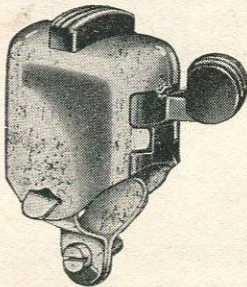

STADIUM COMBINED HORN AND DIPPER SWITCH
No. 828. Effectively combines both purposes.
 ML114/404 each 6/6

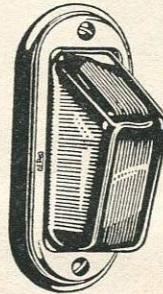

DESMO STOP AND TAIL LAMP
No. 2031. Designed for mudguard or body fitting to meet the new lighting regulations. Heavily chromium-plated rim and red glass lens. Complete with twin bulbs.
 ML122/1002 each 13/6



MILLER DIP AND HORN SWITCH
No. 157HV. Chromium-plated cover, horn button and fixing straps, for 7/8" or 1" bars.
 ML138/400 each 6/-
No. 157. Dip switch similar to above but less the horn button.
 ML139/308 each 5/6

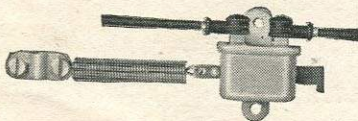

MILLER STOP SWITCH
No. 43E. Fitted with clamps to fit bars of 3/4", 7/8" and 1" dia. Complete with tension spring, brake rod clamp, chrome-plated sliding rod and cadmium-plated body.
 ML115/308 each 5/6

KAYAY "REARGUARD"

Streamline design with fitted reflector, finished in chrome. Clip fits most exhaust pipes.
 ML123/808 each 12/11

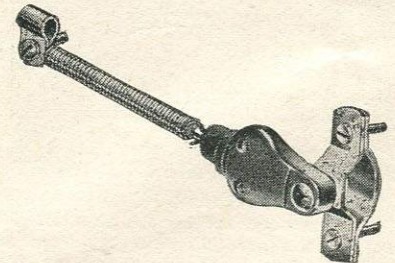

STADIUM STOPLIGHT SWITCH
No. 802. For general motor cycle use.
 ML140/300 each 4/6

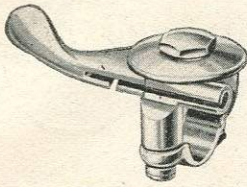

DOHERTY MAGNETO CONTROL LEVERS

No. 100. R.H. or L.H. Length 2 1/4". Diameter 7/8" or 1". Pull 1 5/8".
ML170/504 each 8/-

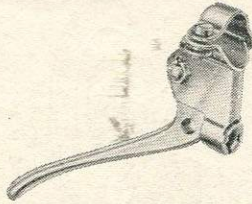

DOHERTY BRAKE OR CLUTCH LEVERS

No. 402. Specially suitable for lightweight motor cycles. Length 4 1/2". R.H. or L.H. Diameter 7/8" or 1". Pull 5/8".
ML174/508 each 8/6

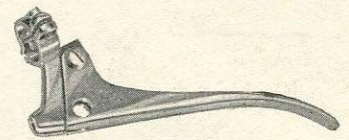

DOHERTY CLUTCH LEVERS

No. 107P. Pressed type lever. Length 6". R.H. or L.H. Diameter 7/8" or 1". Pull 7/8".
ML193/508 each 8/6

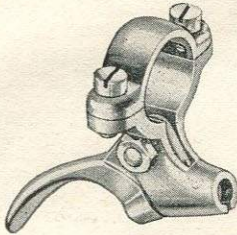

DOHERTY DECOMPRESSION LEVERS

No. 106. Specially designed for two-stroke engines, particularly where a small movement is required. Made from solid stampings. Will fit all standard handlebars. Length 2". Diameter 7/8" or 1". Pull 3/8".
ML172/411 each 7/4

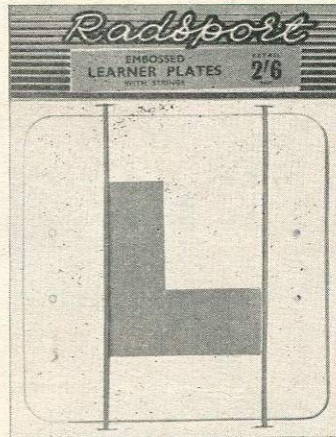

"RADSPORT" L PLATES

With strings. 12 pairs per card.
L179/1800 card per pair 2/6

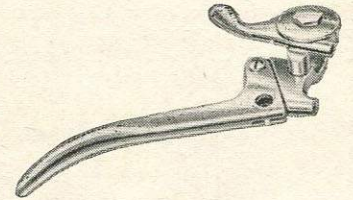

DOHERTY COMBINATION CONTROL LEVERS

No. 100/107P. Combined Magneto and Clutch controls. Designed to give correct position for each lever. Length 6". R.H. or L.H. Diameter 7/8" or 1". Pull 7/8".
ML195/1004 each 15/6

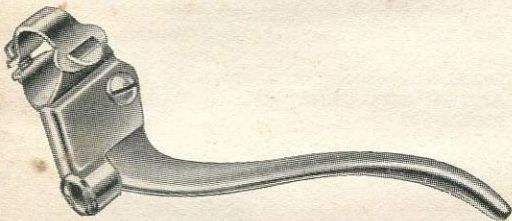

DOHERTY BRAKE OR CLUTCH LEVERS

No. 302. Pressed steel body. Length 4 1/2". R.H. or L.H. Dia. 7/8" or 1". Pull 1 5/8".
ML177/500 each 7/6



MILLER LICENCE HOLDER

No. 402. Black enamelled back with brass, chromium-plated rim.
ML186/108 each 2/6
No. 403. As above but less strap and with centre fixing hole.
ML187/108 each 2/6

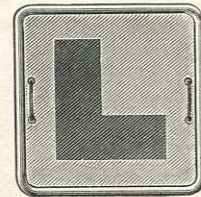

HUMBROL LEARNER PLATES

Completely water-proof.
ML189/008 per pair 1/-

SELF-ADHESIVE "L" PLATES

ML190/1600 doz. pairs each 2/-

NUSTIKON LICENCE HOLDER

No. 877. Complete with St. Christopher Badge. Walnut or Black.

ML199/200 each 3/-



RAYDYOT LICENCE HOLDER

No. LH23. Centre-hole fitting. Chromium rim, silver back.

ML191/2000 doz. each 2/6



DESMO MOTOR CYCLE LICENCE HOLDER

No. 874. Rubber.
ML200/109 each 2/8

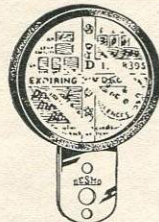

RAYDYOT LICENCE HOLDER

No. LH31. Flat tongue fitting. Chromium rim, silver back.

ML193/2200 doz. each 2/9

MCE

KAYAY LICENCE HOLDER

ML178/1606 each 2/-

W. G. CHEESE LIMITED
CYCLE AND MOTOR ACCESSORIES, WIRELESS AND ELECTRICAL SUNDRIES

JUPITER HOUSE
326-327, BRADFORD ST., BIRMINGHAM, 5
Telephone: MIDland 5804/5 (2 lines)

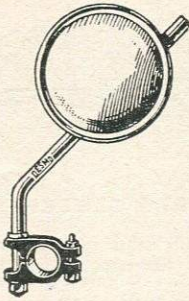

DESMO MOTOR CYCLE MIRROR

No. 21A. Convex glass, 3½" diameter. Chromium and Silver finish.
MM12/1103 each 15/-

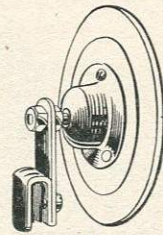

STADIUM MIRROR

No. 282. Motor cycle or scooter windscreen mirror, 3" dia. Lightweight polythene mounting for perspex screens. Ball joint for maximum adjustment, controlled by 3 screws. Chromium-plated clip for fitting to sides or top of screen, no drilling required.
MM27/304 each 5/-

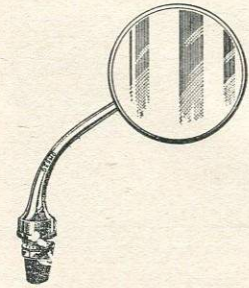

DESMO BOOMERANG WING MIRROR

No. 169. Wing fitting, returns to original position if knocked. Chromium-plated finish.
MM30/1408 Flat Glass each 22/-
MM31/1504 Convex Glass each 23/-

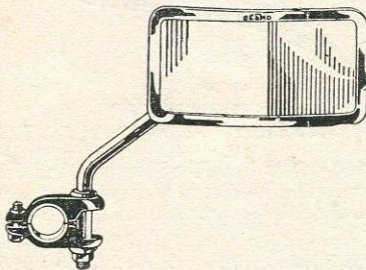

DESMO MOTOR CYCLE MIRROR

No. 21B. Convex glass, 4¾" x 2⅝". Length of arm, 10", with ⅞" or 1" clip. Chromium and Silver finish.
MM14/1205 each 16/6

STADIUM MOTOR CYCLE WINDSCREEN MIRROR

No. 284. With clip fitting. Chromium plated.
MM26/206 each 3/9

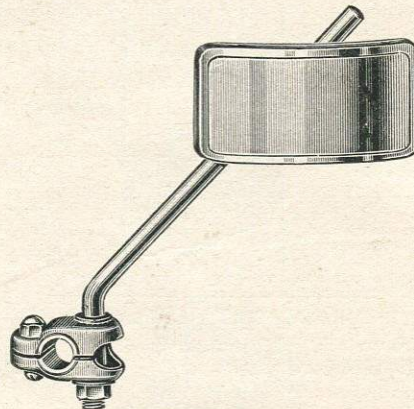

RAYDYOT MOTOR CYCLE MIRRORS

Rectangular convex glass, 4½" x 2½". ⅞"-1" handlebar clip. Universal adjustment.
M7. Black and Chrome.
MM41/1010 each 16/3
M70. All Chrome.
MM42/1608 each 25/-

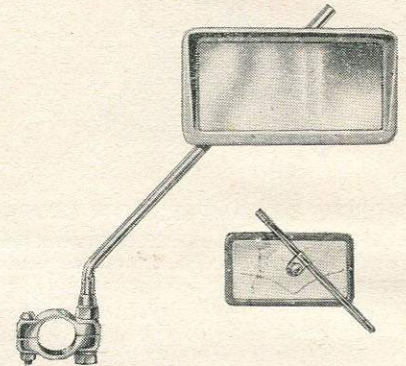

STADIUM SCOOTER MIRROR

No. 297. Two-tone polythene housing, non-rusting and lightweight. Curved, weather-proof, wide vision mirror and fully adjustable. Arm 11" long. Mirror 4⅝".
MM28/700 each 10/6

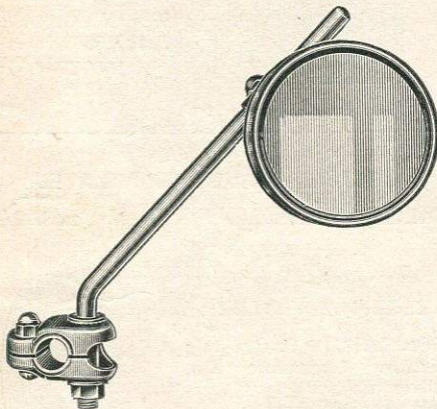

RAYDYOT MOTOR CYCLE MIRRORS

4" diameter, ⅞"-1" handlebar clip and universal adjustment.
Flat Glass
M5. Black and Chrome.
MM16/806 each 12/8
M50. All Chrome.
MM17/1408 each 22/-
Convex Glass
M6. Black and Chrome.
MM18/1002 each 15/3
M60. All Chrome.
MM19/1600 each 24/-

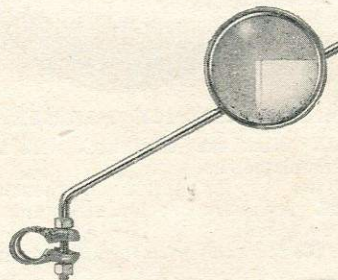

ACUMEN MOTOR CYCLE MIRROR

MM34/310 Nickel plated each 5/9

LYVIA MOTOR CYCLE HANDLEBAR MIRROR

No. 150. Oblong.
MM22/508 each 8/6
 No. 145. Round.
MM23/508 each 8/6

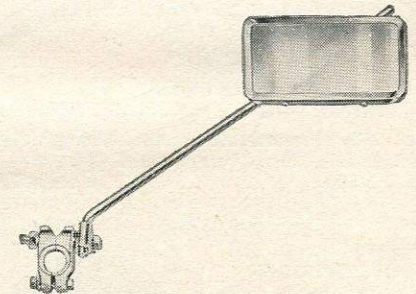

STADIOSCOPE OBLONG MIRRORS

No. 294B. Chromium-plated front rim and Silver enamelled housing. Convex glass, 4½" x 2½". Chromium-plated bracket fits ⅞" and 1" handlebars.
MM44/1008 each 16/-

STADIOSCOPE ROUND MIRROR

No. 296B. Convex 4" diameter mirror, chromium-plated front rim, back and arm. Chromium-plated bracket fits ⅞" and 1" handlebars. Length of arm, 14".
MM46/1000 each 15/-

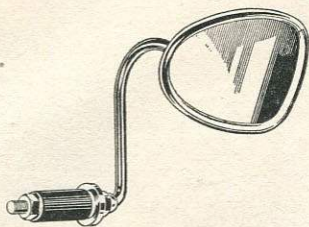

OCTOPUS MOPED MIRROR

No. 11. With patent expanding rubber grip to fit inside $\frac{7}{8}$ " bends. C.P. with latest style pear-shaped head for maximum visibility.

MM50/804 each 12/6

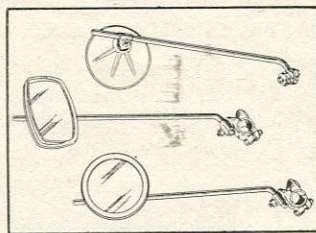

M.P.C.

"GAY-PLAS" SCOOTER MIRROR

Convex glass, 5" x 3", handlebar fitting on 12" extension. Coloured polythene back, hooded to deflect rain from mirror. Colours: Blue, Grey, Red and Cream.

MM52/708 each 11/6

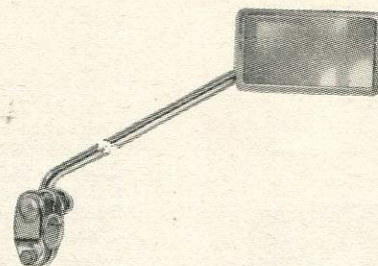

MOTOPLAS OBLONG MIRROR

Ref. No. RM2. The mirror is fitted with extra long rod (13 $\frac{1}{2}$ ") and sturdy handlebar fittings suitable for either $\frac{7}{8}$ " or 1" bars. All chrome plate finish.

Fittings available: Standard N.S.U. Prima, Lambretta, Mark III.

MM56/1204 each 18/6

Ref. No. R.M.1. As above but round, convex mirror. Chromium.

MM57/1110 each 17/9



SPEEDWELL FRONT NUMBER PLATES

No. N.P.21. For motorised bicycles. With handlebar clips. Enamelled.

MN14/Trade per doz. 17/8

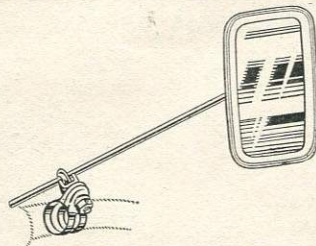

NOVALUX MOPED MIRROR

Chromium plated.

MM54/404 each 6/6

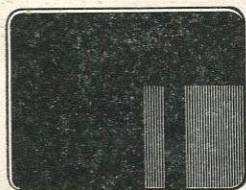

SPEEDWELL REAR NUMBER PLATES

No. N.P.22. For motorised bicycles. 7 $\frac{1}{2}$ " x 6". Suitable for engine, carrier or mudguard mounting. Enamelled.

MN16/Trade per doz. 12/-



MIDLAND FRONT NUMBER PLATES

No. 4898. For motorised bicycles. With handlebar fittings. Black enamel finish. Cadmium-plated fittings.

MN32/200 each 3/-



SPEEDWELL FRONT NUMBER PLATES

No. N.P.13c. Streamlined type for motor cycles. Regulation size, 11" x 2 $\frac{1}{2}$ ". Enamelled.

MN22/Trade per doz. 10/8



MIDLAND REAR NUMBER PLATES

No. 99. For motorised bicycles. Black enamel finish.

MN34/200 each 3/-

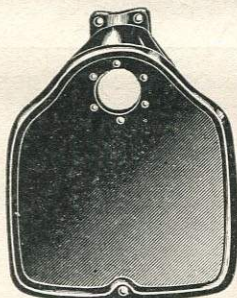

SPEEDWELL REAR NUMBER PLATES

No. N.P.20. Streamlined type for motor cycles. Enamelled.

MN18/Trade per doz. 34/8



BLUEMEL'S EMBOSSED ALUMINIUM ALLOY REGISTRATION PLATES

For motorised cycles, front plate has two clips for handlebar, rear plate has 1" lamp hole at top.

MN24/Trade per pair 13/9

Alloy Blank Plates for Motorised Cycles.

MN26/409 per pair 7/3

HILL'S NUMBER PLATES FOR MOTOR-ASSISTED CYCLES

Die pressed lightweight aluminium plates.

MN28/909 per pair 13/-

Flexwyt digits on Dural beadless plates with or without lamp extension.

MN29/900 per pair 12/-

SPEEDWELL FRONT STUDS FOR NUMBER PLATES

MN20/Trade per doz. pairs /-/-



MIDLAND MOTOR CYCLE MUDFLAPS

No. 4823. Manufactured from best quality black rubber. Supplied complete with metal reinforcement, nuts and bolts for attaching to the mudguard.

MM59/306 each 5/3



CASTROL ENGINE OILS				ML501/Coded		
43-Gall.				1	Quart	Pint
Light	10 or 12	5	1	Tin	Tin	Tin
Steel	Gallon	Gallon	Gallon	Tin	Tin	Tin
Drum	Drum	Drum	Tin	Tin	Tin	Tin
Castrol Z
Castrolite
Castrol XL
Castrol XXL
Castrol Grand Prix
Castrol Two-Stroke
Castrol CR10, 20, 30, 40
Castrol CR20W/30
Castrol R
	23/11	24/9	25/-	26/2	7/-	3/9½
	/2102	/2111	/2202	/2209	/509	/301
CASTROL GEAR OILS						
Castrol ST
Castrol D
	12/6	13/4	13/6	15/3	4/3	2/5½
	/1008	/1105	/1108	/1209	/303½	/111½



CASTROLEASE GREASES				28 lb.	7 lb.	1 lb.	1 lb.
				Keg	Tin	Con-	Tube
				or Pail		tainer	
*Castrolease CL	40/-	11/7	2/8	3/8
*Castrolease Medium	/3500	/910	/201	/300½
*Castrolease Heavy				
Castrolease WB				
Castrolease Unijoynt	40/-	11/7	2/8	—
Castrolease Water Pump	/3500	/910	/201	—
Castrolease PH				
*Castrolease Graphited				
*Castrolease LM	46/3	13/3	2/10	—
				/4008	/1103	/203½	

*Supplied in "Pushdown" packs.



WAKEFIELD'S EVERYMAN'S CYCLE OIL
 7½ oz. spouted tins in cases of 12.
 ML505/1200 doz. each 1/6

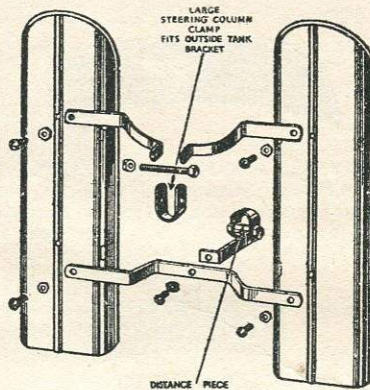

LEG SHIELDS
 Suitable for Raleigh Moped.
 ML515/1806 ... per pair 27/9

PANDA LEG SHIELDS
 ML516/1806 ... per pair 27/9

JAP GADABOUT LEG SHIELDS
 ML157/1806 ... per pair 27/9

LOCKHEED HYDRAULIC BRAKE FLUID			
No. KL70531.	8-oz. tin.	...	each 4/-
ML524/300
No. KL70532.	16-oz. tin.	...	each 6/7
ML525/411
No. KL70533.	32-oz. tin.	...	each 12/-
ML526/900
No. KL70534.	128-oz. tin.	...	each 41/10
ML527/3105



EXCELENE LUBRICATING OIL
 Ideal for cycles, sewing machines, lawn mowers and general household requisites. Quantities of 6 doz. 7½-oz. tins may be overprinted with dealer's name and address at no extra charge.
 ML520/800 doz. 4-oz. tins ... each 1/-
 ML521/1008 doz. 7½-oz. tins ... each 1/4

TINS OF MEDIUM GREASE				
ML522/108	1 lb.	2/3
ML523/102	½ lb.	1/9



JENOGRAPH GRAPHITE GREASE
 Supplied in tubes, carded in dozens.
 ML518/1800 doz. ... each 2/3

CYCLE OILS

Spur. 8 oz. bottles.	each 1/-
ML508/704
Spur. 7½ oz. tins.	each 1/4
ML509/1008

RALEIGH OIL
 7½ oz. Spouted rectangular tins.
 ML510/1200 doz. ... each 1/6

MIDLAND CYCLE OIL
 Supplied in 1 gall. tins.
 ML512/Trade ... each 9/-

MIDLAND UPPER CYLINDER LUBRICANT
 ML513/Trade Quart tins ... each 2/6

W. G. CHEESE LIMITED
 CYCLE AND MOTOR ACCESSORIES, WIRELESS AND ELECTRICAL SUNDRIES

JUPITER HOUSE
 326-327, BRADFORD ST., BIRMINGHAM, 5
 Telephone: MIDland 5804/5 (2 lines)



**3-IN-1
STOP RUST
CHROME
CLEANER**
MP10/2603 dozen
each 3/-



**FINA
HUMBROL TUBES OF GREASE**
ML535/1200 doz. "Excolene" ... each 1/6
1000 1/3

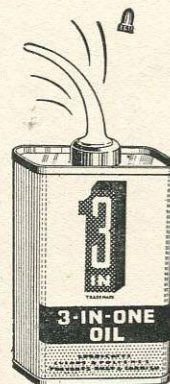

3-IN-1 OIL
Flexi-cans.
ML538/1103 doz.
each 1/3

8-oz. Spout-can.
ML539/2401 doz.
each 2/9

**SIMONIZ
CHROME CLEANER**

Keep all chrome sparkling bright with Simoniz Chrome Cleaner.

MP12/2500 doz.
per tin 2/9



**AUTOBRITE
SILICONE
PROCESS POLISH**

MP21/2401 doz.
Bottles ... each 2/9
MP22/4309 doz.
Bottles ... each 5/-



KARPOL
C.F. Quality. For cellulose finishes. Blue tin.
MP26/2700 doz.
"A" size Tin each 3/-
MP27/900
1/2-gall. Tin ... each 11/6
MP28/1600
1-gall. Tin ... each 20/-



JOHNSON'S ONE-STEP POLISH
Instant One-Step in pressurised tin.
MP37/905 ... each 12/6



**SIMONIZ
BODYSHEEN**

Simoniz Bodysheen has got its own built-in cleaner; it cleans and polishes in one fast, easy operation.

MP14/309 per tin 5/-

N.F. Quality. For new finishes. Red tin.
MP29/4309 doz. "A" size Tin each 5/-
MP30/1600 1/2-gall. Tin ... each 22/-
MP31/3000 1-gall. Tin ... each 40/-

JOHNSON'S ONE-STEP POLISH
MP38/401 1/2 Trial Size ... each 5/6
MP39/706 Economy Size ... each 10/-



SIMONIZ SPEEDWAX

Specially made for today's gay colours. Gives your car hard wax shine and protection.

MP13/706 ... per tin 10/-



**I.C.I.
LIQUID
POLISH
No. 7**

General - purpose polish for giving showroom appearance.

MP33/202
16-oz. Tin
per tin 3/3



JOHNSON'S CAR PLATE CLEANER
MP41/207 1/2 10-oz. Tins ... each 3/6

JOHNSON'S CAR PLATE
MP42/309 10-oz. Tins ... each 5/-



SIMONIZ WAX

MP18/303 7-oz. Tins ... per tin 7/-

SIMONIZ PASTE KLEENER

To be used before applying Simoniz Polish.
MP19/305 ... per tin 5/-

SIMONIZ LIQUID KLEENER

MP20/309 ... per tin 5/-



FLEXY CAR WASHER

No. 950. A constant stream of water passes through the brush. Fitted high-pressure nozzle for wheels, chassis, and flexible rubber back.

MP35/2908 ... each 39/6



JOHNSON'S CHROME CLEANER
MP44/101 1/2 5-oz. Tins ... each 1/6

JOHNSON'S DEEP GLOSS CARNU
MP45/309 10-oz. Tins ... each 5/-



DURAGLIT METAL POLISH

MP76/1202 doz. Small Size ... each 1/4

DURAGLIT SILVER POLISH

MP77/1406 doz. Small Size ... each 1/7



CROWN CHROME CLEANER

MP86/2400 doz. ... each 3/-

AUTOCHROME

/1000 doz. ... each 1/3



KARWAD CAR POLISH

Wadding impregnated with polish, no spills, no mess. A showroom finish in minutes.
MP98/5206 doz. ... each 6/-



GRE-SOLVENT PASTE

No. G1. Size 2. 1-lb. Tins.
MP100/1006 ... per doz. 14/-
No. G2. Size 3. 2-lb. Tins.
MP101/1800 ... per doz. 24/-
No. G3. Size 4. 7-lb. Tins.
MP102/411 ... per doz. 6/6
No. G4. Size 5. 28-lb. Tins.
MP103/1606 ... each 22/-
No. G5. 56-lb. Kegs.
MP104/2700 ... each 36/-
No. G6. 112-lb. Kegs.
MP105/4703 ... each 63/-



WINDOLENE
MP78/1309 doz. per bottle 1/6



SPONTEX CAR SPONGES

Standard rectangular, 5 1/2" x 4 1/2" x 1 3/8".
MP89/206 ... each 3/9
Plus Purchase Tax 7 1/2 d.
No. C/2. Extra large, 5 1/2" x 4 1/2" x 2".
MP90/307 ... each 5/5
Plus Purchase Tax 11d.



LIFEGUARD LIQUID POLISH

Gives a brilliant clean lustre which will not rain-spot or fingermark.
MP88/206 14-oz. Tins each 3/9



HOLT'S WINDO-GLO
MP79/3505 doz. per tin 3/11

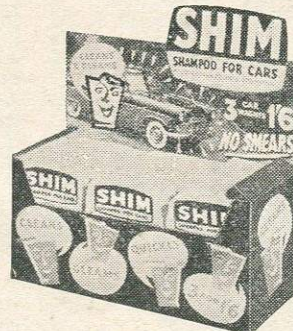

SHIM SHAMPOO FOR CARS

Supplied in cartons of 3 dozen Clips. 3 sachets per clip.
MP92/1306 doz. clips ... per clip 1/6



GUNK D.P. SOLUTION

MP106/2100 doz. Pint ... each 2/4
MP107/3600 doz. Quarts ... each 4/-
MP108/9600 doz. 1 Gallon ... each 10/8



HOLT'S WONDARCHROME

MP81/009 Small size each 1/-



JENOLITE RUST REMOVER

3-oz. Polythene Bottles.
MP84/1600 doz. each 2/-



BOSTIK CLEAR ADHESIVE

Sticks plastics, metal, leather, felt, glass, wood, etc. together and any one to each other.
MP96/1400 doz. ... per tube 1/9



SWARFEGA JELLY HAND CLEANER

MP110/1200 doz. Tubes ... each 1/4
MP111/1306 9-oz. Tins per doz. 18/-
MP112/306 2 1/2-lb. Tins ... each 4/8
MP113/1206 1-gall. Can ... each 16/6
MP114/Trade 28-lb. Kegs ... each 30/4
MP115/Trade 56-lb. Kegs ... each 56/-

Y O S

W. G. CHEESE LIMITED
CYCLE AND MOTOR ACCESSORIES, WIRELESS AND ELECTRICAL SUNDRIES

JUPITER HOUSE
326-327, BRADFORD ST., BIRMINGHAM, 5
Telephone: MIDland 5804/5 (2 lines)

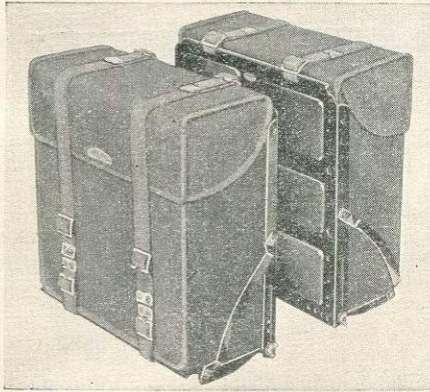

MIDLAND DE-LUXE PANNIER SETS

No. 4769. Two bags 12" x 13" x 10½" to 6½". Made from heavy quality Black or Grey canvas. All seams waterproof.
 MP144/5804 ... per pair 87/2
 Plus Purchase Tax 14/-

FRAMES AND FITTINGS COLOURED
 MP145/4400 ... Extra ... 66/-

MIDLAND STANDARD PANNIER SETS

No. 4781. Two bags 13" x 13" x 6". Made from heavy quality Black or Grey canvas. All seams waterproof.
 MP146/4402 ... per pair 66/2
 Plus Purchase Tax 10/7

FRAMES AND FITTINGS COLOURED
 MP148/4400 ... Extra ... 66/-

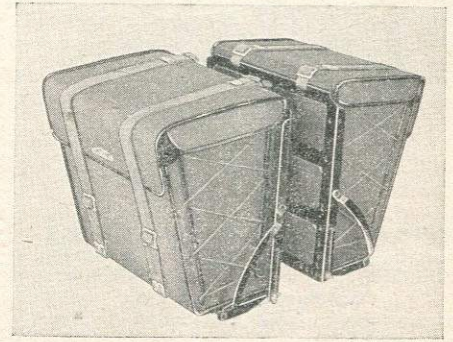

MIDLAND MOTOR CYCLE TOURING PANNIER SETS

Models specifically designed for the following makes of motor cycle

TYPE	YEAR	MODEL No.		TYPE	YEAR	MODEL No.	
		Standard	De Luxe			Standard	De Luxe
A.J.S.							
14 248 c.c.	(SF)	1959	4781/7216	4769/7216			
16 MS. 347 c.c.	(SF)	1957/8	4781/6150	4769/6150			
16 347 c.c.	(SF)	1959	4781/7213	4769/7213			
18 S., 498 c.c.	(SF)	1957/8	4781/6150	4769/6150			
18, 498 c.c.	(SF)	1959	4781/7213	4769/7213			
20, 498 c.c. Twin	(SF)	1959	4781/7213	4769/7213			
31 646 c.c. Twin	(SF)	1959	4781/7213	4769/7213			
AMBASSADOR							
Popular, 147 c.c.	(SF)	1956/8	4781/6139	4769/6139			
Popular, 173 c.c.	(SF)	1959	4781/7223	4769/7223			
Popular, 197 c.c.	(R)	1951/5	4781/6028	4769/6028			
Envoy, 197 c.c.	(SF)	1959	4781/7222	4769/7222			
Supreme, 250 c.c.	(SF)	1957/8	4781/6159	4769/6159			
ARIEL							
N.H., 347 c.c. Hunter Single	(SF)	1959	4781/7203	4769/7203			
V.H., 497 c.c. Hunter Single	(SF)	1959	4781/7203	4769/7203			
F.H., 646 c.c. Huntmaster Twin	(SF)	1959	4781/7203	4769/7203			
B.S.A.							
D.1, 123 c.c. Bantam	(P)	1956/9	4781/6122	4769/6122			
D.3, 148 c.c. Bantam Major	(P)	1956/8	4781/6120	4769/6120			
D.7, 174 c.c. Bantam Super	(SF)	1959	4781/7204	4769/7204			
C.15, 249 c.c. 250 Star	(SF)	1959	4781/7206	4769/7206			
B.31, 348 c.c.	(SF)	1959	4781/7205	4769/7205			
B.33, 499 c.c.	(SF)	1959	4781/7205	4769/7205			
A.7, 497 c.c. Twin	(SF)	1959	4781/7205	4769/7205			
A.10, 646 c.c. Golden Flash Twin	(SF)	1959	4781/7205	4769/7205			
A.10, 646 c.c. Road Rocket Twin	(SF)	1959	4781/7205	4769/7205			
EXCELSIOR							
57/F.6S, 98 c.c. Consort	(P)	1957/8	4781/6148	4769/6148			
C.3, 148 c.c. Courier	(SF)	1956	4781/6118	4769/6118			
R.6, 197 c.c. Roadmaster	(SF)	1956	4781/6118	4769/6118			
57/TT.3, 244 c.c. Talisman Twin	(SF)	1957	4781/6155	4769/6115			
STT.6, 244 c.c. Sports Tal. Twin	(SF)	1958	4781/6156	4769/6156			
59/TT.4, 244 c.c. Talisman Twin	(SF)	1959	4781/7220	4769/7220			
FRANCIS-BARNETT							
79, 171 c.c. Light Cruiser	(SF)	1959	4781/7210	4769/7210			
81, 197 c.c. Falcon	(SF)	1959	4781/7209	4769/7209			
80, 249 c.c. Cruiser	(SF)	1959	4781/7210	4769/7210			
JAMES							
L.1, 98 c.c. Comet 100	(SF)	1956/8	4781/6128	4769/6128			
L.15, 147 c.c. Cadet 150	(SF)	1956/8	4781/6128	4769-6128			
K.7, 197 c.c. Captain	(SF)	1959	4781/7219	4769/7219			
MATCHLESS							
G.2, 248 c.c.	(SF)	1959	4781/7216	4769/7216			
G.3, 347 c.c.	(SF)	1959	4781/7213	4769/7213			
G.80, 498 c.c.	(SF)	1959	4781/7213	4769/7213			
G.11, 592 c.c. Twin	(SF)	1957/8	4781/6150	4769/6150			
G.12, 646 c.c. Twin	(SF)	1959	4781/7213	4769/7213			
NORMAN							
B.1S, 147 c.c.	(SF)	1959	4781/7224	4769/7224			
B.2S, 197 c.c. Roadster	(SF)	1959	4781/7224	4769/7224			
B.3, 250 c.c. Roadster	(SF)	1959	4781/7224	4769/7224			
NORTON							
50, 348 c.c.	(SF)	1959	4781/7215	4769/7215			
ES.2, 490 c.c.	(SF)	1959	4781/7215	4769/7215			
88, 497 c.c. Twin	(SF)	1959	4781/7215	4769/7215			
597 c.c. Twin	(SF)	1959	4781/7215	4769/7215			
19s, 596 c.c.	(SF)	1956/8	4781/6130	4769/6130			
PANTHER							
10/4, 197 c.c.	(SF)	1957/8	4781/6154	4769/6154			
25, 246 c.c.	(SF)	1957/8	4781/6154	4769/6154			
65, 248 c.c.	(SF)	1956	4781/6127	4769/6127			
75, 348 c.c.	(SF)	1956	4781/6127	4769/6127			
100, 598 c.c. Redwing	(SF)	1956/8	4781/6125	4769/6125			
100, 598 c.c. Standard	(SF)	1959	4781/7217	4769/7217			
120, 649 c.c. De Luxe	(SF)	1959	4781/7217	4769/7217			
ROYAL ENFIELD							
250 Crusader, 248 c.c.	(SF)	1959	4781/7200	4769/7200			
350 Clipper, 346 c.c.	(SF)	1959	4781/7201	4769/7201			
350 Bullet, 346 c.c.	(SF)	1959	4781/7201	4769/7201			
500 Bullet, 499 c.c.	(SF)	1959	4781/7201	4769/7201			
Constellation 692 c.c.	(SF)	1959	4781/7201	4769/7201			
SUN							
98 c.c. Hornet 3	(R)	1954/8	4781/6090	4769/6090			
147 c.c. Challenger	(SF)	1956/7	4781/6143	4769/6143			
Mk. V, Challenger	(SF)	1956/7	4781/6143	4769/6143			
197 c.c. Wasp	(SF)	1956/8	4781/6141	4769/6141			
249 c.c. Overlander Twin	(SF)	1957/8	4781/6162	4769/6162			
SUNBEAM							
S.7, 487 c.c. Twin	(P)	1951/6	4781/6019	4769/6019			
S.8, 487 c.c. Twin	(P)	1954/6	4781/6078	4769/6078			
TRIUMPH							
T20, 199 c.c. Tiger Cub	(SF)	1959	4781/7211	4769/7211			
3TA, 348 c.c. Twenty-One	(SF)	1957/9	4781/6171	4769/6171			
5TA, 498 c.c. Speed Twin	(SF)	1959	4781/6171	4769/6171			
T100, 498 c.c. Tiger 100	(SF)	1959	4781/7212	4769/7212			
T110, 649 c.c. Tiger 110	(SF)	1959	4781/7212	4769/7212			
6T, 649 c.c. Thunderbird Twin	(SF)	1959	4781/7212	4769/7212			
VELOCETTE							
LE, 192 c.c. Twin	(SF)	1952/9	4781/6048	4769/6048			
192 c.c. Valiant Twin	(SF)	1959	4781/7202	4769/7202			
349 c.c. MAC	(SF)	1959	4781/7214	4769/7214			
349 c.c. Viper	(SF)	1959	4781/7214	4769/7214			
499 c.c. MSS	(SF)	1959	4781/7214	4769/7214			
499 c.c. Venom	(SF)	1959	4781/7214	4769/7214			

R.—Rigid Frame.

S.F.—Swinging Fork Suspension.

P.—Plunger Spring Frame.

S.H.—Spring Hub Suspension.

M 67

W. G. CHEESE LIMITED
 CYCLE AND MOTOR ACCESSORIES, WIRELESS
 AND ELECTRICAL SUNDRIES

JUPITER HOUSE
 326-327, BRADFORD ST., BIRMINGHAM, 5
 Telephone: MIDland 5804/5 (2 lines)

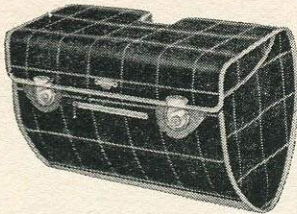

BROOKS LIMPET SCOOTER BAGS
 No. 3. Supplied in Grey, double texture rayon.
 MP162/3108 each 47/6
 Plus Purchase Tax 7/6
 No. 3. Also supplied in Gordon or Royal Stewart tartan.
 MP163/3403 each 51/4
 Plus Purchase Tax 8/3



LYCETT TRIPLE SUITE

Something really new in Scooter luggage. Double texture rayon in Grey, Gordon tartan and Royal Stewart tartan. Comprises three pieces of really smart styled and matched luggage. Case (18" x 12" x 6") well proportioned and excellently finished. Panniers (15" x 13" x 5 3/4") instantly attached and detached for use as personal luggage. First quality weather resistant materials with high-grade locks. Pannier lid styling and internal wire support provides full accessibility. Cleverly contrived and patented carrier brackets give complete and invisible support to side panniers...no straps or clips. Dispenses with the need for untidy or unsafe luggage. A must for the scooter tourist.

Suite complete.
 MP176/8900 complete 133/7
 Plus Purchase Tax 18/11

Case only.
 MP177/3008 each 46/-
 Plus Purchase Tax 7/6

Side Panniers, single, including brackets.
 MP178/3008 each 45/10
 Plus Purchase Tax 6/2

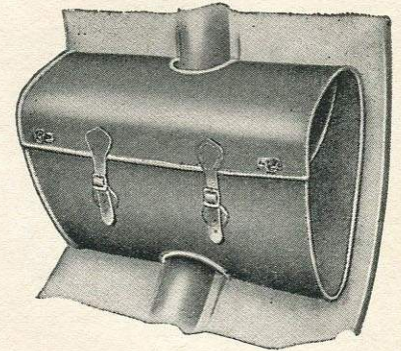

"RADSPORT" SCOOTER BAGS
 Made from double texture waterproof material. Size 17 1/2" x 12 1/2" x 9", fitted with a pair of chrome lock holders and leather straps. The interior metal girders are sturdy and control the fixing bolts and side stiffeners.
 No. 616. Royal Stuart (Red).
 No. 617. Squirrel Grey (Grey).
 No. 619. Royal Gordon (Blue).
 MP186/2200 each 33/-
 Plus Purchase Tax 5/3



"RADSPORT" MOPED PANNIER BAGS
 No. 118/9. Available in Red Stuart Tartan or Grey.
 R51/2200 per pair 33/-
 Plus Purchase Tax 5/3

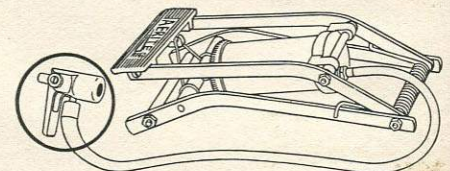

"AERITE" FOOT PUMPS
 No. 244. Complete with snap-on connector. Polished brass cylinder.
 MP190/1500 each 20/-

BLUEMEL'S "MOTOBIKE" MOTOR CYCLE INFLATORS

Metal barrel, celluloid covered.
 Ref. Nominal
 No. Size To fit pump pegs
 1619 12" x 7/8" 12" to 12 3/4" apart
 1611 13" x 7/8" 13" to 13 3/4" apart
 1612 14" x 7/8" 14" to 14 3/4" apart
 1030 15" x 7/8" 15" to 15 3/4" apart
 1618 16" x 7/8" 16" to 16 3/4" apart

MP180/504 each 8/-



"THAPEX" MOTOR CYCLE INFLATORS

Steel lined, black celluloid covered with wire stirrup and fitted with 12" swivel ended connections. 12", 14", 15" or 16" x 7/8".
 MP194/406 each 6/9
 MP.195/500. As above. 18" each 7/6

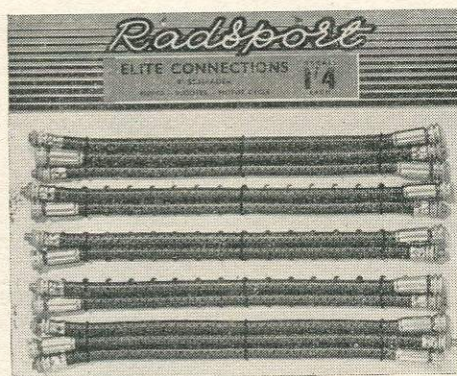

RADSPORT MOPED/SCOOTER PUMP CONNECTIONS

9" long to fit Schrader. Finest possible value. Card of 12.
 MP171/908 (card) each 1/4

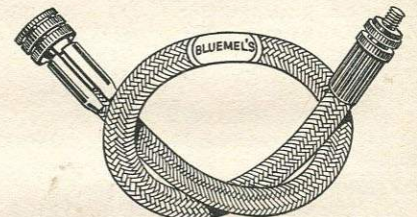

BLUEMEL'S "MOTOBIKE" PUMP CONNECTIONS

No. 14. 15" long, fitted with swivel end for Schrader and adaptor for Dunlop valves.
 MP192/1408 doz. each 1/10



DUNLOP MOTOR CYCLE PUMPS
 MCP/0. 15" x 7/8". Celluloid, Metal Lined.
 MP172/500 each 7/6
 MCP/1. 16" x 7/8". Celluloid, Metal Lined.
 MP173/500 each 7/6
 MCP/4. 14" x 7/8". Celluloid, Metal Lined.
 MP174/500 each 7/6

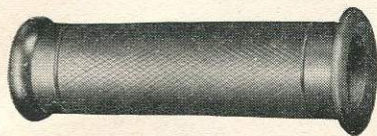

DARE MOTOR CYCLE TWIST AND DUMMY GRIPS

No. TG010. Closed end type. 4 $\frac{3}{8}$ " long. Bore $\frac{7}{8}$ ", 1" or 1 $\frac{1}{8}$ ". Thick wall.
MR50/608 each 10d.

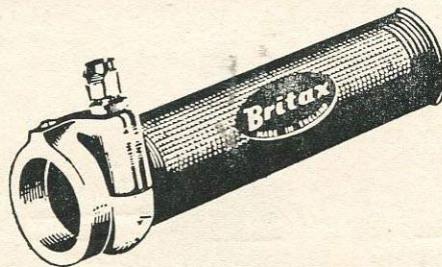

BRITAX JUNIOR TWIST GRIP

Friction type, for motorised cycles. Cable fitting obviates the use of nipple at twist grip end and cable replacement can be effected without dismantling the twist grip. Single screw fitting, polished body and fitted with rubber grip.

No. M351. To fit $\frac{7}{8}$ " handlebars only.
MR59/404 each 6/6

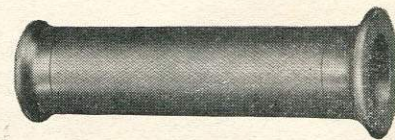

DARE MOTOR CYCLE TWIST AND DUMMY GRIPS

No. TG020. Closed end type. 4 $\frac{3}{8}$ " long. Bore $\frac{7}{8}$ " or 1". Thin wall.
MR54/608 each 10d.



DOHERTY STANDARD TWIST GRIPS

No. 62. Length 7 $\frac{1}{2}$ ". Pull 1 $\frac{5}{8}$ ". For $\frac{7}{8}$ " or 1" handlebars.
MR61/700 each 10/6
No. 71. Length 5 $\frac{5}{8}$ ". Pull 1 $\frac{5}{8}$ ". Dia. $\frac{7}{8}$ " or 1".
MR62/608 each 10/-

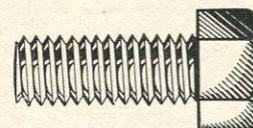

SETSCREWS AND NUTS

C.E.I. Screws and Nuts. Assorted Sizes. $\frac{1}{4}$ " diameter \times $\frac{1}{2}$ " to 2" long.

MS36/204	1"	per doz.	—
MS37/206	1 $\frac{1}{4}$ "	per doz.	—
MS38/206	1 $\frac{1}{2}$ "	per doz.	—
MS39/300	2"	per doz.	—

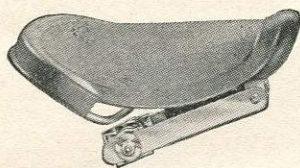

LYCETT MOPED SADDLE

No. L100. Rubber envelope top with large seating area fitted on strong wire frame with cantilever type springing. Standard $\frac{7}{8}$ " clip fitting. Suitable for auto-cycles and mopeds. Size 11 $\frac{1}{2}$ " \times 11 $\frac{1}{4}$ " \times 4 $\frac{1}{2}$ ".
MS20/1608 each 25/-

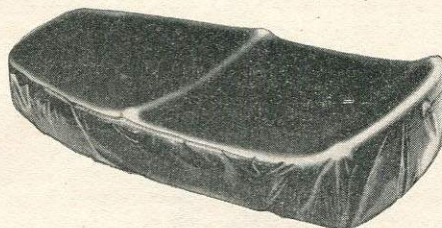

TWIN SEAT COVERS

Black or Red tartan plastic.
MS25/402 each 6/3
Leopard Skin.
MS26/402 each 6/3

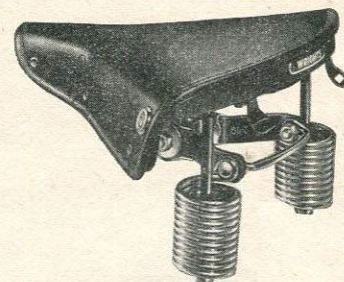

WRIGHT POWER-CYCLE SADDLE

No. S65/3. Sprung Mattress Interior with thick felt underlay. Vynide waterproof seat 10 $\frac{3}{4}$ " \times 11 $\frac{1}{2}$ ".
MS30/1804 each 27/6



M.P.C. "DUALITE" DUAL SEAT

With Dunlopillo interior and Vynide covers. Finished in Black, Maroon, Grey, Blue, Bantam Green and Beige. Complete with handrail.
MS22/6108 each 92/6
Without handrail.
MS23/5608 each 85/-



DUNLOP RUBBER BOOTS

No. 6802. Short knee length, sizes 6-12.
MR56/2306 per pair 31/9
Plus Purchase Tax 1/2
No. 6503. Knee length, sizes 5-12.
MR57/2603 per pair 35/6
Plus Purchase Tax 1/3 $\frac{1}{2}$

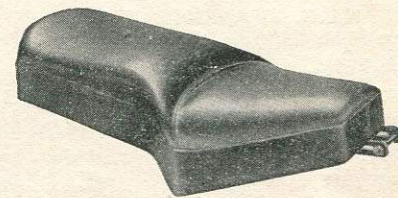

LYCETT DUAL SEAT

A combination of moulded rubber and spring mattress suspension, with a replaceable tailored top.
Model DS1. With rear coil springs.
MS32/7304 each 110/-
Model DS2.
MS33/7000 each 105/-
A rear handrail (chromium plated) is provided as an optional extra.
MS34/304 each 5/-

B 70

W. G. CHEESE LIMITED
CYCLE AND MOTOR ACCESSORIES, WIRELESS
AND ELECTRICAL SUNDRIES

JUPITER HOUSE
326-327, BRADFORD ST., BIRMINGHAM, 5
Telephone: MIDland 5804/5 (2 lines)



K.L.G. SPARKING PLUGS

Type M30.	18 ^m / _m dia. thread,	1/2" reach.
Type M50.	18 ^m / _m dia. thread,	reach.
Type M80.	18 ^m / _m dia. thread,	reach.
Type M100.	18 ^m / _m dia. thread,	reach.
Type ML30.	18 ^m / _m dia. thread,	1/16" reach.
Type ML50.	18 ^m / _m dia. thread,	1/16" reach.
MS125/306	...	each 5/-
MS126/301 1/2	...	3-do. lots
MS127/300	...	6-do. lots
MS128/210 1/2	...	12-do. lots



K.L.G. SPARKING PLUGS

Type F50.	14 ^m / _m dia. thread,	1/2" reach.
Type FE50.	14 ^m / _m dia. thread,	3/4" reach.
MS102/306	...	each 5/-
MS103/301 1/2	...	3-do. lots
MS104/300	...	6-do. lots
MS105/210 1/2	...	12-do. lots



K.L.G. SPARKING PLUGS

Type F70.	14 ^m / _m dia. thread,	1/2" reach.
Type FE70.	14 ^m / _m dia. thread,	3/4" reach.
MS116/306	...	each 5/-
MS117/301 1/2	...	3-do. lots
MS118/300	...	6-do. lots
MS119/210 1/2	...	12-do. lots



K.L.G. SPARKING PLUGS

Type F100.	14 ^m / _m dia. thread,	1/2" reach.
Type FE100.	14 ^m / _m dia. thread,	3/4" reach.
MS92/306	...	each 5/-
MS93/301 1/2	...	3-do. lots
MS94/300	...	6-do. lots
MS95/210 1/2	...	12-do. lots



K.L.G. SPARKING PLUGS

Type M60.	18 ^m / _m dia. thread,	1/2" reach.
Type ML60.	18 ^m / _m dia. thread,	1/16" reach.
MS108/306	...	each 5/-
MS109/301 1/2	...	3-do. lots
MS110/300	...	6-do. lots
MS111/210 1/2	...	12-do. lots



K.L.G. SPARKING PLUGS

Type F80.	14 ^m / _m dia. thread,	1/2" reach.
Type FE80.	14 ^m / _m dia. thread,	3/4" reach.
MS121/306	...	each 5/-
MS122/301 1/2	...	3-do. lots
MS123/300	...	6-do. lots
MS124/210 1/2	...	12-do. lots

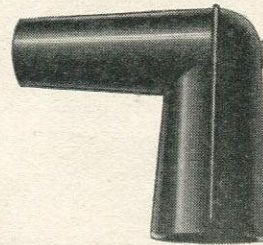

K.L.G. SPARKING PLUGS

Type TEN50.	10 ^m / _m dia. thread,	1/4" reach.
Type TENL30.	10 ^m / _m dia. thread,	1/2" reach.
Type TENL50.	10 ^m / _m dia. thread,	1/2" reach.
Type TENL100.	10 ^m / _m dia. thread,	1/2" reach.
MS97/306	...	each 5/-
MS98/301 1/2	...	3-do. lots
MS99/300	...	6-do. lots
MS100/210 1/2	...	12-do. lots

K.L.G. SUPPRESSOR COVERS

Type "PS".	The waterproof cover with built-in ignition suppressor. (15000 ohms.)
MS113/203	... each 3/-
Type "SS".	(Straight) waterproof cover with built-in suppressors. (15000 ohms.)
MS114/300	... each 4/-

K.L.G. SPARKING PLUGS

Type F20.	14 ^m / _m dia. thread,	1/2" reach.
Type FE20.	14 ^m / _m dia. thread,	3/4" reach.
MS87/306	...	each 5/-
MS88/301 1/2	...	3-do. lots
MS89/300	...	6-do. lots
MS90/210 1/2	...	12-do. lots

C 274

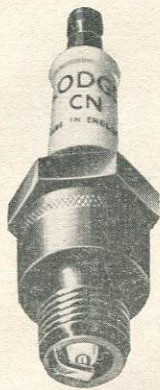

CN. 14 mm.



CNY. 14 mm.



HLN. 14 mm.

LODGE SPARKING PLUGS

Type	Thread Dia.	Reach	Detachable	Type	Thread Dia.	Reach	Non-Detachable
C14	14 ^m / _m	1 1/2"	MS142/306 ... each 5/- MS143/304 ... 3-do. lots MS144/302 ... 6-do. lots MS145/300 ... 12-do. lots	CN	14 ^m / _m	1 1/2" 1 1/4" 1 1/2" 3/4" & 3/8" 1 1/2" 1 1/4"	MS166/306 ... each 5/-
H14	14 ^m / _m	1 1/2"		HN	14 ^m / _m		MS147/304 ... 3-do. lots
BN	14 ^m / _m	1 1/2"		CLN	14 ^m / _m		MS148/302 ... 6-do. lots
BLN	14 ^m / _m	1 1/2"		HLN	14 ^m / _m		MS169/300 ... 12-do. lots
C3	18 ^m / _m	1 1/2"		C10	10 ^m / _m		MS170/404 ... each 6/6 MS171/311 ... 3-do. lots MS172/309 ... 6-do. lots MS173/307 ... 12-do. lots
H1	18 ^m / _m	1 1/2"	CL10	10 ^m / _m	3HN	14 ^m / _m	
H3	18 ^m / _m	1 1/2"		3HLN	14 ^m / _m		
CB3	18 ^m / _m	1 1/2"					
CVL	18 ^m / _m	1 1/2"					
HH14	14 ^m / _m	1 1/2"	MS146/404 ... each 6/6 MS147/311 ... 3-do. lots MS148/309 ... 6-do. lots MS149/307 ... 12-do. lots				

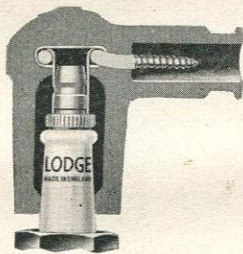

LODGE TERMINAL COVERS

- No. R90. Rubber waterproof cover, angle type, to fit 14^m/_m and 18^m/_m plugs. MS150/204 ... each 3/6
- No. R180. Rubber waterproof cover, straight type, to fit 14^m/_m and 18^m/_m plugs. MS151/204 ... each 3/6
- No. M90X. Insulated shockproof ignition suppressor cover, angle type, to fit 14^m/_m and 18^m/_m plugs. MS152/108 ... each 2/6
- No. M90. Insulated shockproof cover, angle type, to fit 14^m/_m and 18^m/_m plugs. MS153/100 ... each 1/6
- No. M180. Insulated shockproof cover, straight type, to fit 14^m/_m and smaller plugs. MS154/100 ... each 1/6

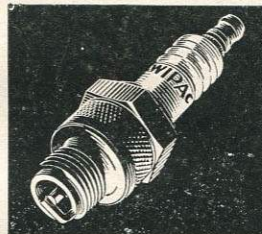

WIPAC SPARKING PLUGS

All types. MS156/206 ... each 3/6



LODGE PLATINUM-POINTED PLUGS

The features of these plugs are:—
 (1) The flexibility of their operating range.
 (2) They have an exceedingly long life—from three to five times that of plugs with normal nickel electrodes.

Type	Thread	Reach
CL10P	10 ^m / _m	1 1/2"
HL10P	10 ^m / _m	1 1/2"
CNP	14 ^m / _m	1 1/2"
HNP	14 ^m / _m	1 1/2"
CLNP	14 ^m / _m	1 1/2"
HLNP	14 ^m / _m	1 1/2"
HN18P	18 ^m / _m	1 1/2"
HLN18P	18 ^m / _m	1 1/2"
MS179/1103		each 15/-

C 104

W. G. CHEESE LIMITED
 CYCLE AND MOTOR ACCESSORIES, WIRELESS
 AND ELECTRICAL SUNDRIES

JUPITER HOUSE
 326-327, BRADFORD ST., BIRMINGHAM, 5
 Telephone: MIDland 5804/5 (2 lines)



CHAMPION TYPE L-8
Thread dia. $14\frac{m}{m}$. Reach $\frac{1}{2}$ ". Terminal A548.
Hexagon $\frac{13}{16}$ ". Gap setting normal .020".



CHAMPION TYPE L-10
Thread dia. $14\frac{m}{m}$. Reach $\frac{1}{2}$ ". Terminal A548.
Hexagon $\frac{13}{16}$ ". Gap setting normal .025".

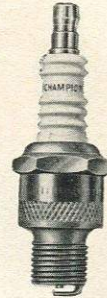

CHAMPION TYPE N8
Thread dia. $14\frac{m}{m}$. Reach $\frac{3}{4}$ ". Terminal A548.
Hexagon $\frac{13}{16}$ ". Gap setting normal .025".



CHAMPION TYPE 7
Thread dia. $18\frac{m}{m}$. Reach $\frac{1}{2}$ ". Terminal A548.
Hexagon 1". Gap setting normal .025".



CHAMPION TYPE L-10S
Thread dia. $14\frac{m}{m}$. Reach $\frac{1}{2}$ ". Terminal A548.
Hexagon $\frac{13}{16}$ ". Gap setting normal .025".



CHAMPION TYPE N5
Thread dia. $14\frac{m}{m}$. Reach $\frac{3}{4}$ ". Terminal A548.
Hexagon $\frac{13}{16}$ ". Gap setting normal .025".



CHAMPION TYPE 8 Com.
Thread dia. $18\frac{m}{m}$. Reach $\frac{1}{2}$ ". Terminal A146.
Hexagon 1". Gap setting normal .020".

CHAMPION TYPE L-11S

Thread dia. $14\frac{m}{m}$. Reach $\frac{1}{2}$ ". Terminal A548.
Hexagon $\frac{13}{16}$ ". Gap setting normal .020".

CHAMPION STANDARD SPARKING PLUG PRICES

MS230/306	Lots of 1-49	...	each	5/-
MS231/303	Lots of 50-149	...	each	/-/-
MS232/300	Lots of 150 and over		each	/-/-



CHAMPION TYPE N3
Thread dia. $14\frac{m}{m}$. Reach $\frac{3}{4}$ ". Terminal A548.
Hexagon $\frac{13}{16}$ ". Gap setting normal .020".

CHAMPION TYPE 7 Com.-L
Thread dia. $18\frac{m}{m}$. Reach $\frac{3}{8}$ ". Terminal AB146.
Hexagon 1". Gap setting normal .025".

CHAMPION TYPE 16

Thread dia. $18\frac{m}{m}$. Reach $\frac{1}{2}$ ". Terminal A146.
Hexagon $\frac{7}{8}$ ". Gap setting normal .025".

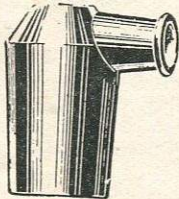

WC548 WCX548
CHAMPION WATERPROOF COVER
Model WC548. Gives complete plug protection by shielding entire insulator. Fits over A548 post terminal.
MS227/100 ... each 1/6
Model WCX548. With suppressor inserts.
MS228/108 ... each 2/6



CHAMPION SUPPRESSOR PLUGS

$14\frac{m}{m}$. Types XL10, XN8 and XJ8.
 $18\frac{m}{m}$. Type X7.

MS235/402½	Lots of 1-49	...	each	6/-
MS236/311	Lots of 50-149	...	each	6/-
MS237/307	Lots of 150 and over		each	6/-



CHAMPION PLUGOMETER
MS240/206 ... each 3/6

J 101

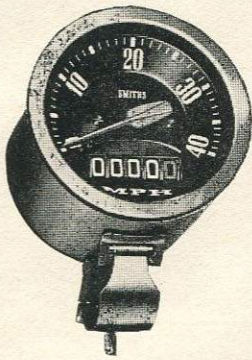

SMITHS DE LUXE SPEEDOMETER

Designed for use on motor-assisted cycles. Has a sturdy magnetic movement specially designed to withstand high frequency vibration associated with motorised cycles.

Gives steady readings from 0-40 m.p.h., and records distances in 1/10ths of a mile up to 9,999. Instrument head has polychromatic grey finish with chromium bezel and black dial with white easy-to-read figures and red pointer.

MS280/4103 complete 55/-

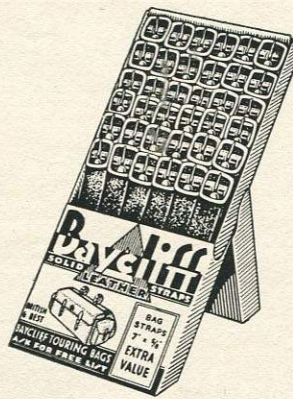

BAYCLIFF LEATHER STRAPS

Made from good quality hide.
 Hanging. Black, 7" x 5/8". 36 per carton.
MS290/1000 per carton 15/-
 Hanging. Natural 7" x 5/8". 36 per carton.
MS291/1400 per carton 21/-
 Hanging. Black 9" x 5/8". 24 per carton.
MS292/904 per carton 14/-
 Hanging. Blue Chrome. 9" x 5/8". 24 per carton.
MS293/1000 per carton 15/-

"RADSPORT" ELASTIC STRAPS

Superior quality. 18" long. Card of 12.
MS301/1304 doz. each 1/8
 12" long. Carded in dozens.
MS302/904 doz. each 1/2

PETROLEUM JELLY

5-oz. Tin.
MS298/0000 doz... each 1/9

CURACHO RUBBING LINIMENT

3-oz. Bottles.
MS299/1806 doz... each 2/6
 Plus Purchase Tax 4/6 Doz.

BLUECOL ANTI-FREEZE

1 Pint Tins (in cases of 24).
MS282/411 Under 24 galls. each 6/6
MS283/407 24 galls. and over each 6/6
 1 Quart Tins (in cases of 12).
MS284/907 Under 24 galls. each 12/9
MS285/811 24 galls. and over each 12/9
 1 Gallon Tins (in cases of 6).
MS286/3702 Under 24 galls. each 49/6
MS287/3408 24 galls. and over each 49/6
 5 Gallon Drums (non-returnable).
MS288/18508 Under 24 galls. each 247/6
MS289/16500 24 galls. and over each 247/6

All the above quantities to be taken in one delivery to qualify for the terms stated.



HURET SPEEDOMETER

Supplied complete in a carton, containing triangular speedo head, 0-40 m.p.h., transmission cable, 26" long, left and right-hand driving gear.

No. MT23". For Phillips "Panda" Mobylette super de luxe and other 23" wheel mopeds.
 /2700 each 36/-

No. MT24". For Mobylette de luxe Junior cycles, 24" wheel.
 /2700 each 36/-

No. MT26". For all 26" wheels.
 /2700 each 36/-

No. MT28". Sports models, 27", 28" wheels.
 /2700 each 36/-

No. MTR. For Raleigh moped.
 /2700 each 36/-

No. AV/NT. Auto Vap.
 /2700 each 36/-

No. T/23D. Hercules.
 /2700 each 36/-

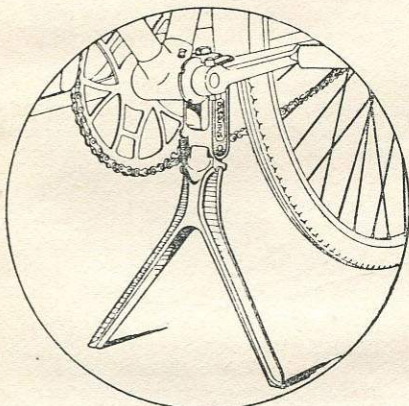

SHURESTA "V" CYCLE STAND

Suitable for motorised cycles. Fits all makes of cycles from 26" to 28" wheels.

MS281/706 each 11/3

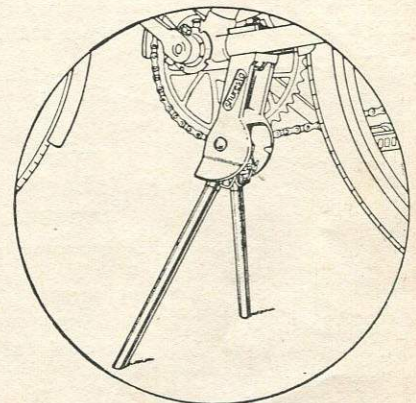

SHURESTA XL CYCLE STAND

Suitable for motorised cycles. Fits all makes of cycles from 26" to 28" wheels. The unique folding action retracts the legs neatly along the chain stays.

MS310/1004 each 15/6



W. G. CHEESE LIMITED
 CYCLE AND MOTOR ACCESSORIES, WIRELESS
 AND ELECTRICAL SUNDRIES

JUPITER HOUSE
 326-327, BRADFORD ST., BIRMINGHAM, 5
 Telephone: MIDland 5804/5 (2 lines)

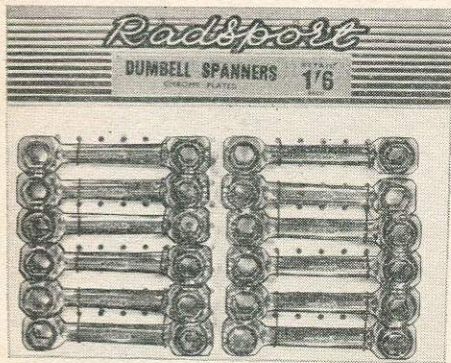

"RADSPORT" DUMBELL SPANNERS

12 per card.
MT92/1200 each 1/6

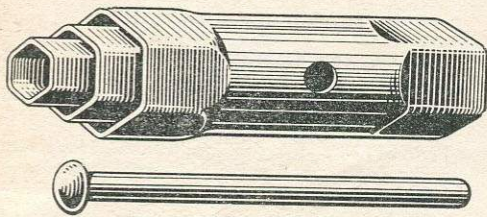

HI-TEN TUBULAR BOX SPANNERS

$\frac{1}{8}'' \times \frac{3}{16}''$, $\frac{1}{4}'' \times \frac{5}{16}''$ and $\frac{3}{8}'' \times \frac{7}{16}''$ Whit.
MT93/208 per set 3/11

VALENTINE METRIC SPANNERS

MT94/404 per set 6/6

LONGBRO TUBULAR BOX SPANNERS

No. 13. Metric. Set of 4 with tommy bar. Supplied boxed.
MT95/304 per set 5/-

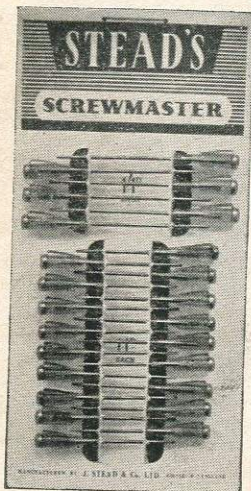

STEAD SCREWDRIVERS

24 assorted on card.
MT98/804 per card
Per card 12/6



STEAD SCREWDRIVERS

No. PH1. Philips pattern. 3" blade.
MT102/210 each 4/3
No. PH2. 4" Blade.
MT103/308 each 5/6

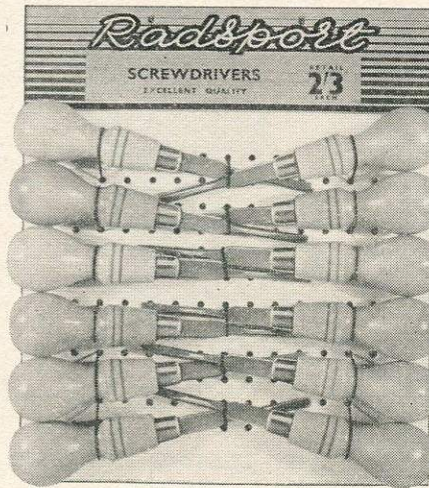

RADSPORT SCREWDRIVERS

12 per card.
MT99/1800 doz. each 2/3

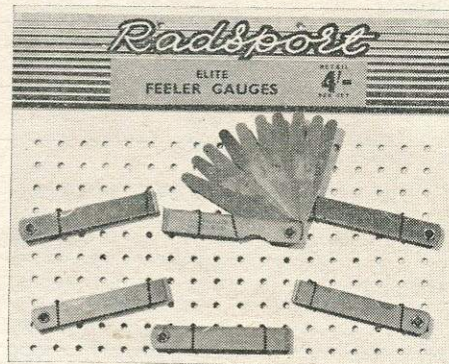

RADSPORT FEELER GAUGES

6 per card.
MT100/1800 card each 4/-

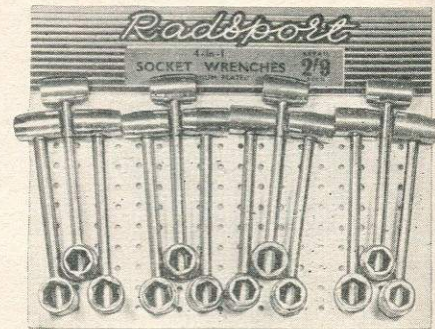

"RADSPORT" 4-in-1 SOCKET WRENCHES

Chromium plated. 12 per card
MT105/2200 each 2/9

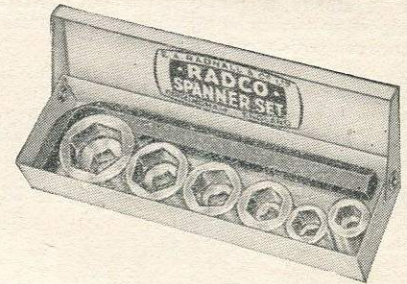

RADNALL SPANNER SETS

Sizes: 4BA, $\frac{3}{8}''$ B.S.F., $\frac{1}{2}''$ W. $\frac{5}{16}''$ B.S.F., $\frac{3}{8}''$ B.S.F. and $\frac{7}{16}''$ B.S.F. Set of 6 socket spanners in metal box. MT106/310 per set 5/9



TERRY "MIDGET" MAGNETO SPANNERS

No. 905. 8-leaved Magneto Spanner Set. Fits all magnetos. Includes .012 Feeler Gauge and small screwdriver. Blued finish.
MT96/104 each 2/-



STEAD ASSORTED SCREWDRIVERS

No. L2. Card of 12.
MT115/400 card each 6d.

W. G. CHEESE LIMITED
CYCLE AND MOTOR ACCESSORIES, WIRELESS
AND ELECTRICAL SUNDRIES

JUPITER HOUSE
326-327, BRADFORD ST., BIRMINGHAM, 5
Telephone: MIDland 5804/5 (2 lines)



DUNLOP DUSTING CHALK

FC/2. Small Flask. 6 per carton.
 MT25/500 doz. ... each 1/-
 FC/3. Tin 12 oz. approx.
 MT26/106 ... each 2/3



DUNLOP "MINOR" KIT

No. RO/5. Consists of 7 Vulcafix patches (assorted sizes), 1 large tube of solution, 1 polythene buffer and 1 metal scrubber.
 MT29/2000 doz. ... each 2/6



DUNLOP "MAJOR" KIT

No. RO/24. Consists of 12 Vulcafix patches (assorted sizes), 1 flask of solution, 1 polythene buffer and 1 metal scrubber.
 MT31/310 ... each 5/9

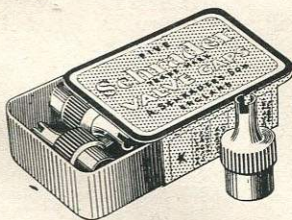

SCHRADER VALVE CAPS

No. 880. Handy tin container holding valve caps for all Schrader valves. In metal boxes of five.
 MT33/2203 per 100 ... per box of five 1/8



ROMAC WORKSHOP CABINETS

No. CC19. Medium size.
 MT35/Trade ... each 42/6
 No. CC20. Large size.
 MT36/Trade ... each 85/-
 No. CC31. Large workshop cabinet and dispenser.
 MT37/Trade ... each 200/-



ROMAC "CURE-C-CURE" MOTOR CYCLIST'S PACK

No. CC25. A display carton of 12.
 MT48/3000 doz. ... each 3/9

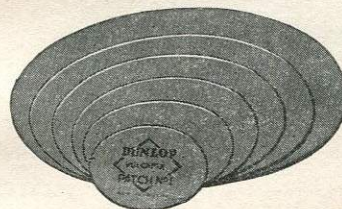

DUNLOP "VULCAFIX" OVAL PATCHES

For solutioned repairs.
 MT40/100 VP/1 1 1/2" x 1 1/4" ... doz. 1/6
 MT41/104 VP/2 2" x 1 1/4" ... doz. 2/-
 MT42/108 VP/3 2 1/4" x 1 1/4" ... doz. 2/6
 MT43/200 VP/4 2 3/4" x 1 1/4" ... doz. 3/-
 MT44/304 VP/5 3 3/8" x 2 1/4" ... doz. 5/-
 MT45/404 VP/6 4 1/2" x 3" ... doz. 6/6



DUNLOP TYRE PRESSURE GAUGE

No. G6. 6-50 lb. in 1-lb. units.
 MT50/508 ... each 8/6



DUNLOP RUBBER SOLUTION

MT56/400 doz. Small tubes each 6d.
 MT57/504 doz. Large tubes each 8d.
 MT58/1000 doz. Small flask ... each 1/3
 MT59/1200 doz. Small tins ... each 1/6
 MT60/2000 doz. Medium tins each 2/6
 MT61/3600 doz. Large tins ... each 4/6



JOHN BULL TYRE REPAIR OUTFIT

No. 2. Contains Vulca-Grip Patches, Rubber Solution, Wire Brush, French Chalk, Valve Parts, etc. Packed in non-rattle tin. Boxed in 1/2-dozens.
 MT64/408 ... each 7/-



JOHN BULL TYRE REPAIR OUTFIT

No. 1. Contains all the necessary equipment for repairing punctures. Each kit is contained in an attractive tin, and the tins are supplied in display carton containing 12 outfits.
 MT66/3600 doz. ... each 4/6

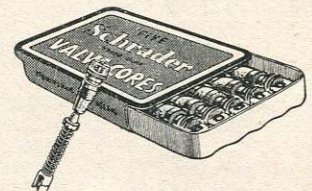

SCHRADER VALVE CORES

No. 4000. The standard interior for all Schrader valves. Five to box.
 MT68/2500 per 100 per box of five 1/10

DUNLOP RUBBER RIM BANDS

No. RB/3. Motor cycle. Size 18" x 18" and 20" x 21".
 MT48/1800 doz. ... each 2/3

N-E-I 110

W. G. CHEESE LIMITED
 CYCLE AND MOTOR ACCESSORIES, WIRELESS
 AND ELECTRICAL SUNDRIES

JUPITER HOUSE
 326-327, BRADFORD ST., BIRMINGHAM, 5
 Telephone: MIDland 5804/5 (2 lines)



AVON MOTOR CYCLE TYRES AND TUBES MT181/Coded

Covers Each		Tubes Each		S.M.	Covers Each		Tubes Each		Covers Each		Tubes Each			
Speed Master														
2-25/21	/3810	£2 8 6	/1200	15/-	2-50/19	/5000	£3 2 6	/1400	17/6	Spartan Scooter				
2-50/19	/5000	£3 2 6	/1400	17/6	2-75/19	/5400	£3 7 6	/1400	17/6	2-50/15	/4610	£2 18 6	/1400	17/6
2-75/19	/5400	£3 7 6	/1400	17/6	3-00/18	/6010	£3 16 0	/1400	17/6	2-50/16	/4702	£2 19 0	/1400	17/6
2-75/21	/5400	£3 7 6	/1405	18/-	3-00/19	/6200	£3 17 6	/1400	17/6	3-25/12	/5200	£3 5 0	/1400	17/6
3-00/18	/6010	£3 16 0	/1400	17/6	3-00/20	/6205	£3 18 0	/1405	18/-	3-50/8	/4302	£2 14 0	/1400	17/6
3-00/19	/6200	£3 17 6	/1400	17/6	3-25/16	/6205	£3 18 0	/1400	17/6	3-50/10	/5200	£3 5 0	/1400	17/6
3-00/20	/6205	£3 18 0	/1405	18/-	3-25/18	/6507	£4 2 0	/1400	17/6	3-50/12	/6005	£3 15 0	/1400	17/6
3-00/21	/6205	£3 18 0	/1405	18/-	3-25/19	/6800	£4 5 0	/1400	17/6	4-00/8	/5410	£3 8 6	/1400	17/6
3-25/16	/6205	£3 18 0	/1400	17/6	3-50/19	/7902	£4 19 0	/1507	19/6	4-00/12	/6707	£4 4 6	/1400	17/6
3-25/18	/6507	£4 2 0	/1400	17/6	4-00/18	/9600	£6 0 0	/1507	19/6	Spartan Scooter Whitewall				
3-25/19	/6800	£4 5 0	/1400	17/6	4-00/19	/9800	£6 2 6	/1507	19/6	3-50/8	/5200	£3 5 0	/1400	17/6
3-50/19	/7902	£4 19 0	/1507	19/6	S.M. Whitewall				4-00/8	/6507	£4 2 0	/1400	17/6	
Speedmaster Whitewall				3-25/16	/7410	£4 13 6	/1400	17/6	H.M. Ribbed					
3-25/16	/7410	£4 13 6	/1400	17/6	Supreme				(For 3-wheelers). 4.P.R.					
New Supreme				3-00/21	/6205	£3 18 0	/1405	18/-	4-00/8 /5410 £3 8 6 /1400 17/6					
2-25/21	/3810	£2 8 6	/1200	15/-	Sidcar Triple Duty				Power-Master					
3-25/20	/6805	£4 5 6	/1405	18/-	3-25/19	/6800	£4 5 0	/1400	17/6	26x2-00 /2205 £1 8 0 /702 9/-				



MICHELIN MOTOR CYCLE TYRES AND TUBES MT183/Coded

Covers Each		Tubes Each		Golden Arrow	Covers Each		Tubes Each		Covers Each		Tubes Each			
Zigzag														
2-50/75/19	/5400	£3 7 6	/1400	17/6	3-00/19	/6200	£3 17 6	/1400	17/6	Motor Scooter				
3-00/19	/6200	£3 17 6	/1400	17/6	3-25/19	/6800	£4 5 0	/1400	17/6	3-50/8	/4302	£2 14 0	/1400	17/6
3-00/20	/6205	£3 18 0	/1405	18/-	3-50/19	/7902	£4 19 0	/1507	19/6	Black				
3-25/19	/6800	£4 5 0	/1400	17/6	4-00/19	/9800	£6 2 6	/1507	19/6	3-50/8	/5102	£3 4 0	/1400	17/6
3-50/19	/7902	£4 19 0	/1507	19/6	Moped				White Walls					
4-00/18	/9600	£6 0 0	/1507	19/6	23x2-00	/2010	£1 6 0	/702	9/-	3-50/10	/5200	£3 5 0	/1400	17/6
					26x2-00	/2205	£1 8 0	/702	9/-	4-00/8	/5410	£3 8 6	/1400	17/6
										4-00/10	/6102	£3 16 6	/1400	17/6



GOODYEAR MOTOR CYCLE TYRES AND TUBES MT185/Coded

Covers Each		Tubes Each		
All Service				
3-25/16	/5811	£3 16 0	/1302	17/-
3-25/18	/6200	£4 0 0	/1302	17/-
2-75/19	/5102	£3 6 0	/1302	17/-
3-00/19	/5806	£3 15 0	/1302	17/-
3-25/19	/6404	£4 3 0	/1302	17/-
3-50/19	/7409	£4 16 6	/1409	19/-
3-00/20	/5811	£3 16 0	/1307	17/6
Rib				
3-25/16	/5811	£3 16 0	/1302	17/-
3-25/18	/6200	£4 0 0	/1302	17/-
3-00/19	/5806	£3 15 6	/1302	17/-
3-25/19	/6404	£4 3 0	/1302	17/-
Grasshopper				
3-25/19	/6404	£4 3 0	/1302	17/-
3-50/19	/7409	£4 16 6	/1409	19/-

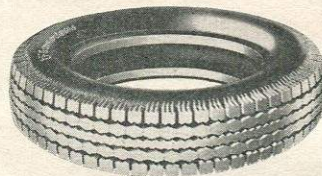

FIRESTONE MOTOR CYCLE TYRES AND TUBES MT187/Coded

All Non-Skid	Covers Each		Tubes Each	
2-75/19	/5400	£3 7 6	/1400	17/6
3-00/19	/6200	£3 17 6	/1400	17/6
3-00/20	/6205	£3 18 0	/1405	18/-
3-25/16	/6205	£3 18 0	/1400	17/6
3-25/17	/6400	£4 0 0	/1400	17/6
3-25/18	/6507	£4 2 0	/1400	17/6
3-25/19	/6800	£4 5 0	/1400	17/6
3-50/19	/7902	£4 19 0	/1507	19/6
4-00/18	/9600	£6 0 0	/1507	19/6
4-00/19	/9800	£6 2 6	/1507	19/6
Club Trial				
3-25/19	/6800	£4 5 0	/1400	17/6
3-50/19	/7902	£4 19 0	/1507	19/6
4-00/19	/9800	£6 2 6	/1507	19/6

MOPED COVERS AND TUBES MT189/Coded

	Covers Each		Tubes Each	
23x2-00	/1909	£1 5 6	/607	8/6
23x2-25	/2202	£1 6 0	/607	8/6
25x2-00	/2006	£1 6 6	/607	8/6
26x2-00	/2104	£1 7 6	/607	8/6

W. G. CHEESE LIMITED
CYCLE AND MOTOR ACCESSORIES, WIRELESS
AND ELECTRICAL SUNDRIES

JUPITER HOUSE
326-327, BRADFORD ST., BIRMINGHAM, 5
Telephone: MIDland 5804/5 (2 lines)

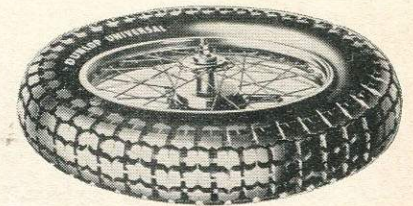
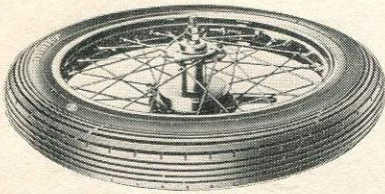

DUNLOP MOTOR CYCLE TYRES MT192/Coded

Wired Tyre Size	Dunlop Universal Cover		Dunlop Ribbed Cover		Dunlop Tube		Wired Tyre Size	Dunlop Trials Universal Cover		Dunlop Sports Cover		Dunlop Tube	
	Trade	Each	Trade	Each	Trade	Each		Trade	Each	Trade	Each	Trade	Each
2.25-19	/4400	£2 15 0	—	—	/1400	17/6	2.75-19	/5400	£3 7 6	/6410	£4 1 0	/1400	17/6
2.50-19	/5000	£3 2 6	/5000	£3 2 6	/1400	17/6	2.75-21	/5400	£3 7 6	/6410	£4 1 0	/1405	18/-
2.75-19	/5400	£3 7 6	/5400	£3 7 6	/1400	17/6	3.00-19	/6200	£3 17 6	/7405	£4 13 0	/1400	17/6
2.75-21	/5400	£3 7 6	—	—	/1405	18/-	3.00-20	/6205	£3 18 0	/7410	£4 13 6	/1405	18/-
3.00-16	/5800	£3 12 6	—	—	/1400	17/6	3.00-21	/6205	£3 18 0	/7410	£4 13 6	/1405	18/-
3.00-18	/6010	£3 16 0	—	—	/1400	17/6	3.25-19	/6800	£4 5 0	/8107	£5 2 0	/1400	17/6
3.00-19	/6200	£3 17 6	/6200	£3 17 6	/1400	17/6	3.50-16	/7210	£4 11 0	/8702	£5 9 0	/1400	17/6
3.00-20	/6205	£3 18 0	/6205	£3 18 0	/1405	18/-	3.50-17	/7405	£4 13 0	—	—	/1400	17/6
3.00-21	/6205	£3 18 0	/6205	£3 18 0	/1405	18/-	3.50-18	/7600	£4 15 0	—	—	/1400	17/6
3.25-16	/6205	£3 18 0	/6205	£3 18 0	/1400	17/6	3.50-19	/7902	£4 19 0	/9502	£5 19 0	/1507	19/6
3.25-17	/6400	£4 0 0	/6400	£4 0 0	/1400	17/6	4.00-18	/9600	£6 0 0	/11502	£7 4 0	/1507	19/6
3.25-18	/6507	£4 2 0	/6507	£4 2 0	/1400	17/6	4.00-19	/9800	£6 2 6	/11707	£7 7 0	/1507	19/6
3.25-19	/6800	£4 5 0	/6800	£4 5 0	/1400	17/6							
3.25-20	/6805	£4 5 6	—	—	/1405	18/-							
3.50-17	/7405	£4 13 0	—	—	/1400	17/6							
3.50-18	/7600	£4 15 0	—	—	/1400	17/6							
3.50-19	/7902	£4 19 0	/7902	£4 19 0	/1507	19/6							
4.00-18	/9600	£6 0 0	—	—	/1507	19/6							
4.00-19	/9800	£6 2 6	—	—	/1507	19/6							
4.50-16	—	—	/9902	£6 4 0	/1902	24/-							
4.75-16	/10805	£6 15 6	—	—	/1902	24/-							

Wired Tyre Size	Dunlop Universal White Sidewall Cover		Dunlop Ribbed White Sidewall Cover		Dunlop Tube		Wired Tyre Size	Dunlop Fort Cover		Dunlop Sidcar Major White Sidewall Cover		Dunlop Sidcar Major Cover	
	Trade	Each	Trade	Each	Trade	Each		Trade	Each	Trade	Each	Trade	Each
3.00-19	/7405	£4 13 0	/7405	£4 13 0	/1400	17/6	3.25-19	/8107	£5 2 0	/8107	£5 2 0	/6800	£4 5 0
3.25-16	/7410	£4 13 6	/7410	£4 13 6	/1400	17/6	3.50-19	/9502	£5 19 0	/9502	£5 19 0	/7902	£4 19 0
3.25-17	/7610	£4 16 0	/7610	£4 16 0	/1400	17/6							
3.25-18	/7810	£4 18 6	/7810	£4 18 6	/1400	17/6							
3.25-19	/8107	£5 2 0	/8107	£5 2 0	/1400	17/6							
3.50-19	/9502	£5 19 0	—	—	/1507	19/6							

Wired Tyre Size	Dunlop Universal White Sidewall Cover		Dunlop Ribbed White Sidewall Cover		Dunlop Tube	
	Trade	Each	Trade	Each	Trade	Each
3.00-19	/7405	£4 13 0	/7405	£4 13 0	/1400	17/6
3.25-16	/7410	£4 13 6	/7410	£4 13 6	/1400	17/6
3.25-17	/7610	£4 16 0	/7610	£4 16 0	/1400	17/6
3.25-18	/7810	£4 18 6	/7810	£4 18 6	/1400	17/6
3.25-19	/8107	£5 2 0	/8107	£5 2 0	/1400	17/6
3.50-19	/9502	£5 19 0	—	—	/1507	19/6

AUTOCYCLE TYRES

Wired Tyre Size	Dunlop White Sidewall Cover		Dunlop Cover		Dunlop Tube	
	Trade	Each	Trade	Each	Trade	Each
2.25-21	—	—	/3810	£2 8 6	/1200	15/-
23 x 2.00	/2410	£1 11 0	/2010	£1 6 0	/702	9/-
23 x 2.25	/2507	£1 12 0	/2102	£1 6 6	/702	9/-
25 x 2.00	/2600	£1 12 6	/2107	£1 7 0	/702	9/-
26 x 2.00	—	—	/2205	£1 8 0	/702	9/-

(for 1755^m/_m Rim)

Beaded Edge Tyre Size	Dunlop Cover		Dunlop Tube	
	Trade	Each	Trade	Each
26 x 2½ x 2¼ ...	/6205	£3 18 0	/1302	16/6
26 x 3 (700 x 80 ^m) ...	/6507	£4 2 0	/1405	18/-
28 x 3 ...	/7010	£4 8 6	/1610	21/-

SCOOTER TYRES

Wired Tyre Size	Dunlop Tubeless Tyre		Dunlop Cover		Dunlop Tube	
	Trade	Each	Trade	Each	Trade	Each
2.50-15	—	—	/4610	£2 18 6	/1400	17/6
3.25-12	/6600	£4 2 6	/5200	£3 5 0	/1400	17/6
3.25-14	—	—	/6010	£3 16 0	/1400	17/6
3.50-7	/5307	£3 7 0	/3907	£2 9 6	/1400	17/6
3.50-8	/5702	£3 11 6	/4302	£2 14 0	/1400	17/6
3.50-10	/6600	£4 2 6	/5200	£3 5 0	/1400	17/6
3.50-12	/7405	£4 13 0	/6005	£3 15 6	/1400	17/6
4.00-8	/6810	£4 6 0	/5410	£3 8 6	/1400	17/6
4.00-10	/7502	£4 14 0	/6102	£3 16 6	/1400	17/6
4.00-12	/8107	£5 2 0	/6707	£4 4 6	/1400	17/6

DUNLOP MOTOR CYCLE RIMS MR196/Coded

Wired Type	Well Base	Unpolished		Wired Type	Well Base	Unpolished		Wired Type	Well Base	Unpolished								
		Each Trade	Each Trade			Each Trade	Each Trade											
2.25-21 } Depressed 'G' Section } and pierced	8/7	W.M.1-18	9/11	W.M.1-19	Depressed and pierced	10/-	10/-	W.M.2-16	10/2	W.M.2-21	Depressed and pierced	10/7						
													W.M.1-20	10/-	W.M.2-17	10/3	W.M.2-22	11/1
													W.M.1-21	10/1	W.M.2-18	10/3	W.M.2-19	10/5
W.M.0-19 } Depressed	9/5	W.M.1-22	10/2	W.M.2-20	10/6	W.M.3-19	11/1	W.M.3-21	11/4	Depressed and pierced	11/4							
W.M.0-21 } and pierced	9/6											W.M.1-23	10/6					

Chromium-plated Finish extra 11/5

When ordering Motor Cycle Rims the following details should be given:—Make of Machine, Model, Year of Manufacture. Engine Capacity. Whether for Front, Rear or Sidcar. Wheel, Rim Size.
This information should be given so that spoke holes can be pierced at correct angle in relation to hub flanges to enable satisfactory wheel to be built.

F 35

W. G. CHEESE LIMITED
CYCLE AND MOTOR ACCESSORIES, WIRELESS
AND ELECTRICAL SUNDRIES

JUPITER HOUSE
326-327, BRADFORD ST., BIRMINGHAM, 5
Telephone: MIDland 5804/5 (2 line.)

112 TYRE LEVERS, VALVE TOOLS & WINDSCREENS



TERRY'S MOTOR CYCLE TYRE LEVERS

No. 71A. Bronzed. Spoon type.
 MT270/800 per doz. 12/-



TERRY'S ONE-MINUTE TYRE LEVERS

No. 735A. Packed in sets of three. Blued steel finish.
 MT272/204 per set 3/6

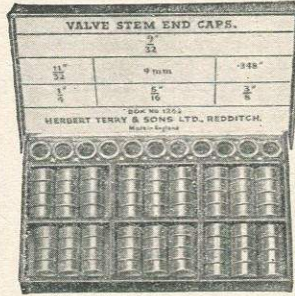

TERRY'S VALVE END CAPS

No. 1262. Box containing 12 each of sizes:
 $\frac{9}{32}$, $\frac{11}{32}$, $9\frac{3}{16}$, 348 , $\frac{1}{4}$, $\frac{5}{16}$, $\frac{3}{8}$.
 MV22/1400 per box 21/-



DUNLOP MOTOR CYCLE TYRE LEVERS

Single-ended. Spoon Type.

MT274/1200 doz. TL/13 7" ... each 1/6
 MT276/2000 doz. TL/2 10" ... each 2/6
 MT278/3000 doz. TL/12 12" ... each 3/9

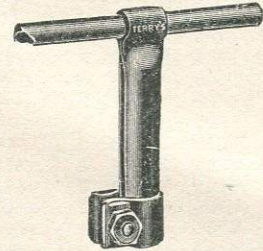

TERRY'S VALVE GRINDING TOOL

No. 1167. For O.H.V. only. Made in two sizes:
 $\frac{3}{8}$ " and $\frac{5}{16}$ ".
 MV24/100 each 1/6

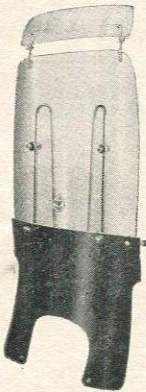

M.P.C. PHOENIX WINDSHIELDS

Ref. B.M.W. Major. Approved by B.S.A. for the Bantam Major D3 motor cycle, also suitable for the N.S.U. Quickly, and all models of the James motor cycles. Perspex $16" \times 14\frac{1}{2}" \times \frac{1}{8}"$ with transparent P.V.C. apron. Complete with visor.
 MW20/3504 each 53/-

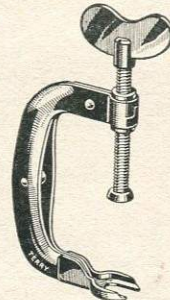

TERRY'S VALVE SPRING COMPRESSOR

No. 1124B

For O.H.V. engines of 250 c.c. and 500 c.c. capacity.
 MV20/1000 each 15/-

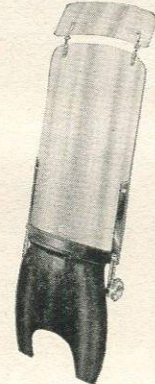

M.P.C. MONSOON WINDSHIELD

Ref. M.S.S. Standard Model. Ideal for lightweights, Bicycles and Autocycles. Perspex $18" \times 12" \times \frac{1}{8}"$ with Black leathercloth apron, complete with visor.
 MW30/3000 each 45/-
 Ref. M.B.S. Bantam Model. Specially designed for the bantam D1 motor cycle. Perspex $18" \times 12" \times \frac{1}{8}"$ complete with Green or Black leathercloth apron.
 MW32/2808 each 43/-

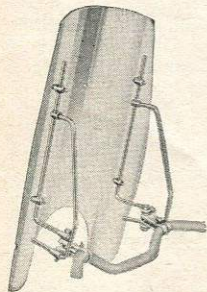

MIDLAND WILBECK MOTOR CYCLE WINDSCREENS

No. 20. Clearvue. Panel measures $24" \times 18"$.
 MW22/5008 each 76/-

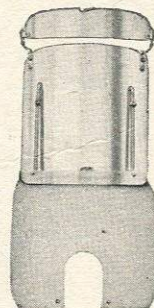

WILBECK MOTOR CYCLE SCREENS

Write for Full List of Types and Prices



MIDLAND WILBECK MOPED WINDSCREENS

No. 85. Suitable for Phillips Gadabout. Panel size: $18" \times 16" \times \frac{1}{8}"$.
 MW34/3400 each 51/-

PANDA WINDSCREENS

MW35/3400 each 51/-

RALEIGH MOPED WINDSCREEN

MW36/3400 each 51/-

AUTOVAP
 3400 D 189 "51/-

W. G. CHEESE LIMITED
 CYCLE AND MOTOR ACCESSORIES, WIRELESS
 AND ELECTRICAL SUNDRIES

JUPITER HOUSE
 326-327, BRADFORD ST., BIRMINGHAM, 5
 Telephone: MIDland 5804/5 (2 lines)

SIDE LINE SECTION

COMPRISING . . .

- **AERIAL WIRE**
- **BULBS**
- **CHAIRS AND TABLES**
- **DARTBOARDS**
- **ELECTRIC BLANKETS**
- **GASLIGHTERS**
- **GLOVES**
- **HAIRDRYERS**
- **HEATERS**
- **IRONS AND KETTLES**
- **LAMPS AND TORCHES**
- **RADIOS**
- **RAZORS**
- **SOCKETS AND PLUGS**
- **SPIN DRYERS**
- **SUCTION CLEANERS**

A 1 17

W. G. CHEESE LIMITED
CYCLE AND MOTOR ACCESSORIES, WIRELESS
AND ELECTRICAL SUNDRIES

JUPITER HOUSE
326-327, BRADFORD ST., BIRMINGHAM, 5
Telephone: MIDland 5804/5 (2 lines)

114 AERIAL WIRE, ELECTRIC BLANKETS & BULBS



AERIALITE AERIAL WIRE Plastic Covered

SL5/1504 doz.	25-ft. coils	...	each 1/11
SL6/2904 doz.	50-ft. coils	...	each 3/8
SL7/4000 doz.	75-ft. coils	...	each 5/-
SL8/5600 doz.	100-ft. coils	...	each 7/-

BULLDOG OR MARKSMAN AIR GUN PELLETS Waisted

No. 1. (.177").			
SL10/304 doz.	Boxes of 100	...	each 5d.
SL11/608 doz.	Boxes of 200	...	each 10d.
SL12/1600 doz.	Boxes of 500	...	each 2/-
No. 2. (.22).			
SL13/2400 doz.	Boxes of 500	...	each 3/-

Prices Plus Purchase Tax

"KING" AIR GUN SLUGS

No. 1. (.177")			
SL14/204 doz.	Boxes of 100	...	each 3½d.
SL15/409 doz.	Boxes of 200	...	each 7d.
SL16/1006 doz.	Boxes of 500	...	each 1/4

Prices Plus Purchase Tax

AIR GUN DARTS

Supplied in packets of one dozen darts.

SL17/102	...	per packet 1/7
----------	-----	----------------

Price Plus Purchase Tax

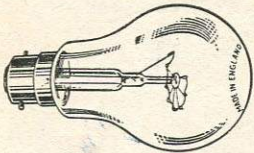

SPLENDOR HOUSE BULBS

British made. Every one guaranteed. Clear or Pearl.

SL45/1008 doz.	15 watt	...	each 1/4
SL46/1008 doz.	25 watt	...	each 1/4
SL47/908 doz.	40 watt	...	each 1/2½
SL48/908 doz.	60 watt	...	each 1/2½
SL49/1104 doz.	75 watt	...	each 1/5
SL50/1104 doz.	100 watt	...	each 1/5
SL51/1504 doz.	150 watt	...	each 1/11

Plus Purchase Tax



PIFCO ELECTRIC BLANKETS

Colours: Pink, Gold and Eau-de-Nil.			
No. 1167. Popular model. Single: 60" × 24".			
SL20/5911	...	each	£3 19 11
Plus Purchase Tax 14/7			
No. 1168. Popular model. Double: 60" × 42".			
SL21/9001	...	each	£6 0 1
Plus Purchase Tax 21/11			
No. 1267. Favourite model. Single: 48" × 26".			
SL22/4107	...	each	£2 15 5
Plus Purchase Tax 10/1			
No. 1268. Favourite model. Double: 48" × 40".			
SL23/5310	...	each	£3 11 10
Plus Purchase Tax 13/2			
No. 2263. De luxe model. Single 62" × 28".			
SL24/10710	...	each	£7 3 9
Plus Purchase Tax 26/3			
No. 2264. De luxe model. Double: 62" × 42".			
SL25/15600	...	each	£10 8 0
Plus Purchase Tax 38/-			

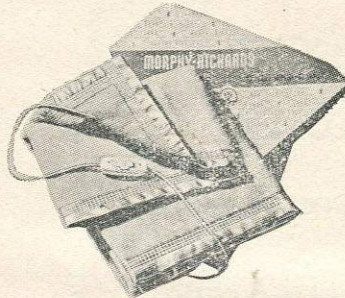

MORPHY-RICHARDS ELECTRIC BLANKETS

Series 3. Fast heating thermostatically controlled. A.C. only, 200/220, 230/250 volts.			
No. BBU3. Popular model. Single size: 48" × 26". 91 watts. Colour: Pink.			
SL26/4500	...	each	£3 0 0
Plus Purchase Tax 10/10			
No. BCU3. Popular model. Double size: 48" × 42". 159 watts. Colour: Pink.			
SL27/5802	...	each	£3 17 6
Plus Purchase Tax 14/-			
No. BSU3. Regent model. Single size: 60" × 26". 115 watts. Colours: Peach, Pink, or Blue.			
SL28/6706	...	each	£4 10 0
Plus Purchase Tax 16/3			
No. BDU3. Regent model. Double size: 60" × 45". 219 watts. Colours: Peach, Pink, or Blue.			
SL29/9706	...	each	£6 10 0
Plus Purchase Tax 23/6			
No. BEU3. Imperial model. Single size: 60" × 28". 124 watts. Colours: Peach, Pink, or Blue.			
SL30/8405	...	each	£5 12 6
Plus Purchase Tax 20/4			
No. BFU3. Imperial model. Double size: 60" × 47½". 228 watts. Colours: Peach, Pink, or Blue.			
SL31/12000	...	each	£8 0 0
Plus Purchase Tax 28/10			

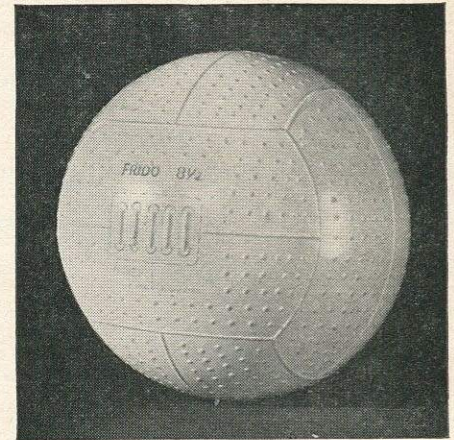

FRIDO RED VINYL FOOTBALLS

8½" diameter.			
SL34/3011	...	each	5/9½
Plus Purchase Tax 11½d.			

FRIDO WHITE VINYL "SNOWBALL"

8½" diameter.			
SL35/3011	...	each	5/9½
Plus Purchase Tax 11½d.			

FRIDO REPAIR KITS FOR ABOVE

SL36/1006 doz.	...	each	1/3
Plus Purchase Tax 2½d.			

FRIDO ADAPTORS ONLY

For 8½" balls.

SL37/107 doz.	...	each	2½d.
Plus Purchase Tax 5d. doz.			



TERRY'S BALL VALVE INFLATOR ADAPTOR

No. 976. Enables a cycle pump to be used for inflating footballs, air cushions, etc.

SL39/400 doz.	...	each	6d.
Plus Purchase Tax			

ALBION FOOTBALL LACING AWLS

SL40/Trade. No. 916	per doz.	6/4
---------------------	----------	-----

FOOTBALL BLADDERS

British Made

SL44/3600 doz.	Size 5	...	each 4/6
Plus Purchase Tax 9d.			

NEI 115

W. G. CHEESE LIMITED
CYCLE AND MOTOR ACCESSORIES, WIRELESS
AND ELECTRICAL SUNDRIES

JUPITER HOUSE
326-327, BRADFORD ST., BIRMINGHAM, 5
Telephone: MIDland 5804/5 (2 lines)

DARTBOARDS, DARTS, FOLDING CHAIRS & TABLES, 115 GASLIGHTERS



KWIZ DART FLIGHTS

Coloured Feather Flight on plastic spigot. Packed three flights per (window) box.

SL60/1703 doz. $2\frac{1}{2}$ " ... per set 2/2
 Plus Purchase Tax 4/3 Doz.
 SL62/2200 doz. 3 "- 5 " ... per set 2/9
 Plus Purchase Tax 5/3 Doz.

KWIZ

ALL-PLASTIC DART FLIGHTS

SL64/1000 doz. ... per set 1/3
 Plus Purchase Tax 2/5 Doz.

COMPETITION "T" DARTS

Sets of 3 packed in window box, assorted weights and body patterns with plastic flights. Varied colours.

SL67/2409 doz. sets ... per set 3/2
 Plus Purchase Tax 6d.



DESMO

"RESTAWILE" FOLDING CHAIR

No. 88. Can be used also as a picnic table. Fitted with tubular legs and complete with high-grade canvas in fast colour gay stripes. Chair back adjustable to two positions. Folds to 16 " \times $17\frac{1}{2}$ ". Weight, 7 lbs.

SL57/1804 *190.00* ... each *26/4*
 Plus Purchase Tax *2/2 1/2*

ASTRAL

CIGARETTE LIGHTER FLINTS

Supplied 36 packets on card.
 SL59/900 card ... per packet $4\frac{1}{2}$ d.

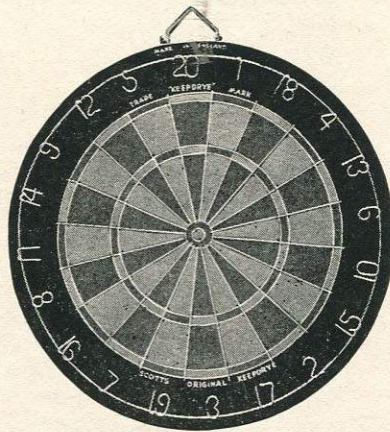

SCOTT'S "KEEPDRYE" DARTBOARDS

Double sided. Made from tightly wound paper, clearly numbered and coloured. 18 " \times 1 ".

SL56/800 ... each 12/-
 Price Plus Purchase Tax 1/11

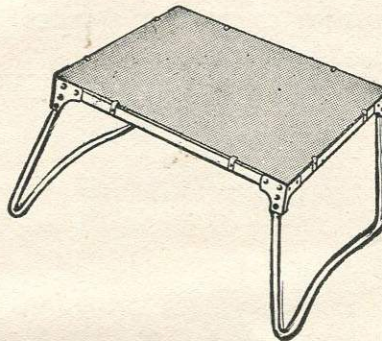

ASHBY FOLDING TABLE

No. 10. Size folded: 20 " \times 16 " \times $2\frac{1}{4}$ "; Size open: 20 " \times 16 " \times 14 " high. Weight: $5\frac{1}{4}$ lbs. Washable Nylon Flock sprayed top, with alternative colours Red and Yellow. Framework and legs stove enamelled.

SL76/1703 ... each 25/10
 Plus Purchase Tax 10d.

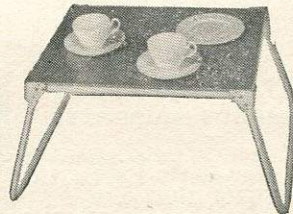

DESMO PORTABLE FOLDING TABLE

No. 99. Fitted with a simple but effective locking device on each tubular leg and can be moved without collapsing. Finish: Pastel Green top, legs and framework in Cream. Size of top, 20 " \times $15\frac{1}{2}$ ". Height, 13 ".

SL70/2104 ... each 28/6
 Plus Purchase Tax 1/1

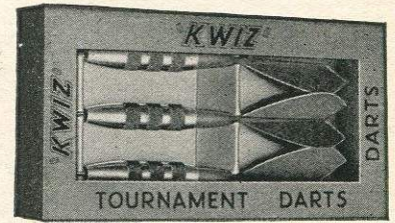

KWIZ DARTS

Sets of three packed in window box. In assorted weights and patterns. Feathered flight on plastic spigot.

SL78/4306 doz. ... per set 5/6
 Plus Purchase Tax 10/6 Doz.



ASHBY "RECLINA" FOLDING CHAIR

No. 3. Size folded: $17\frac{1}{2}$ " \times $15\frac{1}{4}$ "; Size open: $14\frac{1}{2}$ " \times $18\frac{1}{2}$ " high. Weight: $5\frac{1}{4}$ lbs. Gay coloured canvas.

SL80/1007 ... each 15/10
 Plus Purchase Tax 2/10

EVER READY GASLIGHTER

No. 2247. Brass, chromium-plated battery housing and stem. With burner but less battery.

SL/82/400 ... each 6/-
 Plus Excise Duty 4/-

EVER READY GASLIGHT BURNER

No. 2247/2. Spare burner for Gaslighter.

SL83/1200 doz. 1.5v. each 1/6

EVER READY GASLIGHTER BATTERY

SL84/110 No. U14 each 2/6



FLUORESCENT TUBES

SL68/808 ... each 13/-

Plus Purchase Tax 2/1

W. G. CHEESE LIMITED
 CYCLE AND MOTOR ACCESSORIES, WIRELESS
 AND ELECTRICAL SUNDRIES

JUPITER HOUSE
 326-327, BRADFORD ST., BIRMINGHAM, 5
 Telephone: MIDland 5804/5 (2 lines)

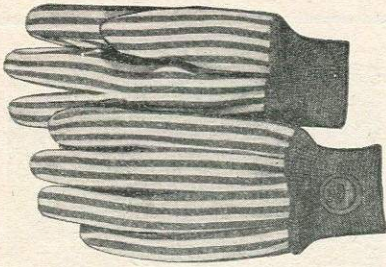

ANDYCYCLE GLOVES

Fleece lined

SL100/3006 doz. ... per pair 3/11
Plus Purchase Tax 1/5 Doz.

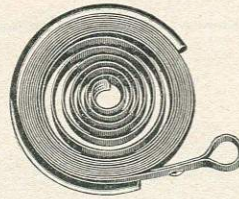

GRAMOPHONE SPRINGS

Please quote full details of Motor No. when ordering.



SONGSTER GRAMOPHONE NEEDLES

Loud. Supplied in boxes of 200 needles.

SL126/500 per 1,000 ... per box 1/6
Purchase Tax 2/6

Bronze. Supplied in boxes of 100 needles.

SL127/1000 per 1,000 ... per box 1/6
Purchase Tax 4/10

COUNTER Display Pack

Contains five different types of needles.

SL128/Trade ... per pack 31/11
Plus Purchase Tax 15/4

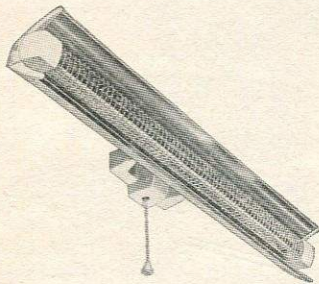

SUNHOUSE INFRA-RED HEATER

No. 167S. 750 watts. Pull switch. Specially valuable in kitchen, bathroom and nursery because of its great safety. Finished in Cream and chrome plate.

SL115/6702 ⁶⁷¹⁰ ... each £4 ⁴⁻¹⁰⁻⁶ 9-7
Tax Paid ¹⁶²⁻¹⁴⁴

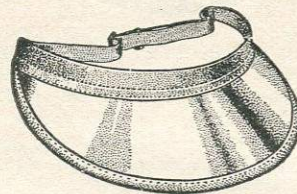

MIDLAND GREEN EYE SHADES

No. 133G. With adjustable strap.
SL110/106 ... each 2/3

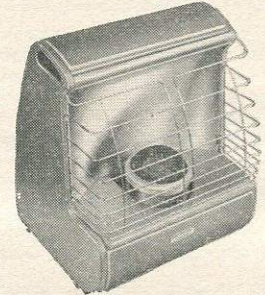

MONOBRIGHT PARAFFIN RADIANT HEATER

SL120/17000 ¹⁸⁷⁰¹ ... each £11 ¹²⁻⁹⁻⁵ 14-7
Plus Purchase Tax ⁵²⁻⁴⁴ 45/7

SL121/306 Wicks ... each 5/3

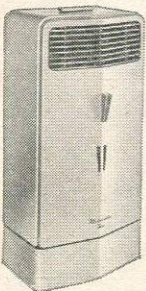

MONOVECTOR "ONE" SPACE HEATER

Height 30". Depth 11½". Width 19".

SL105/11907 ... each £7 19 6
Plus Purchase Tax 29/-



MONOVECTOR "TWO" SPACE HEATER

Height 26½". Depth 9½" (excluding front panel handle). Width 13".

SL107/11511 ... each £7 14 6
Plus Purchase Tax 28/3



MORPHY-RICHARDS HAIRDRYER

No. HDA/2. A.C. only, 50 cycles. Finish in Ivory, Blue, or Red. Voltages 110/120, 120/130, 150/160, 200/220, 220/240, 250/260.

SL130/4209 ... each £2 17 0
Plus Purchase Tax 10/4

MORPHY-RICHARDS HAIRDRYER STAND

No. HS. Chromium-plated stand.
SL131/309 ... each 5/-
Plus Purchase Tax 5d.

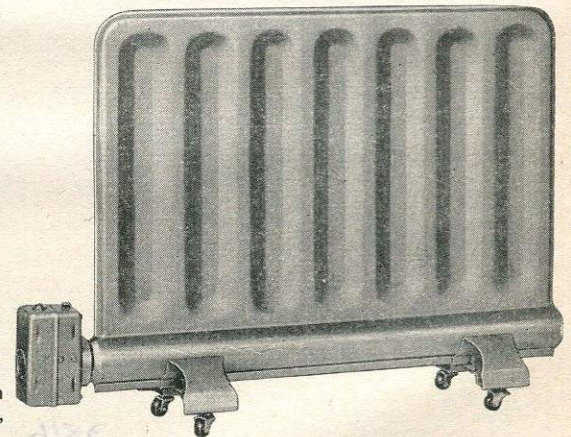

GRUBB (SEALED OIL) THERMOSTAT CONTROLLED ELECTRIC HEATERS

SL/140/16103 750 watt each £10 15 0
SL141/19800 1,000 watt each £13 4 0
SL142/26404 1,500 watt each £17 12 6
SL143/38206 2,000 watt each £25 0 0

With "Silent Dome" Feet.
Plus Purchase Tax

H 30

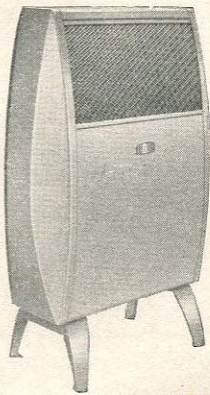

MORPHY-RICHARDS "CONWAY" CONVECTORS

- No. QU/10.** 1 kW. A.C./D.C. Colours: Pearl, Bronze, Charcoal or Ember Red.
SL166/7809 each **£5 5 0**
 Plus Purchase Tax 18/11
- No. QS/20.** 2 kW. A.C./D.C. 200/220, 230/250 volts, with half-heat switch. Colours as above. **SL167/9706** each **£6 10 0**
 Plus Purchase Tax 23/6
- No. QT/20.** 2 kW. A.C. only. 200/220, 230/250 volts, with thermostatic control. Colours as above.
SL168/10809 each **£7 5 0**
 Plus Purchase Tax 26/2

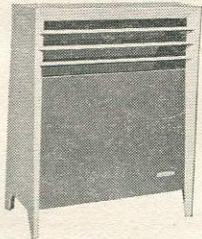

MORPHY-RICHARDS "SHEERLINE" CONVECTOR

- No. SHL.** 2 kW. A.C. only. 200/220, 230/250 volts. Thermostatically controlled. Colours: Pearl, Bronze and Ember Red, Charcoal or Blue.
SL170/9309 each **£6 5 0**
 Plus Purchase Tax 22/7

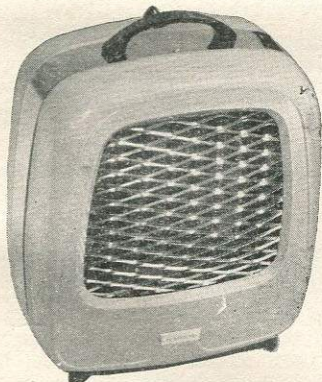

FAN HEATERS

- No. 226.** 2½ kW. Controlled by a thermostat. Finish: Cardinal Red and Chrome, Dove-Grey and Chrome.
SL172/9309 each **£6 5 0**
 Purchase Tax 22/6

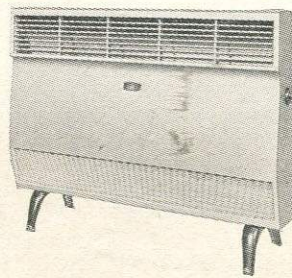

MORPHY-RICHARDS "DERWENT" CONVECTORS

- No. QBA/10.** 1 kW. A.C. only. 200/220, 230/250 volts. Pearl-Bronze only.
SL174/9706 each **£6 10 0**
 Plus Purchase Tax 23/6
- Charcoal or Ember Red.
SL175/10103 each **£6 15 0**
 Plus Purchase Tax 24/4
- No. QBA/20.** 2 kW. A.C. only. 200/220, 203/250 volts, complete with thermostat. Colour: Pearl-Bronze only.
SL176/14502 each **£9 13 6**
 Plus Purchase Tax 34/11
- Charcoal or Ember Red.
SL177/14811 each **£9 18 6**
 Plus Purchase Tax 35/10

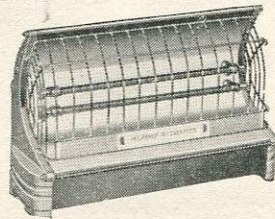

MORPHY-RICHARDS "CRAY" ELECTRIC FIRES

- No. FC/750.** ¾ kW. A.C./D.C. 110/120 volts. Colour: Pearl-Bronze.
SL180/3106 each **£2 2 0**
 Plus Purchase Tax 7/7
- Pearl Bronze with Red or Charcoal Finish.
SL181/3309 each **£2 5 0**
 Plus Purchase Tax 8/2
- No. FC/15.** 1½ kW. A.C./D.C. 110/120 volts. Finish: Pearl Bronze.
SL182/3905 each **£2 12 6**
 Plus Purchase Tax 9/6
- Pearl Bronze with Red or Charcoal finish.
SL183/4108 each **£2 15 6**
 Plus Purchase Tax 10/-
- No. FC/10.** 1kW. A.C./D.C. 200/220, 230/250 volts. Pearl-Bronze.
SL184/3411 each **£2 6 6**
 Plus Purchase Tax 8/5
- Pearl-Bronze with Red or Charcoal finish.
SL185/3711 each **£2 10 6**
 Plus Purchase Tax 9/2
- No. FC/20.** 2 kW. A.C./D.C. 200/220, 230/250 volts. Pearl-Bronze.
SL186/4302 each **£2 17 6**
 Plus Purchase Tax 10/5
- Pearl-Bronze with Red or Charcoal finish.
SL187/4602 each **£3 1 6**
 Plus Purchase Tax 11/1



MORPHY-RICHARDS "MEDWAY" RADIANT CONVECTORS

- No. QR/20.** 1 kW. fire and 1 kW. convector. A.C./D.C. 200/220, 230/250 volts. Colour: Pearl-Bronze only.
SL190/10500 each **£7 0 0**
 Plus Purchase Tax 25/3
- Charcoal or Ember Red.
SL191/10809 each **£7 5 0**
 Plus Purchase Tax 26/2
- No. QR/30.** 1 kW. fire and 2 kW. convector. A.C. only. 200/220, 230/250 volts. Colour: Pearl-Bronze only.
SL192/13103 each **£8 15 0**
 Plus Purchase Tax 31/7
- Charcoal or Ember Red.
SL193/13500 each **£9 0 0**
 Plus Purchase Tax 32/6

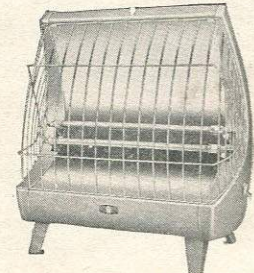

MORPHY-RICHARDS "AVON" ELECTRIC FIRE

- No. FA/20.** 2kW. A.C./D.C. 200/220, 230/250 volts. Pearl-Bronze, Charcoal or Ember Red. **SL196/6309** each **£4 5 0**
 Plus Purchase Tax 15/4



FAN HEATERS

- No. 225.** 2½ kW. 3-Speed fan, 3-heat switch. Illuminated grill. Height 13½" × Width 10", Depth 6". Finish Cardinal Red and Chrome, Dove Grey and Chrome.
SL198/11702 each **£7 16 2**
 Purchase Tax 28/2

E 83

W. G. CHEESE LIMITED
 CYCLE AND MOTOR ACCESSORIES, WIRELESS
 AND ELECTRICAL SUNDRIES

JUPITER HOUSE
 326-327, BRADFORD ST., BIRMINGHAM, 5
 Telephone: MIDland 5804/5 (2 lines)

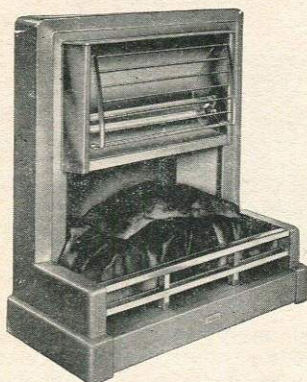
**COAL EFFECT HEATER**

No. 302. 2kW. Height, 21 $\frac{5}{8}$ "; Width, 21"; Depth, 9 $\frac{1}{2}$ ". Finish: Bronze or Grey.
SL210/15511 ... each £10 7 6
Purchase Tax 37/6

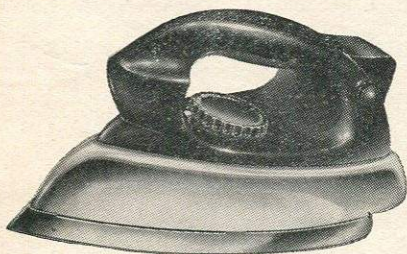
**MORPHY-RICHARDS
AUTO-CONTROL LIGHTWEIGHT
ELECTRIC IRONS**

No. LA/75. Atlantic. Coloured body. A.C. only. 100/120, 200/220, 220/240, 250/260 volts.
SL212/3111 ... each £2 2 6
Plus Purchase Tax 7/8

As above, but Chromium body.
SL213/3505 ... each £2 7 3
Plus Purchase Tax 8/6

**MORPHY-RICHARDS
IRON SPARES
SL218/Trade**

65521X Bow Thermostats ... each 7/6
30501T Soleplates 240v., Mk. 2 ... each 12/-
— Metal Bodies, asstd. cols. ... each 3/-
31675 Flexes ... each 5/7 $\frac{1}{2}$
14/5/6 Lamp Covers with
Contacts ... per doz. 16/6
— Control Knobs with Clips
per doz. 6/9
30643 Handles... ... each 4/6
30626 Asbestos Liners ... per doz. 4/6
30625/30629 Pins and Nuts (12) per pkt 6/9
31801T Elements ... each 4/10 $\frac{1}{2}$
36001 Body Motor Halves ... each 4/-
36002 Body Fan Halves ... each 3/9

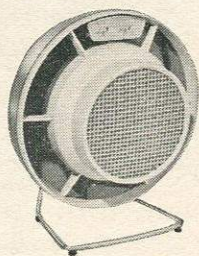

MORPHY-RICHARDS FAN HEATERS
No. FH. 2 kW. 3 Fan Speeds. Half-heat switch. Thermostatically controlled. A.C. only. 200/220, 220/240, 240/260 volts. Finish: Cinnamon, White and Red.
SL220/15706 ... each £10 10 0
Plus Purchase Tax 37/11

FIRE ELEMENTS (PENCIL)
Universal Adjustable
SL222/306 ... each 4/11
ELECTRIC FIRE SPIRAL WIRES
SL224/104 750 watts ... each 2/-
SL225/200 1,000 watts ... each 2/11

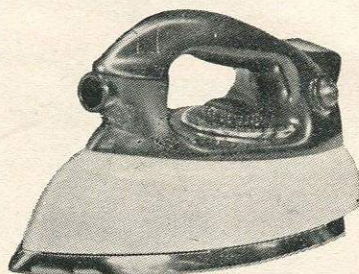

**MORPHY-RICHARDS
AUTO-CONTROL STEAM IRONS**
No. ZA/75. Chromium-plated body. A.C. only. 100/120, 200/220, 220/240, 250/260 volts.
SL227/4809 ... each £3 5 0
Plus Purchase Tax 11/9
PIFCO IRON ELEMENT
No. 540A.
SL228/2400 doz. ... each 2/9

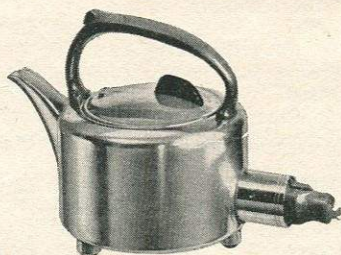

BESCOL KETTLES
No. 214. Polished aluminium with automatic safety device. "Good Housekeeping" guarantee. Complete with 4 ft. 3-core heavy flex and earthing connector.
SL23/4504 2,000 watts ... each 60/5
Plus Purchase Tax 10/11

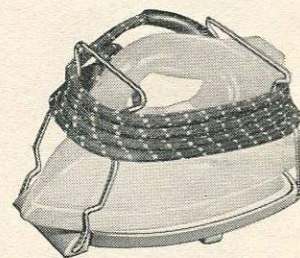

**MORPHY-RICHARDS
SAFETY IRON STAND**
No. S/3. Available in Primrose, Blue, Green and Silver.
SL234/600 ... each 8/-
Plus Purchase Tax 9d.

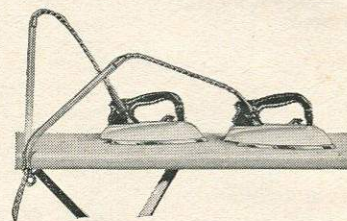

MORPHY-RICHARDS FLEX SUPPORT
No. FS/1. Keeps flex clear from work. Chromium-plated finish.
SL236/309 ... each 5/-
Plus Purchase Tax 5d.

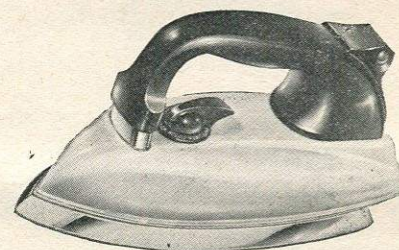

**MORPHY-RICHARDS
AUTO-CONTROL MIDWEIGHT
ELECTRIC IRONS**
No. CA/75. Senior. Coloured body. A.C. only. 100/120, 200/220, 220/240, 250/260 volts.
SL238/3009 ... each £2 1 0
Plus Purchase Tax 7/5
As above, but Chromium body.
SL240/3309 ... each £2 5 0
Plus Purchase Tax 8/2

W. & G. FLEX
No. 14/0076 Twin Maroon covered cotton. SL242/3200 100 yds. ... Retail 5d. yd.
No. 23/0076. Triple Maroon, non-kink. SL243/4200 50 yds. ... Retail 1/3 yd.
No. 23/0076. Twin Rubber Sheathed. SL244/3309 50 yds. ... Retail 1/- yd.
No. 40/0076. Triple Maroon Covered Cotton. SL245/4400 50 yds. ... Retail 1/4 yd.

PIFCO FLEX
No. 14/36. Twin Plastic. SL246/1806 100 yds. ... Retail 3d. yd.

C 201

W. G. CHEESE LIMITED
CYCLE AND MOTOR ACCESSORIES, WIRELESS
AND ELECTRICAL SUNDRIES

JUPITER HOUSE
326-327, BRADFORD ST., BIRMINGHAM, 5
Telephone: MIDland 5804/5 (2 lines)

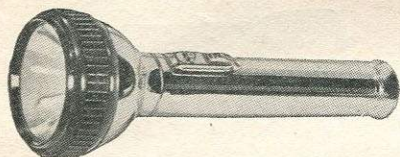

EVER READY SEARCHLIGHT PREFOCUS TORCHES
No. 2864P. 2 $\frac{3}{4}$ " dia. clear glass. Prefocus bulb. Knurled red moulded lens ring. Chrome plated. Takes two U2 batteries. Length 7 $\frac{1}{2}$ ".
 SL100/706 each 11/5
 Plus Purchase Tax 1/10

EVER READY SEARCHLIGHT PREFOCUS TORCHES
No. 3864P. Length 9 $\frac{3}{8}$ ". Takes three U2 batteries.
 SL101/804 each 12/6
 Plus Purchase Tax 2/-

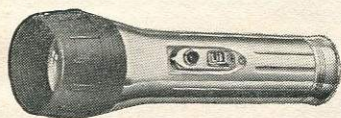

EVER READY FLARELIGHT PREFOCUS TORCH
No. 2367. Head 2 $\frac{1}{8}$ ". Length 7 $\frac{5}{16}$ ". Extruded seamless aluminium case. Prefocus bulb. Polished and anodised aluminium finish. Lens ring of high density red polythene. Takes two U2 batteries.
 SL102/402 each 6/3
 Plus Purchase Tax 1/-

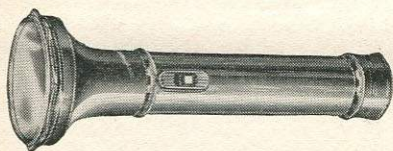

EVER READY FOCUSING TORCHES
No. 3864. 3" dia. head. Length 9 $\frac{1}{2}$ ". Takes three U2 batteries.
 SL104/700 each 10/6
 Plus Purchase Tax 1/9

EVER READY FOCUSING TORCHES
No. 3564. 2 $\frac{1}{4}$ " dia. head. Length 9 $\frac{1}{4}$ ". Takes three U2 batteries.
 SL103/608 each 9/11
 Plus Purchase Tax 1/7

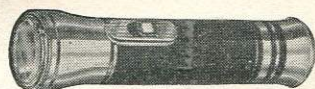

EVER READY SPOTLIGHT FIXED FOCUS TORCHES
No. 2358. Large Spotlight. 1 $\frac{3}{4}$ " head. Length 6 $\frac{3}{8}$ ". Takes two U2 batteries. Extruded aluminium case. Black and Electro Bright.
 SL108/304 each 5/-
 Plus Purchase Tax 9d.



EVER READY SPOTLIGHT FIXED FOCUS TORCHES
No. 1258. Baby Spotlight. 1 $\frac{1}{2}$ " head. Length 5 $\frac{1}{2}$ ". Takes two U11 or 1839 battery. Lens and reflector housing, plastic moulding. Black and Electro Bright.
 SL109/208 each 4/-
 Plus Purchase Tax 9d.



EVER READY SPOTLIGHT FIXED FOCUS TORCHES
No. 0158. Bijou Spotlight. 1 $\frac{1}{4}$ " head. Length 4 $\frac{1}{2}$ ". Takes two U8 or No. 8 battery. Black and Electro Bright.
 SL110/200 each 3/-
 Plus Purchase Tax 6d.

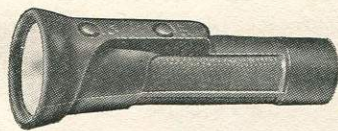

EVER READY RUBBER TORCHES
No. 2697. 2 $\frac{5}{8}$ " head. Length 8 $\frac{1}{4}$ ". Metal tube case enclosed in heavy rubber moulding. Bottom cap loading. Prefocus bulb. Colours: Red or Black. Takes two U2 batteries.
 SL112/700 each 10/6
 Plus Purchase Tax 1/9

EVER READY RUBBER TORCHES
No. 3697. Length 10 $\frac{1}{2}$ ". Takes three U2 batteries.
 SL113/808 each 13/-
 Plus Purchase Tax 2/-



EVER READY POCKET LAMP
No. 8188. Dimensions: Length, 1 $\frac{3}{4}$ " x width, $\frac{1}{8}$ " x height, 3 $\frac{7}{8}$ ". Takes two U10 batteries. Steel stove enamelled case, plated top and bottom cap. Moulded lens giving spot beam. Slide-type switch.
 SL120/202 each 3/3
 Plus Purchase Tax 6d.



EVER READY POCKET LAMPS
No. 9220. Standard. Dimensions: Length, 2 $\frac{5}{8}$ " x width, 1" x height, 4 $\frac{7}{8}$ ". Takes No. 1289 battery. Case stove-enamelled silver. Chrome-plated top and bottom steel caps, both hinged. 1 $\frac{1}{2}$ " bull's-eye lens. Slide switch.
 SL122/206 each 3/10
 Plus Purchase Tax 8d.



EVER READY SLIM PENLIGHT
No. 2216. $\frac{1}{2}$ " dia. head. Length 5". Takes two U16 batteries. Finished in polished chrome-plated or polished gilt lacquer. Combined sliding switch and fountain pen-type top.
 SL115/208 each 4/-
 Plus Purchase Tax 9d.

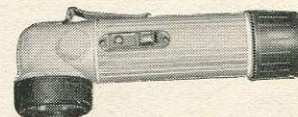

COMMANDO ANGLE HEAD TORCH
No. 2393. Head 2 $\frac{3}{8}$ ". Length 7 $\frac{7}{16}$ ". Plastic case. Bottom cap loading. Prefocus bulb. Spare bulb in bottom cap. Takes two U2 batteries.
 SL106/900 each 13/6
 Plus Purchase Tax 2/3

A 12 4

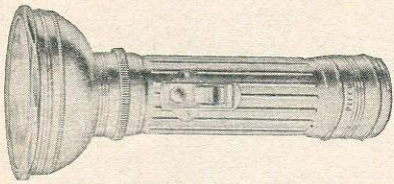

PIFCO RING-FOCUS TORCHES
No. 1478. Two-cell large, giant head torches. Size 7½" long. Bulb fitted 2.5v. Case and bulb.
 SL220/501 each 7/7
 Plus Purchase Tax 1/3

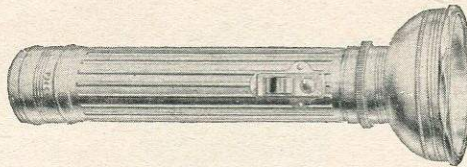

PIFCO RING-FOCUS TORCHES
No. 1465. Five-cell large, giant head torches. Size 14½" long. Bulb fitted 6.2 volts. Case and bulb.
 SL226/800 each 12/-
 Plus Purchase Tax 1/11½



PIFCO BIJOU TORCH
No. 1718. Slide action switch. Length 4⅝". 2.5v. spot bulb. Less battery.
 SL234/103 each 1/11
 Plus Purchase Tax 3½d.



PIFCO SHOCKPROOF TORCHES
No. 1722. Baby. 2" diameter head. Length of body, 5½". Case and bulb.
 SL222/211 each 4/4½
 Plus Purchase Tax 8½d.

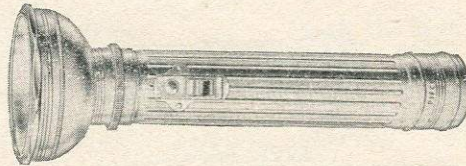

No. 1476. Three-cell large, giant head torch. Size 9⅝" long. Bulb fitted 3.5 volts. Case and bulb.
 SL227/602 each 9/3
 Plus Purchase Tax 1/6



PIFCO BABY SPOTLIGHT TORCH
No. 1728. Three-position switches for off, signal or permanent light, fitted with 2.5v. prefocus bulb. Length 5¾". Less battery.
 SL235/109 each 2/8
 Plus Purchase Tax 5½d.

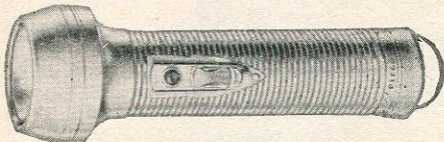

PIFCO SHOCKPROOF TORCHES
 Double-spring shock absorbers protect bulb and reflector assembly. Circular ribbed body, chromium-plated on brass. Ring hanger and three-position switch. Fitted with 2.5-volt prefocus bulb.
No. 1502. Two-cell Large. 2¼" diameter head. Length of body, 6⅝". Case and bulb.
 SL221/401 each 6/1
 Plus Purchase Tax 1/-

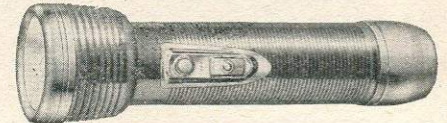

PIFCO LARGE SPOTLIGHT TORCH
No. 1485. Finished in anodised red, green, blue or gold. 2.5v. prefocus bulb. Size 7½" long. Case and bulb.
 SL236/203 each 3/4
 Plus Purchase Tax 6½d.



PIFCO NIGHTLAMP
No. 1669. A dual purpose night lamp and torch combined, chrome finish. 2.5v. prefocus and 2.5v. spot bulbs. Case and bulbs.
 SL230/409 each 7/2
 Plus Purchase Tax 1/2

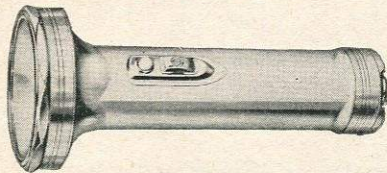

PIFCO SILVER STREAK TORCH
No. 1497. Square to round section body with large octagonal head. Size: 7¼" long x 3¼" dia. head. 2.5v. pre-focus bulb. Case and bulb.
 SL224/403 each 6/4
 Plus Purchase Tax 1/-

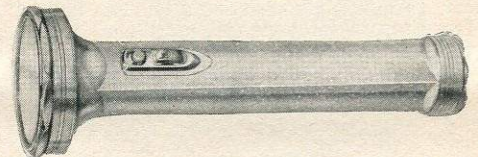

PIFCO SILVER STREAK TORCH
No. 1498. Size: 9⅞" long x 3¼" dia. head. Bulb fitted 3.5 v. pre-focus. Square to round section body with large octagonal head. Case and bulb.
 SL237/500 each 7/6
 Plus Purchase Tax 1/3

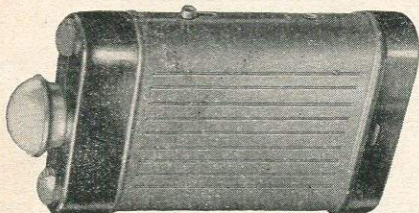

PIFCO THREE-COLOUR LAMP
No. 1235. Provides red, green or white light. Size 4½" x 2⅝" x 1". Bulb fitted 3.5v.
 SL225/108 each 2/6
 Plus Purchase Tax 5d.

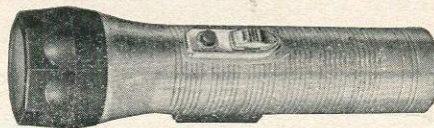

PIFCO MAGNETIC TORCH
No. 1494. Two-cell large torch with strong magnetic grip. Aluminium body with silver finish and red polythene lens cap. 7½" long x 2" dia. head. 2.5v. prefocus bulb fitted.
 SL233/403 each 6/4
 Plus Purchase Tax 1/-

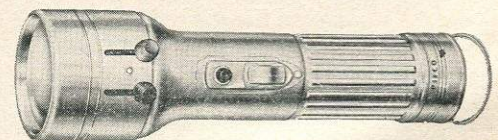

PIFCO SIGNALITE
No. 1496. Tricolour chrome-plated torch which provides red, green or white beam. Three-position switch and ring hanger. 2.5v. bulb fitted. Size 7¾" long x 2¼" dia. head. Case and bulb.
 SL239/307 each 5/5
 Plus Purchase Tax 11d.



PIFCO STARLIGHTS

No. 1249. Twelve large size permanent contact olive-shaped lamps in bright and attractive colours. Insulated lampholders in black plastic, each with skirt. Lamps: 1" dia. x 3" overall. Wired with 17 feet plastic flex and B.C. fitting. Voltages: 200/250. A.C./D.C.
SL360/1405 each 19/3
 Plus Purchase Tax 1/9

NOMA FAIRYLIGHTS

Standard 12-light decoration set.
SL367/1008 each 15/3
 Plus Purchase Tax 1/4
 Spare lamps for above.
SL368/700 doz. 10/-
 Plus Purchase Tax 1/8 doz.
 Flasher lamps for above.
SL369/1208 doz. doz. 18/-
 Plus Purchase Tax 3/1 doz.
 Tiny light sets, 20 screw-cap lamps.
SL370/1400 set 20/-
 Plus Purchase Tax 1/8
 Spare lamps for above.
SL371/500 doz. 7/-
 Plus Purchase Tax 1/2 doz.
 8-light Bubblelite sets.
SL372/2100 set 30/-
 Plus Purchase Tax 2/7
 Spare lamps for above.
SL373/700 doz. doz. 10/-
 Plus Purchase Tax 1/8 doz.



PIFCO FLASHER

No. 1374. Flashing Lampholder Adaptor in bakelite, to flash intermittently. Standard B.C. fitting. For flashing Decoration Sets, also lamps 30/40 watts.
SL382/308 each 4/11



PIFCO MAINS NURSERY LAMP

No. 985. In pastel shades of plastic, Ivory, Blue, Pink or Green. Matching shade with coloured nursery motifs. For 200/250 volts.
SL364/1208 each 16/10
 Plus Purchase Tax 3/1



PIFCO MUSICAL NURSERY LAMP

No. 1668. Plays a delightful nursery melody accompanied by soft and mellow light. Crinoline lady rotates. In assorted colours. 2.5-volt bulb fitted. Size 5" x 3 1/2" x 7". Case and bulb.
SL362/1907 each 29/5
 Plus Purchase Tax 4/9



PIFCO LULLABY LIGHT

No. 1662. Pastel-toned plastic, all pink or blue and green base with ivory shade. Dimensions: 7" x 4 3/8". 2.5 volt fitted bulb and case.
SL363/311 each 5/11
 Plus Purchase Tax 1/-

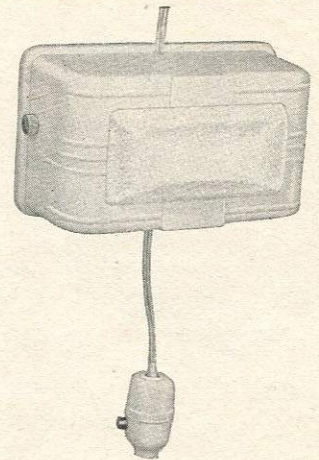

PIFCO MAINS AND BATTERY BEDLITES

No. 975. In pastel plastic with satin-glass lens. Hanger supplied. Various colours. Mains Model. 15-watt lamp included.
SL378/1005 each 13/11
 Plus Purchase Tax 2/7
No. 1642. Battery Model. 2.5-volt bulb fitted. Case and bulb.
SL379/702 1/2 each 10/10
 Plus Purchase Tax 1/9

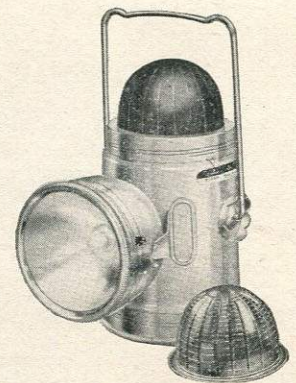

PIFCO RED DOME HAND LANTERN

No. 1440. The red dome flashes warning signals while the front lamp directs a broad pre-focused beam. Fitted with 5.2 v. pre-focus and a 6.0 v. bulb. Size 8" x 5 1/2" x 4".
SL385/903 each 13/11
 Plus Purchase Tax 2/3



**"SKY COUNTESS"
PORTABLE RECEIVER**

Compact cabinet of wooden construction covered in Rexine. Interior top panel of straw-coloured Vynair. Size 9" x 9" x 3 5/8". Weight 6 lbs. 3 ozs. including batteries. Self-contained ferrite rod aerial. Printed 4-valve circuit. Wavebands: Medium 190-550 metres and Long 1050-1870 metres. 5" speaker. Takes Batrymax B126 (90 volt H.T.) and Alldry AD35 (1 1/2 volt L.T.)

SL391/12110 each £9 2 10
Plus Purchase Tax £2 18 8

**SKY BARONET
PORTABLE RADIO RECEIVER**

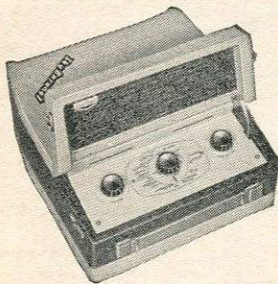

Cabinet of modern compact design wooden construction, 2-tone colour Vynair material, beige and French blue. Easy grip carrying handle. Size 10" x 10" x 4". Weight 7 3/4 lbs. including battery. Self contained ferrite rod aerial. A socket is provided for connection to standard car aerial. 4-valve superhet printed circuit. Wavebands: Medium 109-550 metres and Long 1050-1870 metres. 5" speaker. Takes Batrymax B141 combined 90 volt H.T. and 1 1/2 volt L.T. Battery.

SL390/13206 each £9 18 9
Plus Purchase Tax £3 3 9

**"SKY QUEEN"
PORTABLE RADIO RECEIVER**



Strong wooden cabinet covered in Rexine coloured in Indian red and white. Size 11 3/4" x 6 5/8" x 9 1/4". Weight 12 lbs. including battery. Socket is provided for connection to a standard car aerial, etc. Wavebands: 192-550 Medium and Long 950-2000 metres. 5" speaker. Takes Batrymax B136 combined 90 volts H.T. and 1 1/2 volts L.T.

SL393/13710 each £10 6 8
Plus Purchase Tax £3 6 4

**"SKY LEADER"
TRANSISTOR
PORTABLE RECEIVER**



Wooden cabinet covered in attractive tan-coloured Rexine. Size 9 3/8" x 3 1/2" x 7 1/2". Adjustable carrying handle. Weight 4 lbs. 14 ozs. including battery. Built-in rod aerial. A socket is provided for connection to a standard car aerial, etc. 6 transistor circuit. Wavebands: Medium 187-550 metres and Long 1110-1182 metres. 4" speaker. Takes battery Power Pack PP9.

SL392/23806 each £17 17 9
Plus Purchase Tax £5 14 9



PIFCO "PRINCE" ELECTRIC SHAVER

No. 1127. With "Varishave" precision speed adjustment and a "Pop-Up" long hair trimmer. Styled in Ivory and Grey Plastic with matching case. Complete with 5 feet detachable flex and 5-amp. 2-pin plug fitted. 200/250 volt. A.C. only.

SL398/7509 each 101/-
Plus Purchase Tax 18/6

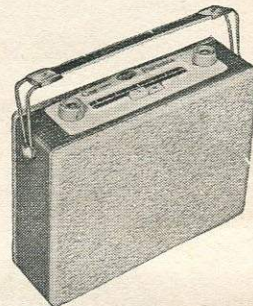

EVER READY CAR PORTABLE RADIO

This is the first portable that is truly a car radio. Fully transistorised. Only 5 lbs. including battery. In a modern styled wooden cabinet covered in mottled Red-White, polka dot 'Storoflex' and mottled Light Grey 'Vynair'. Size: 9 1/2" x 7 1/2" x 3 1/8". Superhet wired circuit utilizing six transistors. Wavebands: Medium, 187-550; Long, 1100-1900 metres. Speaker, as a portable, internal high sensitive, 4" dia. As a car radio, an 8" x 5" high flux elliptical speaker is provided, complete with baffle and lead.

Output, as a portable, undistorted output of 400 milliwatts, as a car radio, undistorted output of 1 watt. Panel bulb, No. 2604, 6 v. .04 amps. Battery, as a portable, Ever Ready Power Pack PP9. Operates for approximately one-fifth of a penny per hour under normal conditions. As a car radio, operates only from a 12 volt electrical system.

Aerial: as a portable, Internal ferrite rod, as a car radio, External car aerial.

Accessories for use as a Car radio, Metal screening box complete with battery leads, fuse and filter unit. Extension loudspeaker with baffle and lead. Mounting brackets, angles, screws and nuts.

Receiver including Battery and Accessories £20 18 2
Plus Purchase Tax £6 14 1



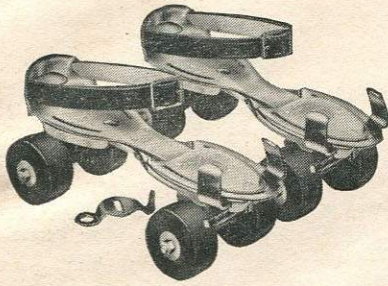

PHILLIPS ROLLER SKATES

No. 4. Adjustable. Fitted with rubber wheels and leather webbed toe pieces.

SL310/2044 ^{29/11} 19 05 ... per pair 31 5

Plus Purchase Tax 5 4/8

PHILLIPS SPARE SKATE WHEELS

SL311/1400 doz. Rubber ... each 1/9

SKATE KEYS

SL312/208 doz. ... per doz. 4/-

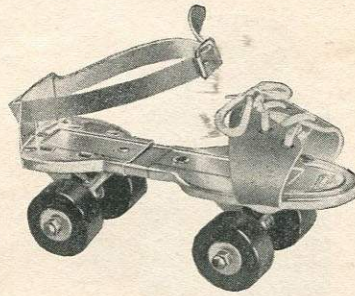

DAVIES ROLLER SKATES

Type 11. Fitted lace-up toe caps. Adjustable from 8" to 10½".

SL315/1309 ... each 20/6

Purchase Tax 3/3

DAVIES ROLLER SKATES

Type 10. Fully adjustable. Rubber wheels.

SL317/1006 ... per pair 15/9

Purchase Tax 2/6

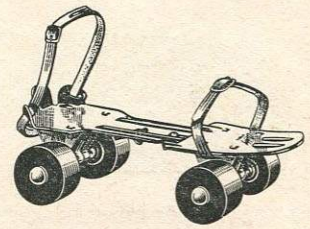

ASHBY ROLLER SKATES

No. 27. Fitted with plain bearing nylon bushed rubber wheels, adjustable platform with a bright finish.

SL270/1004 ... per pair 15/6

Plus Purchase Tax 2/6

HOOD FIXING WING BOLTS

SL329/804 doz. Chromium plated each 1/-

PRAM BODY STRAPS

SL330/800 doz. 9" x 1" ... each 1/-

ASTRAL LIGHTER FLINTS

Supplied 36 packets on card.

SL348/900 card ... per packet 4½d.

HUBCAR PRAMS/FOLDERS

Lists on Application

PRAM CAT NETS

SL318/406 ... each 6/9

PRAM FLY NETS

SL319/503 ... each 7/11

PRAM BRAKES

SL320/200 ... each 3/-

PRAM HOOD CORNERS

Chromium plated, with leather shield, Black, Maroon or Blue. Supplied 12 per card.

SL328/500 card ... each 7½d.



MORPHY-RICHARDS SUCTION CLEANER

No. VBA. Two-tone Bronze and Beige. Complete with accessories. A.C. 775/950w. 200/220, 220/240, 240/260 volts.

SL314/30708 ... each £20 10 2

Plus Purchase Tax 74/1

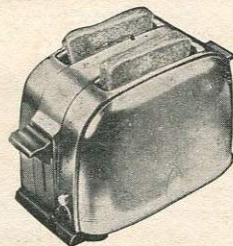

MORPHY-RICHARDS AUTO ELECTRIC TOASTER

No. TU/1D. A.C./D.C. 1,250 watts. 110/120, 120/130, 150/160, 200/220, 220/240, 250/260 volts. Chromium plated.

SL350/8502 ... each £5 13 6

Plus Purchase Tax 20/6

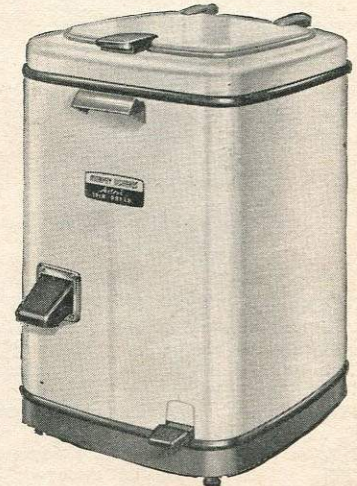

ASTRAL SPIN DRYERS

No. SBU/1. Holds 30 lbs of wet clothes (8½ lbs. dry weight).

SL376/29307 ... each £19 11 5

Plus Purchase Tax 70/7

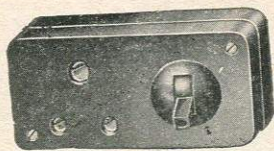

5-AMP. 3-PIN SCREENED SOCKET WITH SWITCH AND PLUG
 No. E18/274. Ceramic Interior. The shutter device screens the current-carrying contacts when plug is withdrawn. Brown.
 SL251/310 each 5/3

15-AMP. 3-PIN SCREENED SOCKET WITH SWITCH AND PLUG
 No. E107/98/52. Brown.
 SL252/500 each 6/9

13-AMP. 3-PIN SWITCH, PLUG AND SOCKET
 No. E/229/365W. Cream.
 SL253/704 each 9/9

13-AMP. 3-PIN PLUG
 No. E/229. Fused. Brown.
 SL254/2500 each 2/11
 /2900 Fused. Cream each 3/3

MULTI-SOCKETS
 No. E57/W. 13-amp., 3-pin, 2-way. Cream.
 SL256/5000 doz. each 5/6
 No. E/162/W. 15-amp., 3-pin, 3-way. Cream.
 SL257/5109 doz. each 5/9



PIFCO INSULATED STAPLES
 Sturdy square-headed copper staples with brown fibre lined insulation. Sizes: $\frac{3}{8}$ ", $\frac{1}{2}$ ", $\frac{5}{8}$ ", $\frac{3}{4}$ ". In printed boxes of 100 any size and outer display of 1,000 staples.
 No. 1576. Carton of 1,000 staples (10 boxes of 100), state size required.
 SL258/1204 per carton 16/6
 No. 2576. $\frac{1}{2}$ " or $\frac{5}{8}$ " staples, assorted, Red, Green, Brown, Cream and White. 40 boxes of 25.
 SL259/1500 per carton 20/-
 No. 2576W. 40 boxes of 25, White.
 SL260/1500 per carton 20/-
 No. 2576B. 40 boxes of 25, Brown.
 SL261/1500 per carton 20/-
 No. 2576C. 40 boxes of 25, Cream.
 SL262/1500 per carton 20/-

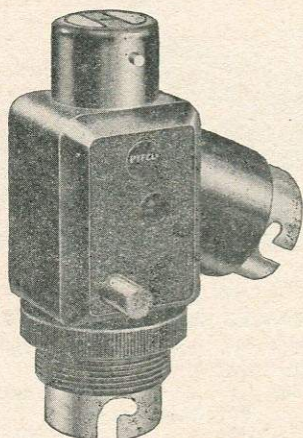

PIFCO TWO-WAY ADAPTOR
 No. 1375. Two-way parallel lampholder, Standard B.C.
 SL269/2409 doz. each 2/9



W. & G. 5-AMP. TUMBLER SWITCHES
 No. E/601. Surface Pattern. Ceramic Bases. Overall dimension: $2" \times 1\frac{3}{8}"$. 1-way. Brown.
 SL270/1606 doz. each 1/10
 No. E/60/W. White.
 SL329/1800 each 2/-

MINIATURE TUMBLER SWITCHES
 No. E/24. Plated.
 SL271/1103 doz. each 1/4

W. & G. M.E.S. MINIATURE BULB HOLDERS
 No. E/462. Moulded.
 SL272/400 doz. each 6d.

W. & G. ELECTRIC IRON CONNECTORS
 No. E/248. Angled entry.
 SL273/1106 doz. each 1/4



W. & G. B.C. LAMPHOLDER ADAPTOR
 No. E/144. Size of hole entry, $\frac{5}{16}"$. Brown.
 SL274/506 doz. each 7½d.

W. & G. LAMPHOLDER
 No. E/37. Solid Plungers. Cord Grip.
 SL276/706 doz. each 10d.
 No. E/43. Screwed with Switch.
 SL277/2700 doz. each 3/-



SPUR TURPENTINE SUBSTITUTE
 SL283/703 doz. 8-oz. Bottles each 10½d.
 SL284/1206 doz. 16-oz. Bottles each 1/6

CROID UNIVERSAL GLUE
 A pure, general-purpose glue.
 SL286/904 doz. per doz. 14/-



W. & G. 15-AMP. 3-PIN PLUG
 No. E/109. Side Entry. Circular Pattern.
 SL292/1406 doz. each 1/10



W. & G. 15-AMP. 2-PIN PLUG
 No. E/94.
 SL296/1200 doz. each 1/4

W. & G. 5-AMP. 3-PIN PLUG
 No. E/18. Circular Pattern. Brown.
 SL294/909 doz. each 1/1

W. & G. TOP ENTRY PLUGS
 No. E/90. 5-Amp. 2-Pin. Round Pattern. Brown.
 SL298/511 doz. each 8d.
 No. E/141. 2-Amp. 2-Pin. Brown.
 SL300/803 doz. each 11d.



W. & G. BATTEN LAMP HOLDERS
 No. E/51. Batten B.C. Moulded.
 SL302/1100 doz. each 1/3



PIFCO FUSE WIRE
 No. 1116. Each card wound with a good supply of three grades of Fuse Wire, 5, 15 and 30 amp. In carton containing 6 dozen cards.
 SL309/1400 per carton 21/-

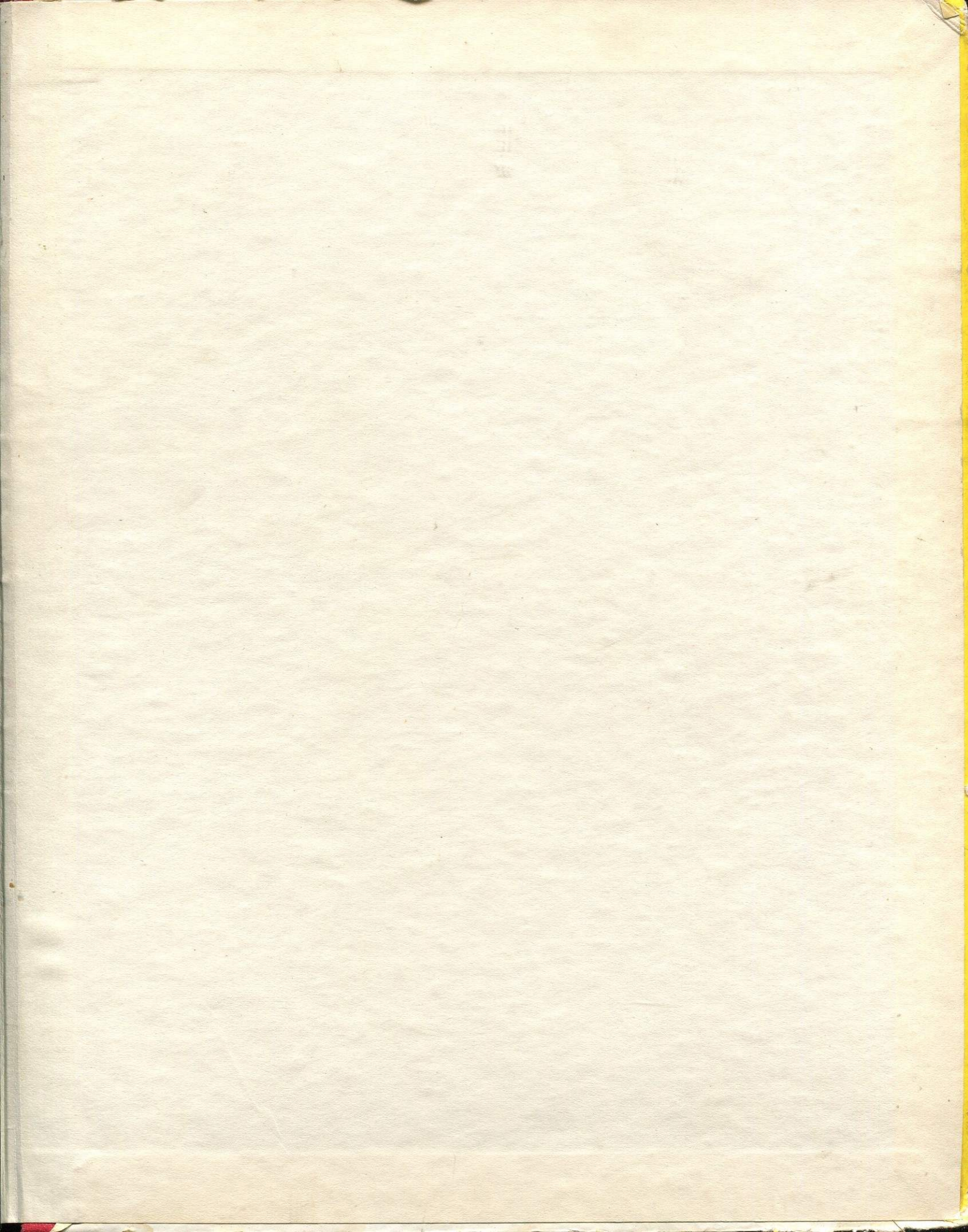

**ACCESSORIES
AND
SPARE PARTS**

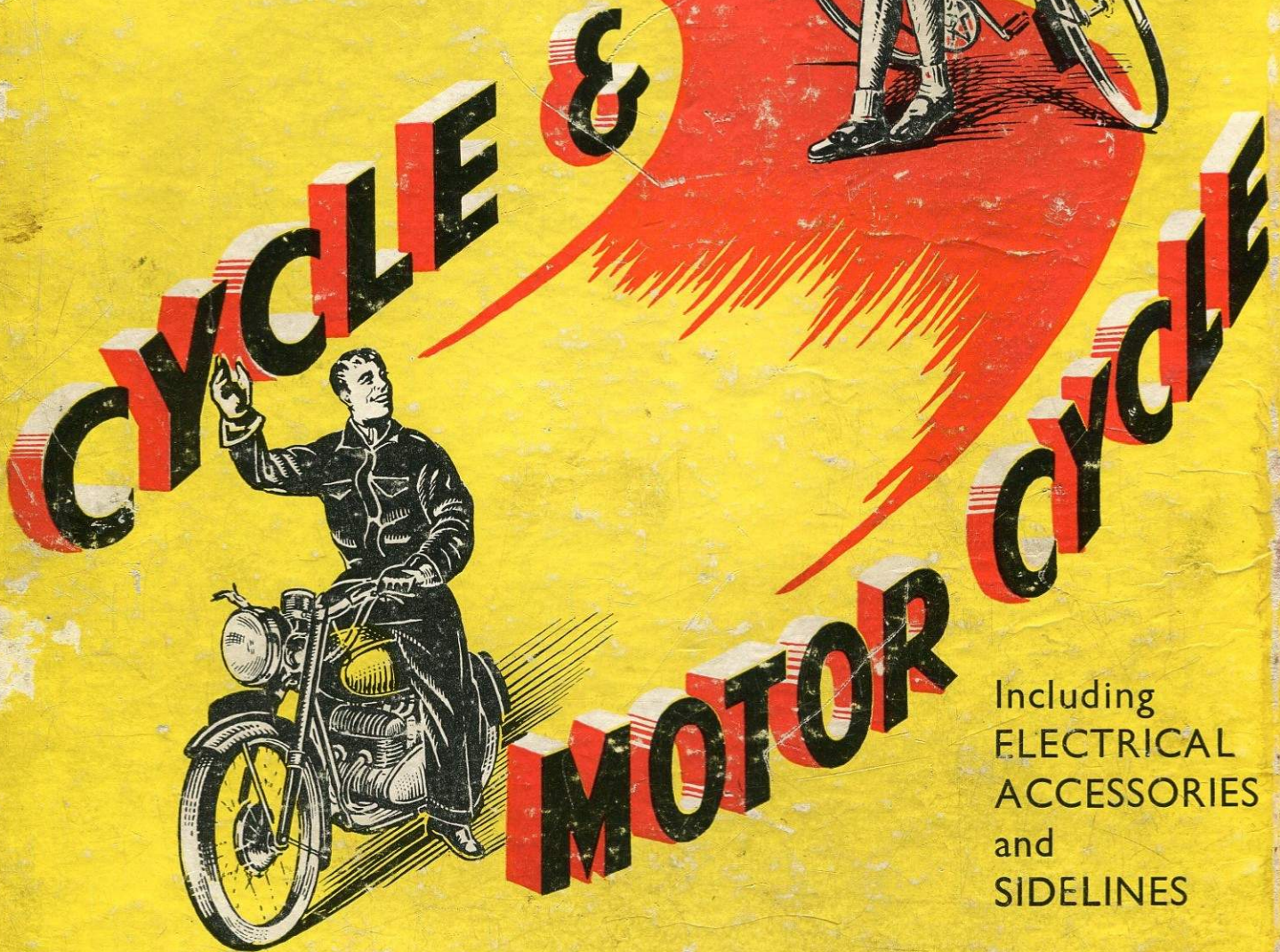

Including
ELECTRICAL
ACCESSORIES
and
SIDELINES

W. G. CHEESE LTD.

**JUPITER HOUSE, 326 - 327 BRADFORD STREET
BIRMINGHAM, 5**

Telephone : MIDLAND 5804/5 (2 lines)

Telegrams : MIDLAND 5804 BIRMINGHAM

IceniCAM On-Line Library

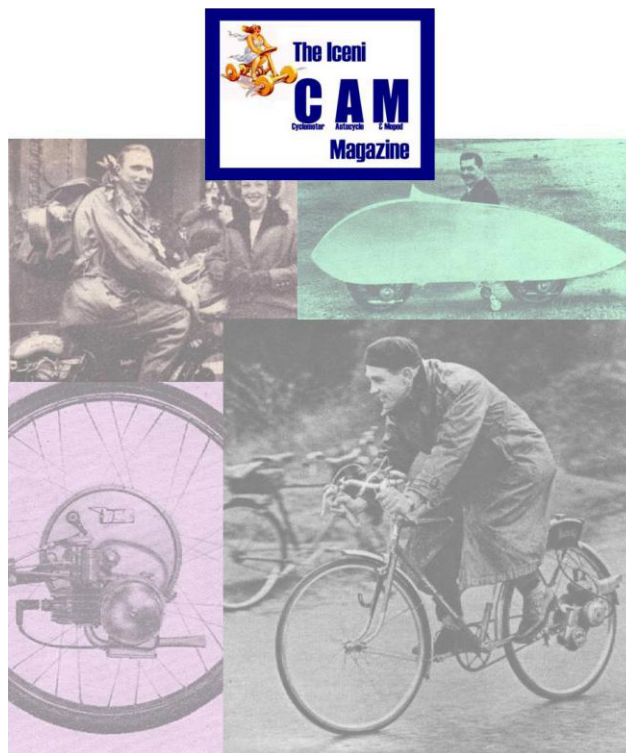

www.icenicam.org.uk