

RALEIGH

Automatic

MARK II

MODEL R M 8

**RIDING AND
MAINTENANCE
INSTRUCTION
BOOK**

6200794

PRICE 3/6

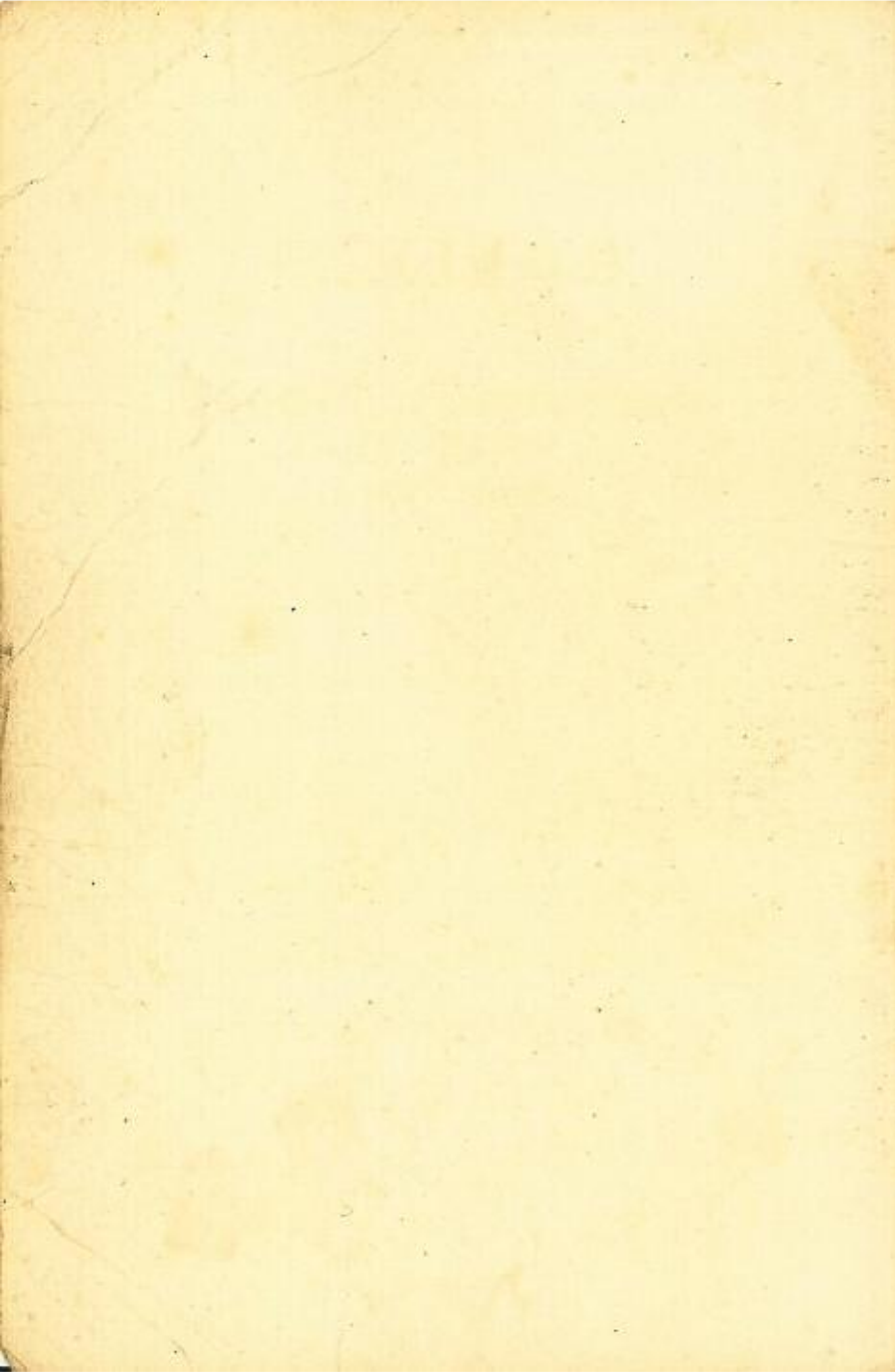

RALEIGH

Automatic Moped

MARK II

MODEL R M 8

**RIDING AND
MAINTENANCE
INSTRUCTION
BOOK**



IceniCAM Information
Service

RALEIGH INDUSTRIES LIMITED

LENTON BOULEVARD

NOTTINGHAM

TELEPHONE NOTTINGHAM 77761 TELEGRAMS RALIND NOTTINGHAM,
TELEX NOTTINGHAM 37681

- (8) Engine flooded with fuel due to excessive use of choke control: remedy as in point 7.
- (9) Choke plunger in carburettor not returning: check plunger and operating cable and adjust as necessary. Remedy as in point 7.
- ★ (10) Water in fuel: drain fuel system, clean out carburettor. Refill with correct fuel.

(B) Faulty ignition due to:—

- (11) Dirty or oiled sparking plug: clean the plug.
- (12) Sparking plug electrodes gap too wide: reset the gap. If the electrodes are badly burnt or corroded, replace the plug.
- (13) Faulty or broken sparking plug insulator: replace the plug.
- (14) Sparking plug lead disconnected: refit.
- (15) Insulation of H.T. lead to sparking plug faulty and spark shorting to earth: wrap the lead temporarily with insulating tape and replace it as soon as possible.
- (16) Dirty or loose connection in ignition circuit: check all connections and clean or tighten as necessary.
- (17) Dirty, burnt or maladjusted contact breaker points: clean or re-face points and set to correct clearance.
- (18) Condenser or external H.T. ignition coil faulty: have them checked.
- (19) **Note**—The sparking plug could get “wetted” with fuel due to carburettor flooding or to faulty ignition. It could be fouled by descending a long hill without opening the throttle occasionally or by letting the engine run light for too long. A sparking plug running too hot may cause the engine to stop due to “whiskering,” which is the formation of a conducting filament between the electrodes. A sparking plug running too cold fouls easily.

INTRODUCTION

Our objective in producing the R M 8 "Automatic" has been to provide motorised transport which is inexpensive to buy, economical to run and easy to ride and maintain. This machine incorporates the latest Continental technical developments and is manufactured to traditional Raleigh standards of craftsmanship and quality.

To keep your machine running efficiently and economically, it is essential that you follow the operating instructions and regularly carry out certain simple maintenance tasks. The necessary information and advice is contained in this handbook and it is in your own interest to study it carefully.

Authorised Raleigh Service Dealers throughout the British Isles are fully equipped to carry out any maintenance or repairs that you may require, or to supply you with Genuine Raleigh Spare Parts for replacements. If you wish to do your own repairs, ask your Dealer for details of the special service tools available.

INDEX

	Page
TECHNICAL DATA	6
RECOMMENDED LUBRICANTS	8
THE CONTROLS	9
RUNNING-IN INSTRUCTIONS	12
BEFORE TAKING THE MOPED ON THE ROAD	13
STARTING THE ENGINE	14
RIDING THE MOPED	14
PERIODIC MAINTENANCE	15
LUBRICATION OPERATIONS IN DETAIL	
Control cables and other moving parts	17
Freewheel	17
Automatic clutch	18
Bottom bracket pulley bearings	18
Chains	18
Telescopic front forks	18
Wheel hubs	18
Brake cam spindle	18
VARIOUS MAINTENANCE AND ADJUSTMENT OPERATIONS	
Driving belt removal and adjustment	19
Chain adjustment	20
Wheel removal	21
Handlebar controls adjustment	22
Cleaning the carburettor	24
Servicing the ignition equipment	25
Headlamp alignment	27
Decarbonising	27
Steering head adjustment	30
Care of tyres	30
Cleaning the Moped	31
Electrical-circuit diagram	32
FAULT FINDING	33

TECHNICAL DATA

Frame Number

Location... .. L.-H. frame lug above rear wheel spindle nut.

Engine Number

Location... .. Lower front of cylinder barrel.

Engine

Type Single cylinder, 2-stroke.
 Bore 39 mm.
 Stroke 41.75 mm.
 Cubic capacity 49.9 c.c.'s.

Clutch

Type Automatic, centrifugally operated.

Primary Drive

Type Vee-belt.
 Ratio 3.76 : 1.

Final Drive

Type Roller chain.
 Ratio 3.67 : 1 (44t to 12t).
 Chain size $\frac{1}{2}'' \times \frac{3}{16}'' \times .305''$ roller \times 96 pitches.

Pedal Drive

Type Roller chain.
 Ratio 1.78 : 1 (32t to 18t).
 Chain size $\frac{1}{2}'' \times \frac{1}{8}'' \times .305''$ roller \times 93 pitches.

Overall Gear Ratio ... 13.8 : 1.

Fuel Supply

Fuel tank capacity ... 1½ galls.
 Carburettor:—
 Make GURTNER
 Model B.A.10. 540 D.
 Main jet No. 20.

Electrical System

Type Flywheel magneto-generator, NOVI Model 120X, with external H.T. ignition coil.

Ignition:—

Sparking plug Lodge HN, Champion L86, K.L.G. F 75.
Sparking plug gap $\cdot 016''$ — $\cdot 018''$.
Contact breaker gap $\cdot 016''$ — $\cdot 018''$.

Lighting:—

Headlamp diameter 4.0".
Headlamp bulb 6v, 15/15 w.
Rear lamp bulb 6 v., 3 w., S.C.C.

Tyres

Size 23" \times 2".
Tyre pressures
(lbs. per sq. in.) Front, 24. Rear, 38.

RECOMMENDED LUBRICANTS

		BP	Castrol	Esso	Mobil	National Benzole	Shell
Engine (Petrol/oil ratio shown in brackets)	Two-Stroke Oils	Energol Two-Stroke Oil (20 : 1)	Two-Stroke Self-mixing Oil (16 : 1)	Esso Two-Stroke (2T) Motor Oil (16 : 1)	Mobilmix TT (16 : 1)	—	Shell 2T Two- Stroke Oil (20 : 1)
	Pre-Mixed fuels	BP-Zoom (20 : 1)	—	—	—	Hi-Fli* (20 : 1)	Shell 2T Mixture (20 : 1)
Running in: Where a (20 : 1) ratio is specified, use (16 : 1) for running in. Where a (16 : 1) ratio is specified, use (12 : 1) for running in.							
Chains	Grade	Energol SAE 50	Grand Prix	Esso Extra Motor Oil 40/50	Mobiloil BB	—	Shell X-100 50
Working Joints, Control Cables, etc.	Grade	Energol SAE 20W	Castrolite	Esso Extra Motor Oil 20W/30	Mobiloil Arctic	—	Shell X-100 20W
All Greasing Applications	Grade	Energol L2	Castrolase LM	Esso Multi- purpose Grease H	Mobil- grease MP	—	Retinax A

*NATIONAL BENZOLE CO. LTD., ALSO MARKET SHELL AND BP LUBRICANTS

THE CONTROLS

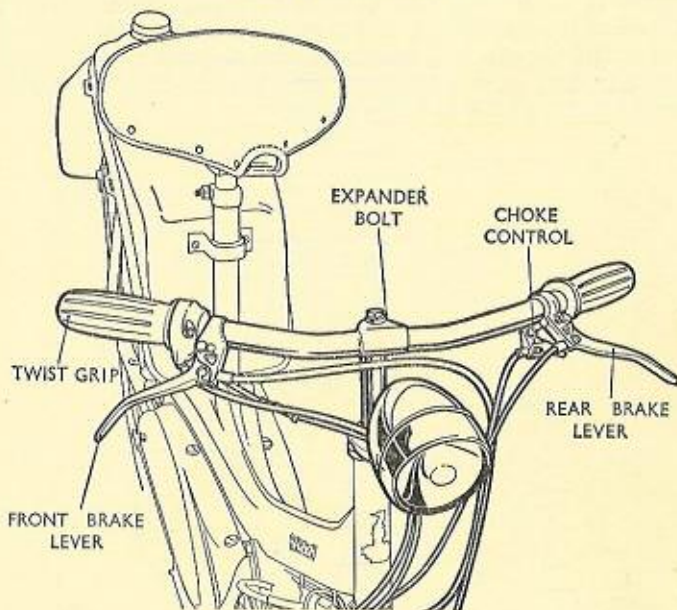

Fig. 1

Brake Levers

These are mounted on the handlebar in a similar manner to those of a pedal cycle. The front brake lever is on the right and the rear brake lever on the left.

Choke Control

This is a small lever beneath the left handlebar. Its purpose is to provide a "rich" fuel mixture for starting the engine from cold. This control should be used as little as possible and never when the engine is warm.

Twistgrip

The right-hand handlebar grip is free to rotate. Rotation away from the rider opens the engine decompressor valve,

so releasing the engine compression to stop the engine, or to enable it to be pedalled over more easily when starting. Rotation towards the rider restores the engine compression and opens the throttle, thereby controlling the engine speed. Between the two is a "neutral" position at which the engine should be set to run at idling speed.

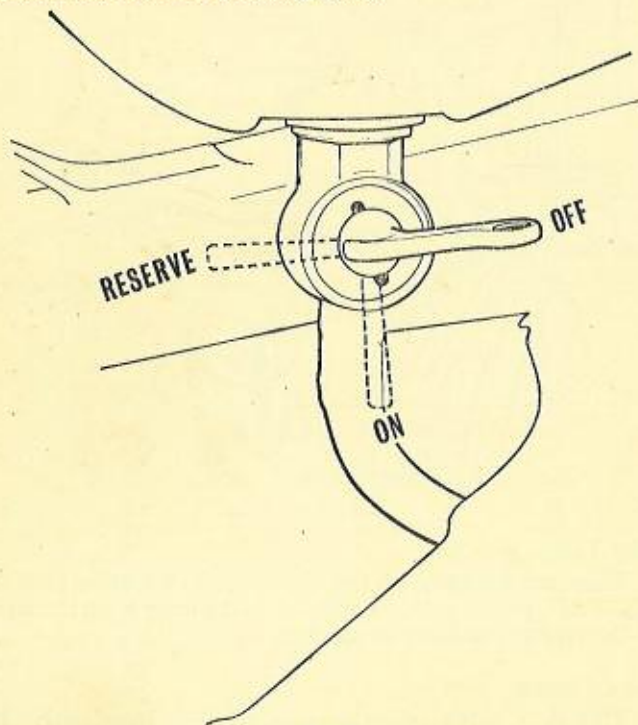

Fig. 2

Fuel Tap

The tank of this model has a fuel tap provided with "on," "off" and "reserve" positions. Normally when using the machine, the tap should be switched to "on." The "reserve" position releases a small additional amount of fuel for use in an emergency.

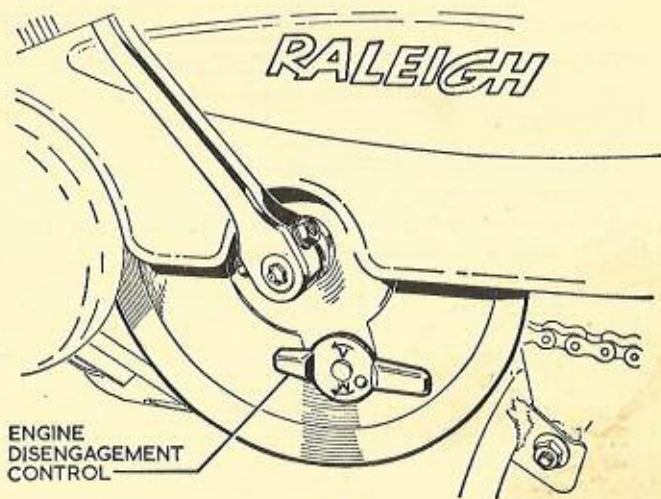

Fig. 3

Engine Disengagement Control

By movement of one simple control, the engine can be disconnected from the transmission and the machine pedalled as an ordinary cycle. To do so, simply turn the wing button on the bottom bracket pulley anti-clockwise in the direction of arrow "V."

To reconnect the engine, turn the button clockwise in the direction of arrow "M." Rocking the machine backwards and forwards will help the mechanism to engage.

RUNNING-IN INSTRUCTIONS

Your Raleigh Moped is one of the finest machines of its type and the very greatest care is taken in its manufacture and assembly.

The ultimate life and performance of your engine depends largely on the treatment it receives during the critical running-in period, and care and patience at this stage will pay dividends in the thousands of miles that follow.

During the first 300 miles observe the following rules:—

1. After the first 100 miles check the tension of the primary drive Vee-belt and adjust if necessary.
2. Try to avoid using full throttle and do not exceed 25 m.p.h.
3. Do not let the engine labour. Give it liberal pedal assistance when climbing hills or pulling away from rest.
4. Do not overheat the engine, particularly by running it for longer than necessary when the Moped is stationary and there is no air flowing over the engine to cool it.
5. It is beneficial to use a slightly larger proportion of oil with the petrol during this period. See section on lubrication on page 8 for details.
6. Check driving and pedal chain tension after the first twenty miles and subsequently at weekly intervals.

BEFORE TAKING THE MOPED ON THE ROAD

Legal Obligations

You must hold a current Driving Licence covering Group G vehicles, your Moped must have a current Road Fund Licence and you must be covered by insurance as required by the Road Traffic Acts.

Tyre Pressures

Make sure that the tyres are inflated to the correct pressures (see Technical Data).

Riding Comfort and Control

You cannot be a safe rider if you are not comfortable. The Raleigh Moped is designed to allow a range of adjustment at the handlebars and saddle to suit individual requirements. A few minutes spent "tailoring" the machine to fit you will be well repaid by increased comfort and better control of your Moped. Your weight is carried on the machine at three points, namely, the seat, the handlebars and the pedals. Try to arrange things so that each of these points carries its fair share of your weight. A little experiment will soon determine the most natural riding position.

Handlebar Adjustment

To adjust the handlebar height, loosen the central expander bolt (see Fig. 1) about three full turns and tap the bolt head with a wooden mallet to free the internal expander cone. Set the handlebars to the desired height, ensure that they are correctly in line with the front wheel and re-tighten the expander bolt.

Note—At least $2\frac{1}{2}$ " of the handlebar stem **MUST** remain within the steering head to provide adequate security.

Seat Adjustment

The seat may be adjusted for height after loosening the bolt on the seat pillar clip.

STARTING THE ENGINE

Turn on the fuel tap. Push the machine off its stand and then mount. Open the decompressor by turning the twistgrip forwards (in cold weather also operate the choke control) and pedal away as you would on a bicycle. When a speed of approximately 4 m.p.h. has been reached the automatic clutch will come into operation and begin to rotate the engine. Continue pedalling and turn the twistgrip towards you to open the throttle. The engine will now begin to fire and you can stop pedalling as soon as it is pulling evenly. Release the choke as soon as possible.

Note—The purpose of the centre stand is to support the machine only. It is **not** designed to withstand the additional weight of the rider sitting on the saddle to pedal start the engine.

RIDING THE MOPED

Anyone who can ride a bicycle will have no difficulty in learning to ride the Moped. This is simplicity itself due to the action of the automatic clutch. Control is solely by means of the twistgrip on the right-hand handlebar, plus of course, the brakes.

The automatic clutch is really two clutches in one. The primary clutch is connected to the engine crankshaft and its operation is therefore governed by engine speed. The secondary clutch is coupled *via* the Vee-belt and the driving chain to the rear wheel and its operation therefore depends on road speed. With the machine at rest, increasing the engine speed by opening the throttle causes the primary clutch to come into operation and starts the Moped moving. When a road speed of about 4 m.p.h. has been reached, the secondary clutch also comes into effect and locks up the drive, eliminating any slip.

The Moped will climb the majority of main road hills without any assistance, but if the speed falls below 8 m.p.h. the rider should help the engine by pedalling.

When it is required to stop, turn the twistgrip to "neutral" and then apply the brakes. As the speed falls below 4 m.p.h. the drive will disengage and the Moped will come to a halt with the engine idling. To stop the engine turn the twistgrip forwards to open the decompressor.

PERIODIC MAINTENANCE

See page 8 for details of lubricants to be used.

In order to obtain the best possible reliability, overall performance and length of service from your Moped, it is essential that the following simple maintenance tasks are carried out at the mileage intervals laid down.

Weekly

Check tension on both chains.

Check tyre pressures.

Check all controls (including brakes) for smooth and correct operation and lubricate or adjust as necessary.

Apply grease gun to nipple on left-hand side of bottom bracket axle.

Every 500 Miles

Clean sparking plug and set gap (.016"—.018").

Clean carburettor air filter.

Lubricate with a few drops of oil the freewheel, all working joints and moving parts in general and the exposed inner portions of all the control cables.

Apply grease gun to two nipples on telescopic front forks.

Every 1,000 Miles

Carry out 500-mile service.

Give ONE stroke of the grease gun to central nipple on automatic clutch.

Clean, lubricate and readjust chains.

Clean carburettor fuel filter.

Check belt tension and adjust if necessary.

Every 3,000 Miles

Carry out 500- and 1,000-mile services.

Check contact breaker points. Clean and adjust as necessary (.016"—.018").

Decarbonise and clean exhaust system.

Clean out wheel hubs and re-pack bearings with grease.

Clean and grease sparingly brake operating cams and spindles.

Every 6,000 Miles

Carry out 500-, 1,000- and 3,000-mile services.

Undertake full decarbonisation of engine and exhaust system.

Fit new sparking plug of recommended type.

LUBRICATION OPERATIONS IN DETAIL

See page 8 for lubricants to be used.

Control Cables and other Moving Parts

The exposed inner portions of all the control cables should be kept well oiled, particularly in the winter months. Oil the pivots of all the handlebar levers. Apply a few drops of oil through the pedal end caps. The pivot of the centre stand needs regular oiling owing to its exposed position.

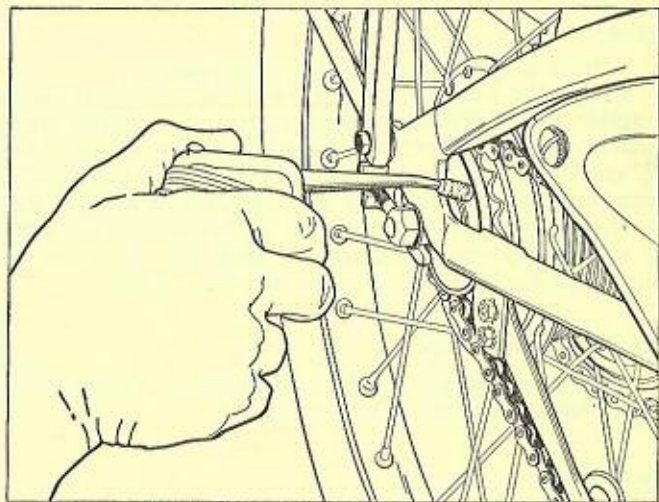

Fig. 4
Oiling the Freewheel

Freewheel

Every 500 miles clean the freewheel with a cloth moistened in petrol. With the machine tilted sideways apply oil to the gap between the outer and inner parts of the freewheel, at the same time rotating the outer part by turning the chain backwards to work the oil into the mechanism.

Automatic Clutch

The automatic clutch should be greased sparingly through the central grease nipple. Give one stroke only of the grease gun every 1,000 miles. Over-lubrication will cause faulty operation of the clutch due to excess grease on the friction linings.

Bottom Bracket Pulley Bearings

Grease through the nipple on the L.-H. side of the bottom bracket axle at weekly intervals.

Chains

Always keep the chains properly lubricated.

Check for wear by placing the chain on a level surface alongside a ruler and stretching it tight. 23 complete pitches (distance between centres of adjacent rollers) will come to the $11\frac{1}{2}$ " mark on the ruler when the chain is new. When the chain wears to a measurement of $11\frac{3}{4}$ " for 23 pitches replace the chain.

It is important when replacing a chain to make sure that the spring clip on the connecting link has its closed end pointing in the forward direction of chain travel.

Telescopic Front Forks

Apply a grease gun to the two nipples at the upper rear of the fork legs at 500-mile intervals.

Wheel Hubs

At intervals of 3,000 miles these should be cleaned out and the bearings re-packed with grease. At the same time the bearings should be checked to see that they are in a serviceable condition.

Brake Cam Spindle

While the hub is dismantled, the brake cam spindle should be removed and very lightly smeared with grease.

Important. Grease must not get on to the brake linings.

VARIOUS MAINTENANCE AND ADJUSTMENT OPERATIONS

Driving Belt Removal and Adjustment

To remove the belt, take off both fairings and the clutch guard. Slacken both upper and lower engine attachment bolts and pivot the engine rearwards to its fullest extent. Remove the belt, taking it off the bottom bracket pulley first.

To replace the belt, fit it first over the clutch pulley and then over the bottom bracket pulley.

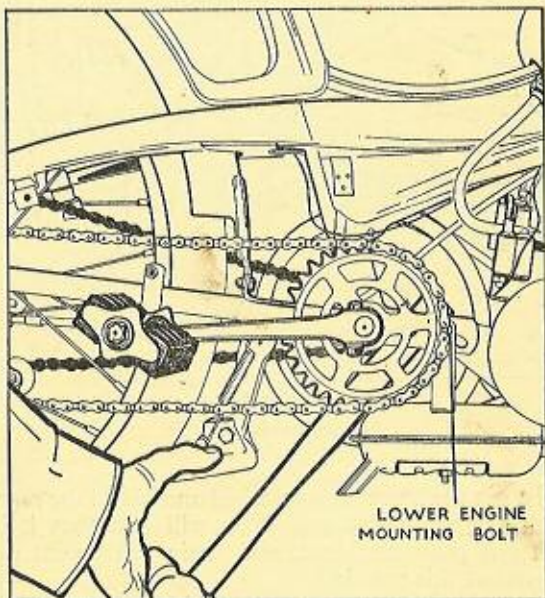

Fig. 5
Adjusting driving belt

To adjust the belt tension insert a suitable lever, such as a hammer handle, between the bottom bracket housing and the lower engine mounting and without using undue force, lever

the engine forward by the required amount. Tighten the bolts. When the belt is correctly tensioned, finger pressure on the belt midway between the pulleys should produce a trace of up and down movement.

Chain Adjustment

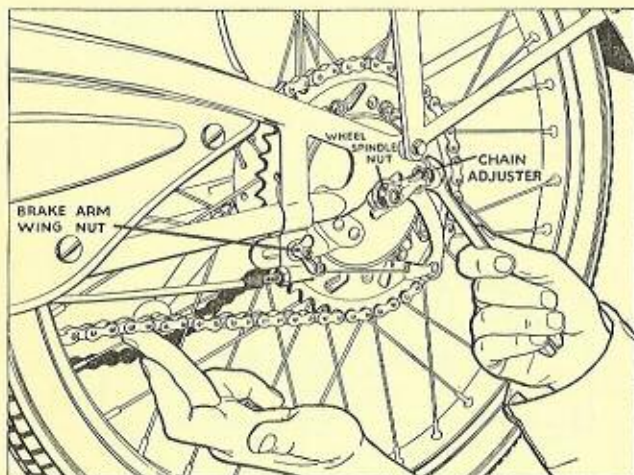

Fig. 6

Adjusting driving chain

First put the Moped on its stand and rotate the rear wheel to check the chain tension. You will find that it is least slack at one particular spot, and chain adjustment must be carried out at this position.

To adjust, loosen the rear wheel spindle nuts and the brake arm wing nut and slacken right off the brake adjustment. Slacken the pedal chain by loosening the two bolts holding the jockey wheel arm. Then with a 12 mm. spanner turn each chain adjuster by an equal amount, moving the wheel backwards or forwards in the slotted chain lug until $\frac{1}{2}$ " to $\frac{3}{4}$ " up and down movement is possible at the centre of the chain run.

Partially tighten the wheel spindle nuts and check the wheel alignment. If this is correct, tighten the spindle nuts and the brake arm wing nut and adjust the brake. Set the pedal chain to its tightest spot and adjust the jockey wheel to produce $\frac{1}{2}$ " to $\frac{3}{4}$ " vertical movement at the centre of the chain run.

WHEEL REMOVAL

Front Wheel

Slacken off the front brake adjuster and remove the cable from the cam lever. Disconnect the speedometer cable from the drive unit. Loosen the wheel spindle nuts and disengage the washers from their recesses in the fork ends. Withdraw the wheel from the forks. When refitting the front wheel ensure that the brake plate peg engages correctly with the slot in the right-hand fork end.

Rear Wheel

Slacken off the pedal chain jockey wheel and remove the brake arm wing nut and bolt. Unscrew the wheel spindle nuts far enough to enable the chain adjusters to be pulled out of the slots in the frame lugs and push the wheel forwards. Lift both chains from their sprockets and disconnect the rear brake cable. The wheel can now be withdrawn from the frame.

HANDLEBAR CONTROLS ADJUSTMENT

Throttle

Adjustment of the throttle is carried out at the cable adjuster on the top of the carburettor mixing chamber (8 mm. spanner). There must always be a slight amount of free play in the cable when the twistgrip is in the "neutral" position.

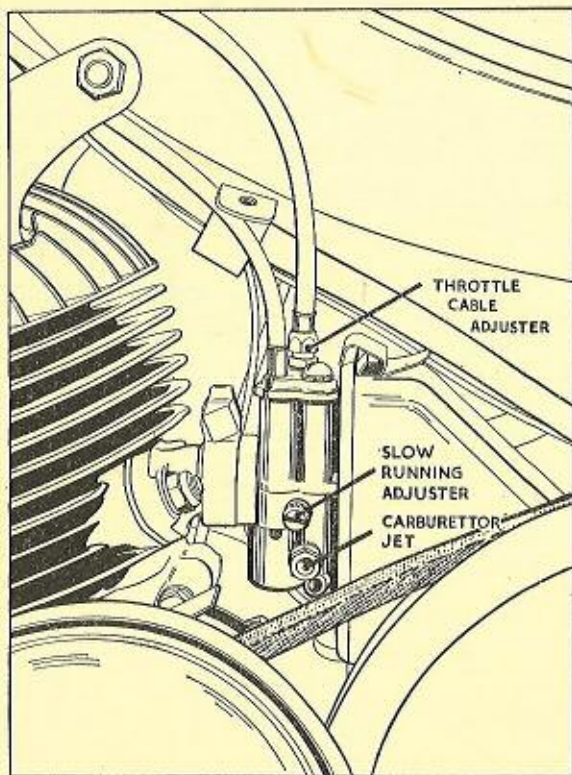

Fig. 7

Decompressor

This adjustment is carried out at the cable adjuster alongside the twistgrip on the handlebar. The control must open the valve sufficiently far (2 mm.) but there must also be slight free play in the cable to ensure that the valve closes completely. The setting of the twistgrip must always be such that the throttle closes to "neutral" position before the decompressor valve starts to open.

Engine Slow Running

When the twistgrip is turned to the "neutral" position the engine should run at a steady "tickover."

After removing the left-hand fairings, engine slow-running is set by turning the adjusting screw on the carburettor (clockwise to increase speed). The engine must be at working temperature when the adjustment is carried out.

Choke Control Cable

The cable should be adjusted at the pinch bolt on the handlebar lever to give approximately $\frac{1}{16}$ " free play.

Brakes

Adjusters are provided on the control cables. The adjustment should be such that the brakes come into operation with the minimum amount of movement at the levers but there must be no binding of the brake shoes. After adjustment the machine should be put on its stand and each wheel checked to see that it is able to turn freely.

CLEANING THE CARBURETTOR

Fuel Filters

First make certain that the fuel tap is turned off.

Unscrew the cap nut underneath the filter chamber and lift off the top cover (see fig. 8). Remove the filter gauze and wash in clean petrol. When replacing the top cover ensure that the gasket is undamaged and that the point of the float needle enters its recessed seating in the cover. Do not overtighten the cap nut.

Additional fuel filters are fitted in the fuel tap and on certain models in the fuel pipe. To clean these filters drain off the tank, remove the pipe and unscrew the tap. Each filter can then be cleaned by swilling in clean petrol and blowing through.

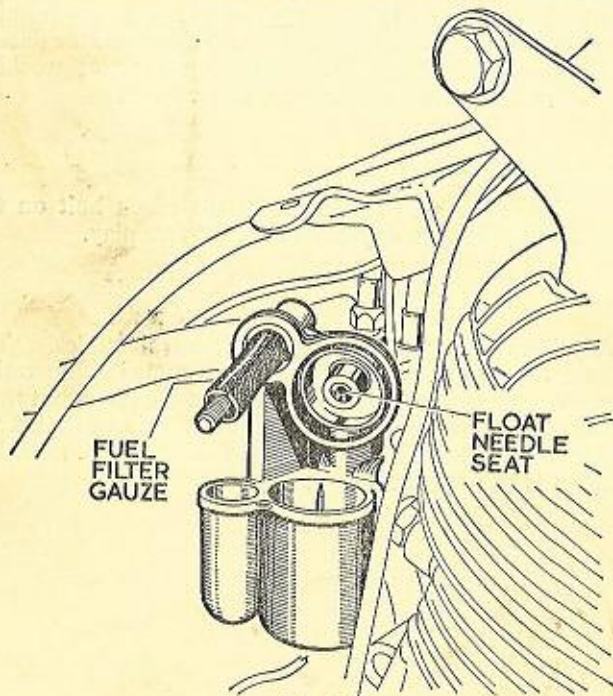

Fig. 8

Air Cleaner

Unclip the air cleaner body, remove the filter gauze and wash both parts in clean petrol.

Jet

Remove the jet by unscrewing from the carburettor body. Clean by blowing through the orifice. Never use a needle, pin or piece of wire, etc., to clear the jet, as this may enlarge it and upset carburation.

SERVICING THE IGNITION EQUIPMENT**Sparking Plug**

Always use the correct plug. (See Technical Data.)

At intervals of 500 miles check that the plug is clean and that the gap is set correctly. If it is necessary to adjust the gap, bend only the earth electrode and never the central electrode. These plugs are non-detachable types and are best cleaned by your Dealer, using a sand-blasting machine. Ensure that no small grains of sand remain in the plug when refitting.

Every 6,000 miles a new plug should be fitted since even if the old one still appears to be in good condition, its performance may have deteriorated.

Contact Breaker Points

Hold the magneto flywheel with a strap wrench and unscrew the central cap nut, which has a LEFT-HAND thread. The flywheel can then be pulled off its register on the cam, the cam itself remaining in place on the crankshaft.

Check the condition of the points and if oily or dirty, clean with a non-fluffy rag dipped in pure petrol or methylated spirits. If the points are blackened they can be cleaned by inserting a strip of very fine glass paper between them. Close the points on to the glass paper and draw it through several times with the rough side towards each point in turn.

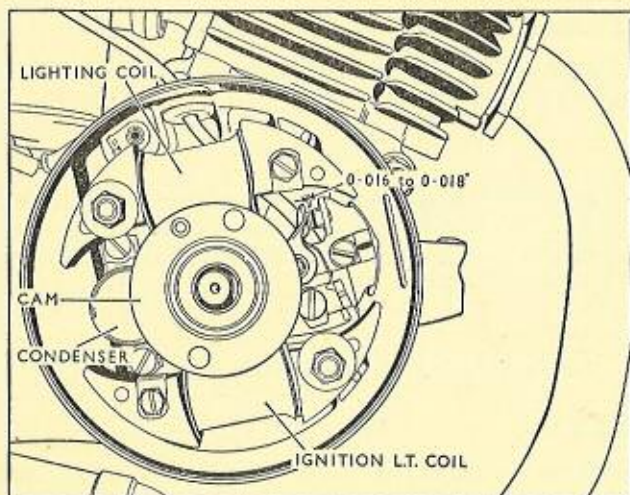

Fig. 9

If the points are slightly pitted they can be cleaned up, using a special contact file. If the pitting is extensive the contact breaker should be replaced.

To check the contact breaker points gap, rotate the engine until the points are fully open and insert a feeler gauge between them. To adjust, loosen the fixed contact locking screw and move the contact as required by inserting the blade of a screwdriver into the slot in the spring clip and twisting slightly in either direction. Tighten the locking screw and re-check the gap.

Before replacing the flywheel, lubricate the pivot of the moving contact with just a trace of light machine oil.

HEADLAMP ALIGNMENT

The headlamp should be adjusted so that its beam strikes the road at a distance of approximately 18 ft. in front of the machine.

The lamp can be tilted to the required position after loosening the clamping bolts.

DECARBONISING

The Importance of Decarbonising

With any two-stroke, build-up of carbon in the engine and exhaust system will cause a marked deterioration in performance.

In addition, if the exhaust system is obstructed so that the hot exhaust gases cannot freely escape, this will have a detrimental effect on the life of the engine.

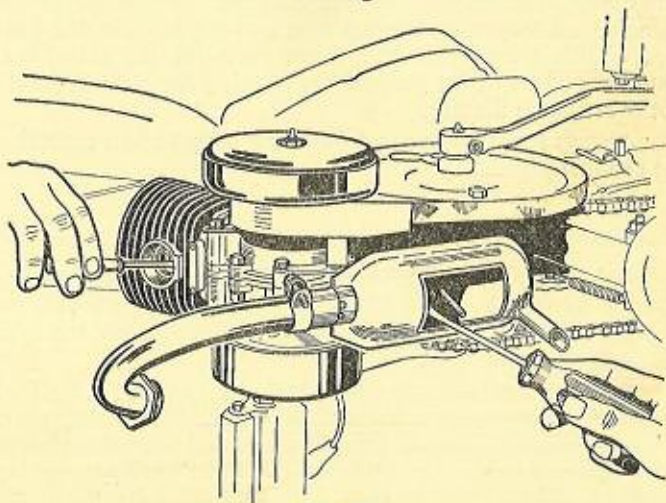

Fig. 10

It is, therefore, most important that the work of removing the deposits of carbon is not neglected. This should be carried out as a matter of routine and not left until a fall off in power makes it necessary.

Decarbonising the Exhaust System

At intervals of about 3,000 miles, or more frequently if the machine is used mainly for short runs, or stop and start riding, the deposits of carbon should be removed from the exhaust system.

Remove the exhaust pipe after unscrewing the large exhaust port nut and slackening the silencer clip. Scrape the carbon out of the pipe, using a suitable implement. Turn the piston to its lowest position and clean out the exhaust port using a small scraper of soft metal such as aluminium or copper to avoid scratching the soft material of the cylinder. Take care to keep the dislodged carbon out of the cylinder.

The silencer is fitted with a removable cover plate (see fig. 10). Remove the retaining nut and washer and prise off the plate, taking care not to damage or distort the joint faces. The carbon should now be scraped from the interior of the silencer, not forgetting the tail pipe and the holes in the inlet pipe, which must be clear. When replacing the plate, seal round the edges with a proprietary jointing compound and do not overtighten the nut.

Always fit a new exhaust port ring gasket when replacing the exhaust pipe.

Decarbonising the Engine

This does not require attention as frequently as the exhaust system but should be undertaken at intervals of approximately 6,000 miles, dependent of course on the type of use the machine receives.

Remove the fairings, disconnect the sparking plug lead and the decompressor cable and take out the sparking plug. Remove the upper engine mounting bolt and the four cylinder head nuts and washers and take off the upper engine mounting brackets. The engine is now only supported by the lower mounting bolt and care should be taken to prevent it swinging too far forward and hanging on the carburettor cables. Now withdraw the cylinder head, taking great care not to lift the cylinder in the process and thus break the joint between the cylinder and the crankcase.

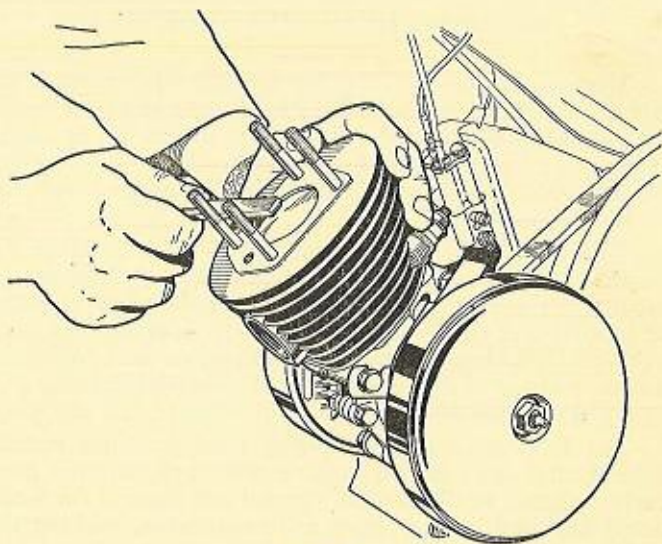

Fig. 11

For the actual work of removing the deposits of carbon a soft metal (copper, aluminium, etc.) scraper should be used. Hold the cylinder and turn the flywheel to bring the piston to the top of its stroke. Scrape the carbon from the crown of the piston. Turn the flywheel until the piston is at the bottom of its stroke. Clean out the carbon from the exhaust port. Scrape the carbon from the cylinder head combustion chamber. Remove decompressor valve and clean valve stem. Examine seating surfaces and if any pitting or burning is noticeable grind in the valve, using a fine grinding paste. Wash off all traces of grinding paste with petrol and refit valve.

Remove the loose carbon from all the components, preferably with a jet of compressed air, or by blowing with a tyre pump. When refitting the cylinder head, use a new cylinder head gasket and tighten the cylinder head nuts alternately, a little at a time, to avoid any distortion. Refit the remaining components in the reverse sequence.

STEERING HEAD ADJUSTMENT

The steering head is correctly adjusted when there is no trace of play in the bearing but the handlebars still turn freely. If the adjustment is too tight the steering will be stiff in operation and the bearings may be damaged. If too loose, there will be a judder when the front brake is applied and the steering may wobble.

To adjust, slacken the steering head locknut and turn the knurled adjusting collar as required, clockwise to decrease the amount of play and anti-clockwise for more play. Tighten the locknut and check the adjustment by applying the front brake and rocking the machine backwards and forwards, with your finger on the gap between the adjusting collar and the top frame cup where it will be possible to feel any play.

The lubrication of the steering head does not require frequent attention but at a major overhaul the steering head bearings should be dismantled, cleaned and checked for wear. Renew any parts as necessary and re-assemble, packing the bearings with grease.

CARE OF TYRES

Always maintain the recommended inflation pressures in your tyres. Check the pressures with a gauge when the tyres are cold and not when they have attained their normal running temperature.

Always replace the valve caps, thereby sealing the valve mouth and protecting the core. Screw the caps down finger tight only.

Drive carefully and avoid fierce braking or cornering.

Inspect the tyres regularly and remove any nails, flints or any other object embedded in the tread.

Keep the tyres free from oil, grease, or paraffin. If contaminated, clean with a cloth moistened in a little petrol.

Do not neglect tyre injuries. If a tyre is cut or damaged, have it suitably repaired as soon as possible.

CLEANING THE MOPED

Mix up a weak solution of household "washing-up" detergent in a bucket of warm water and apply it liberally to the paintwork and bright parts.

Allow this to soak thoroughly into the traffic film but not to dry. Then lightly rise off, using plenty of clean water.

Now sponge over with a clean sponge and plain water.

Finally use a wash leather to remove any smear marks and to dry off the machine.

The paintwork should then be treated with a good quality wax polish and the bright parts polished with a duster.

When washing the Moped, care should be taken to prevent water getting into the brakes, "electrics" and working parts. When taking your machine on the road again, however, check your brakes. If they have been rendered inoperative by water, a few moments running with the brakes applied will generate enough heat to dry them out.

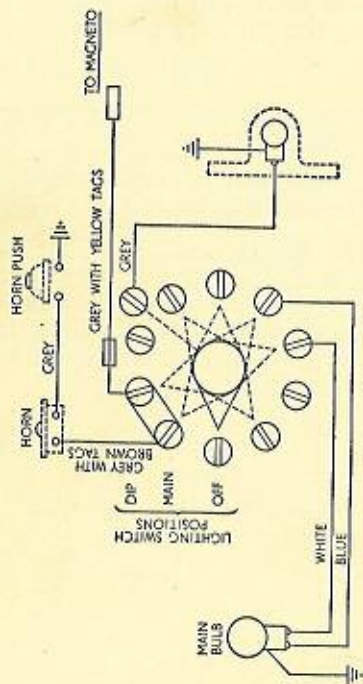

Fig. 12
Electrical Circuit Diagram

FAULT FINDING

If the instructions contained in this book are followed conscientiously, and the machine is properly maintained it is unlikely that trouble will arise. In the event of any difficulty being experienced, it should not be hard to remedy if it is tackled systematically with the aid of the following fault finding procedure.

If the Engine will not Start or Stops of its Own Accord

It may be because of:—

(A) Faulty carburation due to:—

- (1) Absence of fuel: refill the tank.
- (2) Fuel tap not turned on: open the tap.
- (3) Carburettor loose causing air leak: tighten.
- (4) Carburettor jet blocked: remove and clean the jet. At the same time clean the float chamber and filter and blow through the internal passages in the carburettor.
- (5) Fuel feed line blocked: clean out fuel pipe, tap and filters, preferably by blowing through with compressed air. Before replacing the pipe on the carburettor connection, turn on the tap to verify that fuel is flowing.
- (6) Fuel filler cap air vent blocked: clear vent.
- (7) Flooded carburettor: turn off the fuel tap, dry the carburettor by opening the throttle wide and turning the engine over as rapidly as possible. If it does not fire after a few attempts, dry and clean the sparking plug. Before replacing, turn over the engine several times in order to eject the excess fuel from the cylinder. Then turn on the fuel tap again and carry out normal starting procedure. Should flooding still occur, check the float, float needle and seating.

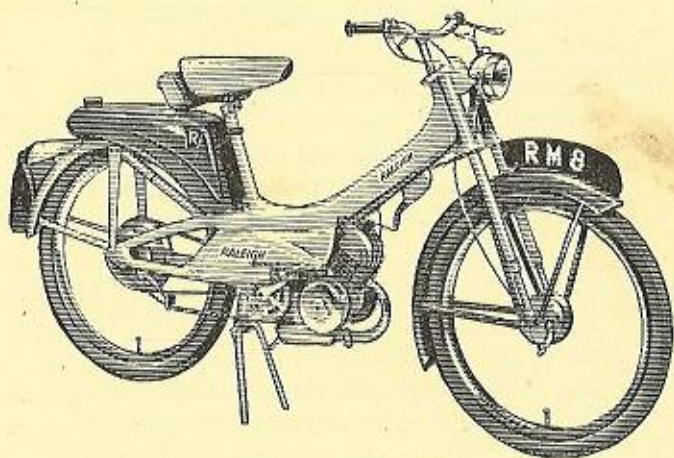

RALEIGH AUTOMATIC MARK II, MODEL R M 8

(C) Mechanical trouble, as follows:—

- (20) Leakage at a crankcase joint, or at the crankshaft oil seals. Leakage at cylinder head gasket or at decompressor valve: check these possibilities preferably with the aid of a qualified mechanic.

If the Engine Starts, but Stops Immediately

- (21) In winter with a cold engine: let the engine warm up with the cold start control in operation.

If the Engine Stops when the Throttle is Opened

- (22) Engine still cold: allow it to warm up.
(23) Carburettor jet blocked: clean it.
(24) Fuel having difficulty in reaching carburettor: clean petrol pipe, tap and filters (see also points 1, 4, 5 and 6).

If the Engine does not Run Properly or Lacks Power

- (25) Mixture too weak: see points 1, 3, 4, 5, 6 and 20. Jet too small: fit one size larger jet.
(26) Mixture too rich (air cleaner blocked with dirt, carburettor badly adjusted, float not maintaining correct fuel level, jet loose): wash the air cleaner in petrol or adjust or repair the carburettor as necessary. Jet too large: fit one size smaller jet.
(27) Too much oil in petrol mixture: correct the mixture.
(28) Sparking plug dirty or of unsuitable type, or with electrodes corroded or with incorrect gap: clean plug and set gap, or if necessary replace plug.
(29) Contact breaker, condenser or ignition coil not functioning properly: have them checked.
(30) Exhaust port or exhaust system choked with carbon: decarbonise and thoroughly clean.

- (31) Sparking plug loose in head: tighten securely.
- (32) Mechanical trouble: see points 3 and 20.
- (33) Piston rings gummed-in or excessively worn: clean grooves. Clean rings or replace if necessary.

If the Engine Four-strokes Excessively

- (34) Mixture too rich: remedy as indicated in point 26.
- (35) Exhaust system choked: remedy as indicated in point 30.

Note—If the four-stroking is caused by too rich a mixture, this can easily be verified by turning off the fuel tap whilst riding the machine. Just before the engine stops due to lack of fuel, it will begin to fire correctly. If this does not prove to be the cause, then it is probably due to carbon deposits obstructing the exhaust system.

Misfiring

- (36) Fault with ignition equipment: check all items.
- (37) Fuel feed deficiency producing a weak mixture (usually accompanied by spitting back in the carburettor): see points 1, 3, 4, 5 and 6).

If the Engine Stops of its Own Accord

- (38) Fuel feed deficiency or absence of fuel if the stoppage is preceded by spitting back in the carburettor and back-firing in the exhaust.
- (39) Ignition defect if the stoppage is preceded by a bout of misfiring.

If the Engine Races but the Machine does not Increase Speed

- (40) Driving belt slipping: check condition of belt and adjust or renew as required. (The belt can be contaminated by grease or oil due to excessive lubrication of the transmission).



IceniCAM Information Service

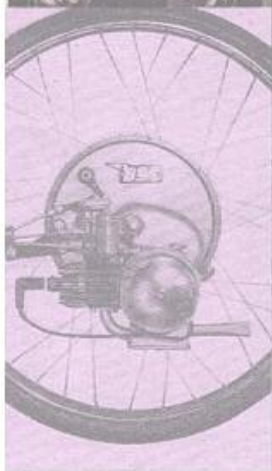

www.icenicam.org.uk